

Rexroth IndraDyn S MSK Synchronous Motors

R911296289
Edition 08

Project Planning Manual



Title	Rexroth IndraDyn S MSK Synchronous Motors
Type of Documentation	Project Planning Manual
Document Typecode	DOK-MOTOR*-MSK*****-PR08-EN-P
Internal File Reference	RS-e376b79b0a6846ac00f6d325fdb2ed7-6-en-US-8
Purpose of Documentation	This documentation... <ul style="list-style-type: none"> explains the features of the product, possibilities for use, operating conditions and operational limits of MSK motors. contains technical data regarding available MSK motors. provides information regarding product selection, handling and operation

Record of Revision

Edition	Release Date	Notes
DOK-MOTOR*-MSK*****-PR01-EN-P	06/2004	First edition
DOK-MOTOR*-MSK*****-PR02-EN-P	10/2004	Revision / supplement
DOK-MOTOR*-MSK*****-PR03-EN-P	02/2005	Revision, amendment, not publicized.
DOK-MOTOR*-MSK*****-PR04-EN-P	06/2005	Revision / supplement
DOK-MOTOR*-MSK*****-PR05-EN-P	02/2006	Revision / supplement
DOK-MOTOR*-MSK*****-PR06-EN-P	12/2006	Revision / supplement fan units
DOK-MOTOR*-MSK*****-PR07-EN-P	06/2008	Revision / supplement
DOK-MOTOR*-MSK*****-PR08-EN-P	09/2008	Revision / supplement

Copyright © 2008 Bosch Rexroth AG

Copying this document, giving it to others and the use or communication of the contents thereof without express authority, are forbidden. Offenders are liable for the payment of damages. All rights are reserved in the event of the grant of a patent or the registration of a utility model or design (DIN 34-1).

Validity The specified data is for product description purposes only and may not be deemed to be guaranteed unless expressly confirmed in the contract. All rights are reserved with respect to the content of this documentation and the availability of the product.

Published by Bosch Rexroth AG
Bgm.-Dr.-Nebel-Str. 2 ■ 97816 Lohr a. Main, Germany
Phone +49 (0)93 52 / 40-0 ■ Fax +49 (0)93 52 / 40-48 85
<http://www.boschrexroth.com/>
Dept.BRC/EDM2 (JW)

Note This document has been printed on chlorine-free bleached paper.

Table of Contents

	Page
1 Introduction.....	7
1.1 Introduction to the Product IndraDyn S.....	7
1.2 Conformity.....	8
1.3 About this Documentation.....	10
2 Important Instructions on Use.....	13
2.1 Intended Use	13
2.1.1 Introduction.....	13
2.1.2 Areas of Use and Application.....	13
2.2 Inappropriate Use.....	14
3 Safety Instructions for Electric Drives and Controls.....	15
3.1 Safety Instructions - General Information.....	15
3.1.1 Using the Safety Instructions and Passing them on to Others.....	15
3.1.2 How to Employ the Safety Instructions.....	15
3.1.3 Explanation of Warning Symbols and Degrees of Hazard Seriousness.....	16
3.1.4 Hazards by Improper Use.....	17
3.2 Instructions with Regard to Specific Dangers.....	18
3.2.1 Protection Against Contact with Electrical Parts and Housings.....	18
3.2.2 Protection Against Electric Shock by Protective Extra-Low Voltage.....	19
3.2.3 Protection Against Dangerous Movements.....	19
3.2.4 Protection Against Magnetic and Electromagnetic Fields During Operation and Mounting.....	22
3.2.5 Protection Against Contact with Hot Parts.....	22
3.2.6 Protection During Handling and Mounting.....	22
3.2.7 Battery Safety.....	23
3.2.8 Protection Against Pressurized Systems.....	23
4 Technical Data.....	25
4.1 Definition of Parameters	25
4.1.1 Parameters on the Data Sheet.....	25
4.1.2 60 K and 100 K Parameters.....	28
4.1.3 Operating Modes	29
4.1.4 Duty Cycle.....	29
4.1.5 Example of a Characteristic Curve of a Motor.....	30
4.2 MSK030B - Technical Data	31
4.3 MSK030C - Technical Data	33
4.4 MSK040B - Technical Data.....	35
4.5 MSK040C - Technical Data.....	38
4.6 MSK050C - Technical Data.....	41
4.7 MSK050C - Technical Data.....	44
4.8 MSK060B - Technical Data.....	47
4.9 MSK060C - Technical Data.....	50
4.10 MSK061B - Technical Data.....	53

Table of Contents

	Page
4.11	MSK061C - Technical Data..... 55
4.12	MSK070C - Technical Data..... 58
4.13	MSK070D - Technical Data..... 61
4.14	MSK070E - Technical Data..... 64
4.15	MSK071C - Technical Data 67
4.16	MSK071D - Technical Data..... 71
4.17	MSK071E - Technical Data..... 75
4.18	MSK075C Technical Data..... 79
4.19	MSK075D Technical Data..... 82
4.20	MSK075E Technical Data..... 85
4.21	MSK076C - Technical Data 89
4.22	MSK100A - Technical Data 92
4.23	MSK100B - Technical Data..... 95
4.24	MSK100C - Technical Data..... 99
4.25	MSK100D - Technical Data 102
4.26	MSK101C - Technical Data..... 105
4.27	MSK101D - Technical Data..... 109
4.28	MSK101E - Technical Data..... 113
4.29	MSK103A - Technical Data 117
4.30	MSK103B - Technical Data 119
4.31	MSK103D - Technical Data 121
4.32	MSK131B - Technical Data..... 123
4.33	MSK131D - Technical Data..... 125
5	Specifications..... 127
5.1	Technical Design 127
5.2	MSK030 Specifications..... 128
5.3	MSK040 Specifications..... 129
5.4	MSK050 Specifications..... 130
5.5	MSK060 Specifications..... 131
5.6	MSK061 Specifications..... 132
5.7	MSK070 Specifications..... 133
5.8	MSK071 Specifications..... 134
5.9	MSK071 Specifications Liquid Cooling..... 135
5.10	MSK075 Specifications..... 136
5.11	MSK075 Specifications Liquid Cooling..... 137
5.12	MSK076 Specifications..... 138
5.13	MSK100 Specifications..... 139
5.14	MSK101 Specifications..... 140
5.15	MSK101 Specifications Liquid Cooling..... 141
5.16	MSK103 Specifications..... 142
5.17	MSK131 Specifications..... 143
6	Type Codes..... 145
6.1	MSK Type Code - Structure and Description..... 145

Table of Contents

	Page
6.2	MSK030 Type Code..... 148
6.3	MSK040 Type Code..... 150
6.4	MSK050 Type Code..... 152
6.5	MSK060 Type Code..... 154
6.6	MSK061 Type Code..... 156
6.7	MSK070 Type Code..... 158
6.8	MSK071 Type Code..... 160
6.9	MSK075 Type Code..... 162
6.10	MSK076 Type Code..... 164
6.11	MSK100 Type Code..... 166
6.12	MSK101 Type Code..... 168
6.13	MSK103 Type Code 170
6.14	MSK131 Type Code..... 172
7	Accessories and Options..... 175
7.1	Motor Encoder..... 175
7.1.1	General Information..... 175
7.1.2	Technical Data of the Motor Encoder..... 175
7.2	Holding Brakes..... 176
7.3	Fan Units for MSK Motors..... 177
7.3.1	Field of Application..... 177
7.3.2	Technical Data..... 178
7.3.3	Select the Fan Unit..... 179
7.3.4	Electrical Connection..... 181
	Connection 1-phase..... 181
	Connection 3-phase..... 182
7.3.5	Order..... 183
7.3.6	Specifications 184
	MSK060 Fan Unit Axial..... 184
	MSK060 Fan Unit Radial..... 185
	MSK061 Fan Unit Axial..... 186
	MSK061 Fan Unit Radial..... 187
	MSK070 Fan Unit Axial..... 188
	MSK070 Fan Unit Radial..... 189
	MSK071 Fan Unit Axial..... 190
	MSK071 Fan Unit Radial..... 191
	MSK075 Fan Unit Axial..... 192
	MSK075 Fan Unit Radial..... 193
	MSK076 Fan Unit Axial..... 194
	MSK076 Fan Unit Radial..... 195
	MSK100 Fan Unit Axial..... 196
	MSK100 Fan Unit Radial..... 197
	MSK101 Fan Unit Axial..... 198
	MSK101 Fan Unit Radial..... 199
	MSK131 Fan Unit Axial..... 200
7.3.7	Assembly..... 202

Table of Contents

	Page
Assembly Fan Unit Axial, Flange dimension 116/140.....	202
Assembly Fan Unit Axial, Flange Dimension 192.....	204
Assembly Fan Unit Axial, Flange Dimension 116/140.....	206
Assembly Fan Unit Radial, Flange Dimension 192.....	208
Assembly Fan Unit Axial, Flange Dimension 260.....	210
7.4 Gearboxes.....	211
7.5 Sealing Air Connection.....	212
7.5.1 General Information	212
7.5.2 Technical Data.....	212
7.5.3 Ording Designations and Assignment.....	212
7.5.4 Mounting Instructions.....	213
Retrofitting of IndraDyn S - SUP-M01-MSK	213
Retrofitting of IndraDyn S - SUP-M02-MSK.....	213
8 Connection Technique.....	215
8.1 Electric Connection Technique Overview.....	215
8.2 Power Connector Size 1.....	216
8.2.1 Technical data - RLS1100.....	216
8.2.2 Technical data - RLS1101.....	217
8.2.3 Technical data - RLS1108.....	218
8.3 Power Connector Size 1.5.....	219
8.3.1 Technical data - RLS1200.....	219
8.3.2 Technical data - RLS1201.....	220
8.4 Power Connector Size 2.....	221
8.4.1 Technical data - RLS1300.....	221
8.4.2 Technical data - RLS1301.....	222
8.5 Encoder Connector.....	223
8.5.1 Technical data - RGS1000 / RGS1003.....	223
8.5.2 Technical data - RGS1001.....	224
8.6 Connecting Cables.....	225
8.6.1 Ready-Made Connection Cables.....	225
8.7 Connection Technique Fan Units.....	225
8.8 Connection Technique Liquid Cooling.....	225
9 Operating Conditions and Application Notes.....	227
9.1 Ambient Conditions	227
9.1.1 Setup Elevation and Ambient Temperature.....	227
9.1.2 Humidity / Temperature	228
9.1.3 Vibration.....	228
9.1.4 Shock.....	228
9.2 Degree of Protection.....	229
9.3 Design and Installation Positions.....	231
9.4 Compatibility with Foreign Materials.....	231
9.5 Housing Varnish.....	231
9.6 Output Shaft.....	232

Table of Contents

	Page
9.6.1 Plain Shaft.....	232
9.6.2 Output Shaft with Key.....	232
9.6.3 Output Shaft with Shaft Sealing Ring.....	232
9.7 Bearing and Shaft Load.....	234
9.7.1 Radial Load, Axial Load.....	234
9.7.2 Shaft Load MSK Motors.....	236
9.8 Bearing Lifetime.....	239
9.9 Attachment of Drive Elements.....	240
9.10 Holding Brakes	242
9.10.1 Holding Brake Electrically-Released.....	242
9.10.2 Holding Brakes - Notes Regarding Safety.....	242
9.10.3 Layout of Holding Brakes.....	243
9.10.4 Holding Brake–Commissioning and Maintenance Instructions	244
9.11 Acceptances and Authorizations.....	245
9.11.1 CE Symbol.....	245
9.11.2 UR, cUR Listing.....	245
9.11.3 CCC (China Compulsory Certification).....	246
9.12 Motor Cooling System.....	246
9.12.1 Natural Convection.....	246
9.12.2 Fan Units.....	246
9.12.3 Liquid Cooling.....	246
General Information.....	246
Operating Pressure.....	247
Coolants.....	248
Coolant Additives.....	248
Used Materials.....	250
Coolant Inlet Temperature.....	250
9.13 Motor Temperature Monitoring.....	250
9.13.1 General Information.....	250
9.13.2 Temperature Sensor.....	251
10 Handling, Transport and Storage.....	253
10.1 State of Delivery.....	253
10.1.1 General Information.....	253
10.1.2 Inspection at the Factory.....	253
10.1.3 Test Realized by the Customer.....	253
10.2 Identification and Check of the Supplied Goods.....	253
10.2.1 Shipping Documents and Delivery Note.....	253
10.2.2 Type Plate.....	254
10.3 Handling of the Equipment.....	254
10.4 Transport of the Equipment.....	255
10.5 Storage of the Equipment.....	256
11 Installation.....	257
11.1 Safety.....	257

Table of Contents

	Page
11.2 Skilled Personnel.....	257
11.3 Mechanical Attachment.....	257
11.3.1 Flange Assembly.....	257
11.3.2 Assembly Preparation.....	258
11.3.3 Motor Assembly	259
11.4 Electrical Connection – Connecting the Motor.....	259
11.4.1 General Information.....	259
11.4.2 Attaching the Connectors.....	259
11.4.3 Adjusting the Output Direction.....	260
12 Commissioning, Operation and Maintenance	261
12.1 Commissioning.....	261
12.2 Operation.....	261
12.3 Deactivation.....	261
12.4 Maintenance.....	262
12.4.1 General Information.....	262
12.4.2 Cleaning.....	262
12.4.3 Bearings.....	262
12.4.4 Connecting Cables.....	263
12.5 Troubleshooting.....	263
12.6 Dismantling.....	263
13 Environmental Protection and Disposal	265
13.1 Environmental Protection.....	265
13.2 Disposal.....	265
14 Appendix.....	267
14.1 List of Standards.....	267
15 Service and Support.....	269
Index.....	271

1 Introduction

1.1 Introduction to the Product IndraDyn S

IndraDyn S servomotors set new standards. Many innovations in synchronous servomotors combine past experiences and the most up-to-date motor technology to create a new standard.

IndraDyn S servomotors are characterized by

- dynamics
- a compact construction
- a high torque density
- an extremely high degree of precision due to new optical encoder systems

IndraDyn S motors are available in the following power spectrum:

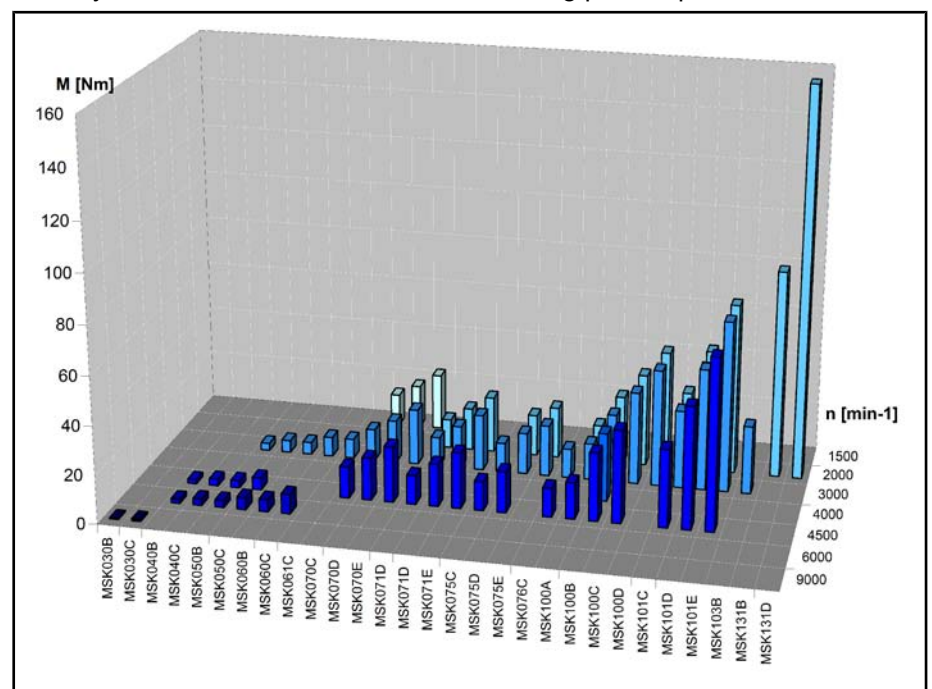

Fig. 1-1: MSK power gradation

Introduction

1.2 Conformity

<p>Electric Drives and Controls Hydraulics Linear Motion and Assembly Technologies Pneumatics Service</p>																							
<p>Konformitätserklärung im Sinne der EG-Niederspannungsrichtlinie 2006/95/EG, Anhang III B Produkt/Product/Produit: MSK</p>		<p>TC 30318-0 2008-07-16</p>																					
<p>Declaration of Conformity as per EC Low-Voltage directive 2006/95/EC, Attachment III B Déclaration du fabricant conformément à la directive "CE" relative à la basse tension 2006/95/EC, Annexe III B</p>																							
<p>Hiermit erklären wir in alleiniger Verantwortung, dass das Produkt</p>	<p>Assuming sole responsibility, we herewith declare that the product</p>	<p>Par la présente, nous déclarons sous notre propre et unique responsabilité que le produit</p>																					
<table border="1" style="width: 100%; border-collapse: collapse;"> <tr> <td style="width: 5%; text-align: center;">1</td> <td style="width: 35%;"> Produkt: Product: Produit: </td> <td style="width: 60%;"> AC-Motor AC motor Moteur AC </td> </tr> <tr> <td style="text-align: center;">2</td> <td> Hersteller: Manufacturer: Constructeur: </td> <td> Bosch Rexroth Electric Drives and Controls GmbH Bürgermeister-Dr.-Nebel-Straße 2 97816 Lohr a. Main / Germany </td> </tr> <tr> <td style="text-align: center;">3</td> <td>Typ / Type:</td> <td>MSK030, 040, 050, 060, 061, 070, 071, 075, 076, 100, 101, 103, 131</td> </tr> <tr> <td style="text-align: center;">4</td> <td> ab Herstellungsdatum: from date of manufacture: à partir de la date de fabrication: </td> <td>2004-01-01</td> </tr> <tr> <td style="text-align: center;">5</td> <td> Angewendete Normen / Applicable standard / Normes utilisées Norm / Standard / Norme Titel / Title / Titre Ausgabe / Edition </td> <td></td> </tr> <tr> <td></td> <td>EN 60034-1</td> <td>Rotating electrical machines – Part 1: Ratings and performance 2004</td> </tr> <tr> <td></td> <td>EN 60034-5</td> <td>Rotating electrical machines – Part 5: Degrees of protection provided by integral design of rotating electrical machines (IP-Code) - Classification 2001 + A1:2007</td> </tr> </table>			1	Produkt: Product: Produit:	AC-Motor AC motor Moteur AC	2	Hersteller: Manufacturer: Constructeur:	Bosch Rexroth Electric Drives and Controls GmbH Bürgermeister-Dr.-Nebel-Straße 2 97816 Lohr a. Main / Germany	3	Typ / Type:	MSK030, 040, 050, 060, 061, 070, 071, 075, 076, 100, 101, 103, 131	4	ab Herstellungsdatum: from date of manufacture: à partir de la date de fabrication:	2004-01-01	5	Angewendete Normen / Applicable standard / Normes utilisées Norm / Standard / Norme Titel / Title / Titre Ausgabe / Edition			EN 60034-1	Rotating electrical machines – Part 1: Ratings and performance 2004		EN 60034-5	Rotating electrical machines – Part 5: Degrees of protection provided by integral design of rotating electrical machines (IP-Code) - Classification 2001 + A1:2007
1	Produkt: Product: Produit:	AC-Motor AC motor Moteur AC																					
2	Hersteller: Manufacturer: Constructeur:	Bosch Rexroth Electric Drives and Controls GmbH Bürgermeister-Dr.-Nebel-Straße 2 97816 Lohr a. Main / Germany																					
3	Typ / Type:	MSK030, 040, 050, 060, 061, 070, 071, 075, 076, 100, 101, 103, 131																					
4	ab Herstellungsdatum: from date of manufacture: à partir de la date de fabrication:	2004-01-01																					
5	Angewendete Normen / Applicable standard / Normes utilisées Norm / Standard / Norme Titel / Title / Titre Ausgabe / Edition																						
	EN 60034-1	Rotating electrical machines – Part 1: Ratings and performance 2004																					
	EN 60034-5	Rotating electrical machines – Part 5: Degrees of protection provided by integral design of rotating electrical machines (IP-Code) - Classification 2001 + A1:2007																					
<p>einschließlich des erforderlichen Zubehörs den Bestimmungen der EG-Richtlinie 2006/95/EG entspricht.</p> <p><u>Erläuterungen:</u> Dieses Produkt ist eine Einbaueinheit, die auf Grund ihrer Einbaueigenschaften nicht vornehmlich den Vorschriften für Endgeräte, Maschinen oder Anlagen entsprechen kann. Es darf daher nur zu Einbauzwecken verwendet werden.</p> <p>Die Bewertung der elektrischen und mechanischen Sicherheit, der Umwelteinflüsse (Fremdkörper, Feuchtigkeit) muss im eingebauten Zustand am Endprodukt erfolgen.</p>			<p>including the accessories required, complies with the requirements specified by EC directive 2006/95/EC.</p> <p><u>Explanatory notes:</u> This product is a built-in unit which, owing to its installation characteristics, is not able to comply with the regulations for complete apparatus, machines or installations from the outset. For this reason, it may only be used for built-in purposes.</p> <p>The product may only be assessed with regard to its electrical and mechanical safety as well as to environmental effects (foreign bodies, moisture) after it has been installed in the product intended for the final user.</p>			<p>accessoires nécessaires compris, satisfait aux dispositions de la directive CE 2006/95/EC.</p> <p><u>Explications:</u> Ce produit est un composant devant être encastré et qui, en tant que tel, peut ne pas correspondre aux prescriptions imposées pour appareils finaux, machines ou installations. En conséquence, ce produit ne doit être utilisé qu'à l'état encastré.</p> <p>L'évaluation de la sécurité électrique et mécanique ainsi que celle de l'influence exercée par des conditions ambiantes extérieures (corps étrangers, humidité) doivent être effectuées sur l'appareil final, après encastrement du produit.</p>																	
<p>© Bosch Rexroth AG 2008</p> <p style="writing-mode: vertical-rl; transform: rotate(180deg);">TC-30318-000-KOE_N_D3_2008-07-16.doc</p>			<p>Bosch Rexroth Electric Drives and Controls GmbH Bürgermeister-Dr.-Nebel-Straße 2 • 97816 Lohr a. Main Germany</p>																				
			<p>Page 1 / 2</p>																				

Fig. 1-2: Certificate of Conformity MSK (page 1)

Konformitätserklärung / Declaration of Conformity / Déclaration du fabricant conformément
MSK

Page 2 / 2
TC 30318 : 2008-07-16

Im eingebauten Zustand können sich die EMV-Eigenschaften dieses Produktes ändern. Deshalb ist für das Endprodukt (Endgerät, Maschine, Anlagen) eine Überprüfung der EMV-Eigenschaften durch den EndproduktHersteller zweckmäßig.

After the product has been installed, its EMC properties may change. Hence the product intended for the final user (complete apparatus, machines or installations) should be inspected with regard to its EMC properties by the manufacturer of the product intended for the final user.

En état monté, les propriétés CEM du présent produit peuvent subir des modifications. C'est pourquoi, il est recommandé au constructeur du produit final (appareils, machines, installations où est intégré le présent produit) d'effectuer un nouveau contrôle des propriétés CEM du produit final.

Lohr a. Main , den 2008-07-16
 Ort/place/lieu Datum/date

i.V.

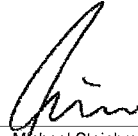

Michael Steinbrecher
 Leiter Qualitäts-Management/
 Head of Quality Management/
 Directeur Gestion Qualité

i.V.



Eberhard Schemm
 Entwicklungsbereichsleiter Antriebe/
 Head of Development Drives/
 Directeur Développement

Änderungen im Inhalt der Konformitätserklärung sind vorbehalten. Derzeit gültige Ausgabe auf Anfrage.
 We reserve the right to make changes in the conformity declaration. Presently applicable edition can be obtained upon request.
 Le fabricant se réserve le droit de modifier le contenu de la déclaration. Edition actuellement en vigueur demande.

Fig. 1-3: Certificate of Conformity MSK (page 2)

Introduction

1.3 About this Documentation

Document Structure This documentation contains safety regulations, technical data and operating instructions for IndraDyn S motors. The individual chapters can be subdivided into the following focal points:

Chapter / Description	Category
chapter 1 "Introduction" on page 7	
chapter 2 "Important Instructions on Use" on page 13	
chapter 3 "Safety Instructions for Electric Drives and Controls" on page 15	
chapter 4 "Technical Data" on page 25	
chapter 5 "Specifications" on page 127	
chapter 6 "Type Codes" on page 145	
chapter 7 "Accessories and Options" on page 175	
chapter 8 "Connection Technique" on page 215	
chapter 9 "Operating Conditions and Application Notes" on page 227	
chapter 10 "Handling, Transport and Storage" on page 253	
chapter 11 "Installation" on page 257	
chapter 12 "Commissioning, Operation and Maintenance " on page 261	
chapter 14 "Appendix" on page 267	
chapter 15 "Service and Support" on page 269	
Index	
Category	
General Information	
Safety	
Product description (for planners and designers)	
Practise (for operating and maintenance personnel)	

Fig. 1-4: Document structure

Additional Documentation As the case may be, you might need additional documentation referring to the used devices to project the drive systems of the MSK motor unit. Rexroth provides the entire product documentation in the Bosch Rexroth media directory (in PDF format) under <http://www.boschrexroth.com/various/utilities/mediadirectory/index.jsp>.

Standards This documentation refers to German, European and international technical standards. Documents and sheets on standards are subject to copyright protection and may not be passed on to third parties by Rexroth. If need be, please contact the authorized sales outlets or, in Germany, directly:

BEUTH Verlag GmbH

Burggrafenstrasse 6

10787 Berlin, Germany

Phone +49-(0)30-26 01-22 60, Fax +49-(0)30-26 01-12 60

Internet: <http://www.din.de/beuth>

Email: postmaster@beuth.de

External Systems Documentation for external systems which are connected to Rexroth components are not included in the scope of delivery and must be ordered directly from the respective manufacturers.

Your Feedback Your experiences are an essential part of the process of improving both the product and the documentation.

Please do not hesitate to inform us of any mistakes you detect in this documentation or of any modifications you might desire. We would appreciate your feedback.

Please send your remarks to:

Bosch Rexroth AG

Dep. BRC/EDM2

Buergermeister-Dr.-Nebel-Strasse 2

97816 Lohr, Germany

Fax +49 (0) 93 52 / 40-43 80

2 Important Instructions on Use

2.1 Intended Use

2.1.1 Introduction

Rexroth products are developed and manufactured according to the state of the art. Before they are delivered, they are inspected to ensure that they operate safely.



WARNING

Personal injury and property damage caused by inappropriate use of the products!

The products must only be used as intended. If they are not used as intended, situations may arise that result in personal injuries or damage to property.



Rexroth, as the manufacturer, does not provide any warranty, assume any liability, or pay any damages for damage caused by products not being used as intended. Any risks resulting from the products not being used as intended are the sole responsibility of the user.

Before using Rexroth products, the following condition precedent must be fulfilled so as to ensure that they are used as intended:

- Everyone who in any way whatsoever handles one of our products must read and understand the corresponding notes regarding safety and regarding the intended use.
- If the products are hardware, they must be kept in their original state, i.e. no constructional modifications must be made. Software products must not be decompiled; their source codes must not be modified.
- Damaged or improperly working products must not be installed or put into operation.
- It must be ensured that the products are installed according to the regulations specified in the documentation.

2.1.2 Areas of Use and Application

Rexroth IndraDyn A series asynchronous motors ApplicationsMSK are designed to be used as rotary main and servo drive motors. The following are typical fields of application:

- Machine tools
- Printing and paper-processing machines,
- Packaging and Food-processing machines,
- Metal-forming machines
- Robotics

Device types with different driving powers and different interfaces are available for an application-specific use of the motors.

Controlling and monitoring of the motors may require connection of additional sensors and actuators.

Important Instructions on Use



MSK The motors must only be used with the accessories specified in this documentation. Components that are not explicitly mentioned must neither be attached nor connected. The same is true for cables and lines.

The operation must only be carried out in the explicitly mentioned configurations and combinations of the component and with the software and firmware specified in the corresponding functional description.

Any connected drive control device must be programmed before startup in order to ensure that the motor executes the functions specifically to the particular application.

MSK The motors may only be operated under the assembly, mounting and installation conditions, in the normal position, and under the environmental conditions (temperature, degree of protection, humidity, EMC etc.) specified in this documentation.

2.2 Inappropriate Use

Any use MSK of motors outside of the fields of application mentioned above or under operating conditions and technical data other than those specified in this documentation is considered as "non-intended use".

MSK motors may not be used if . . .

- They are subject to operating conditions which do not comply with the ambient conditions described above. For example, they must not be operated under water, under extreme temperature fluctuations or extreme maximum temperatures.
- the intended application is not explicitly released by Bosch Rexroth. Please make absolutely sure that the instructions given in the general safety notes are also complied with!

3 Safety Instructions for Electric Drives and Controls

3.1 Safety Instructions - General Information

3.1.1 Using the Safety Instructions and Passing them on to Others

Do not attempt to install or commission this device without first reading all documentation provided with the product. Read and understand these safety instructions and all user documentation prior to working with the device. If you do not have the user documentation for the device, contact your responsible Bosch Rexroth sales representative. Ask for these documents to be sent immediately to the person or persons responsible for the safe operation of the device.

If the device is resold, rented and/or passed on to others in any other form, these safety instructions must be delivered with the device in the official language of the user's country.



WARNING

Improper use of these devices, failure to follow the safety instructions in this document or tampering with the product, including disabling of safety devices, may result in material damage, bodily harm, electric shock or even death!

Observe the safety instructions!

3.1.2 How to Employ the Safety Instructions

Read these instructions before initial commissioning of the equipment in order to eliminate the risk of bodily harm and/or material damage. Follow these safety instructions at all times.

- Bosch Rexroth AG is not liable for damages resulting from failure to observe the warnings provided in this documentation.
- Read the operating, maintenance and safety instructions in your language before commissioning the machine. If you find that you cannot completely understand the documentation for your product, please ask your supplier to clarify.
- Proper and correct transport, storage, assembly and installation, as well as care in operation and maintenance, are prerequisites for optimal and safe operation of this device.
- Only assign trained and qualified persons to work with electrical installations:
 - Only persons who are trained and qualified for the use and operation of the device may work on this device or within its proximity. The persons are qualified if they have sufficient knowledge of the assembly, installation and operation of the product, as well as an understanding of all warnings and precautionary measures noted in these instructions.
 - Furthermore, they must be trained, instructed and qualified to switch electrical circuits and devices on and off in accordance with technical safety regulations, to ground them and to mark them according to the requirements of safe work practices. They must have adequate safety equipment and be trained in first aid.
- Only use spare parts and accessories approved by the manufacturer.

Safety Instructions for Electric Drives and Controls

- Follow all safety regulations and requirements for the specific application as practiced in the country of use.
- The devices have been designed for installation in industrial machinery.
- The ambient conditions given in the product documentation must be observed.
- Only use safety-relevant applications that are clearly and explicitly approved in the Project Planning Manual. If this is not the case, they are excluded. Safety-relevant are all such applications which can cause danger to persons and material damage.
- The information given in the documentation of the product with regard to the use of the delivered components contains only examples of applications and suggestions.

The machine and installation manufacturer must

- make sure that the delivered components are suited for his individual application and check the information given in this documentation with regard to the use of the components,
- make sure that his application complies with the applicable safety regulations and standards and carry out the required measures, modifications and complements.
- Commissioning of the delivered components is only permitted once it is sure that the machine or installation in which they are installed complies with the national regulations, safety specifications and standards of the application.
- Operation is only permitted if the national EMC regulations for the application are met.
- The instructions for installation in accordance with EMC requirements can be found in the section on EMC in the respective documentation (Project Planning Manuals of components and system).
The machine or installation manufacturer is responsible for compliance with the limiting values as prescribed in the national regulations.
- Technical data, connection and installation conditions are specified in the product documentation and must be followed at all times.

National regulations which the user must take into account

- European countries: according to European EN standards
- United States of America (USA):
 - National Electrical Code (NEC)
 - National Electrical Manufacturers Association (NEMA), as well as local engineering regulations
 - regulations of the National Fire Protection Association (NFPA)
- Canada: Canadian Standards Association (CSA)
- Other countries:
 - International Organization for Standardization (ISO)
 - International Electrotechnical Commission (IEC)

3.1.3 Explanation of Warning Symbols and Degrees of Hazard Seriousness

The safety instructions describe the following degrees of hazard seriousness. The degree of hazard seriousness informs about the consequences resulting from non-compliance with the safety instructions:

Safety Instructions for Electric Drives and Controls



Warning symbol	Signal word	Degree of hazard seriousness acc. to ANSI Z 535.4-2002
	Danger	Death or severe bodily harm will occur.
	Warning	Death or severe bodily harm may occur.
	Caution	Minor or moderate bodily harm or material damage may occur.

Fig.3-1: Hazard classification (according to ANSI Z 535)

3.1.4 Hazards by Improper Use

**DANGER****High electric voltage and high working current! Risk of death or severe bodily injury by electric shock!**

Observe the safety instructions!

**DANGER****Dangerous movements! Danger to life, severe bodily harm or material damage by unintentional motor movements!**

Observe the safety instructions!

**WARNING****High electric voltage because of incorrect connection! Risk of death or bodily injury by electric shock!**

Observe the safety instructions!

**WARNING****Health hazard for persons with heart pacemakers, metal implants and hearing aids in proximity to electrical equipment!**

Observe the safety instructions!

**CAUTION****Hot surfaces on device housing! Danger of injury! Danger of burns!**

Observe the safety instructions!

**CAUTION****Risk of injury by improper handling! Risk of bodily injury by bruising, shearing, cutting, hitting or improper handling of pressurized lines!**

Observe the safety instructions!



CAUTION

Risk of injury by improper handling of batteries!

Observe the safety instructions!

3.2 Instructions with Regard to Specific Dangers

3.2.1 Protection Against Contact with Electrical Parts and Housings



This section concerns devices and drive components with voltages of **more than 50 Volt**.

Contact with parts conducting voltages above 50 Volts can cause personal danger and electric shock. When operating electrical equipment, it is unavoidable that some parts of the devices conduct dangerous voltage.



DANGER

High electrical voltage! Danger to life, electric shock and severe bodily injury!

- Only those trained and qualified to work with or on electrical equipment are permitted to operate, maintain and repair this equipment.
 - Follow general construction and safety regulations when working on power installations.
 - Before switching on the device, the equipment grounding conductor must have been non-detachably connected to all electrical equipment in accordance with the connection diagram.
 - Do not operate electrical equipment at any time, even for brief measurements or tests, if the equipment grounding conductor is not permanently connected to the mounting points of the components provided for this purpose.
 - Before working with electrical parts with voltage potentials higher than 50 V, the device must be disconnected from the mains voltage or power supply unit. Provide a safeguard to prevent reconnection.
 - With electrical drive and filter components, observe the following:
Wait **30 minutes** after switching off power to allow capacitors to discharge before beginning to work. Measure the electric voltage on the capacitors before beginning to work to make sure that the equipment is safe to touch.
 - Never touch the electrical connection points of a component while power is turned on. Do not remove or plug in connectors when the component has been powered.
 - Install the covers and guards provided with the equipment properly before switching the device on. Before switching the equipment on, cover and safeguard live parts safely to prevent contact with those parts.
 - A residual-current-operated circuit-breaker or r.c.d. cannot be used for electric drives! Indirect contact must be prevented by other means, for example, by an overcurrent protective device according to the relevant standards.
 - Secure built-in devices from direct touching of electrical parts by providing an external housing, for example a control cabinet.
-

Safety Instructions for Electric Drives and Controls



For electrical drive and filter components with voltages of **more than 50 volts**, observe the following additional safety instructions.

**DANGER****High housing voltage and high leakage current! Risk of death or bodily injury by electric shock!**

- Before switching on, the housings of all electrical equipment and motors must be connected or grounded with the equipment grounding conductor to the grounding points. This is also applicable before short tests.
- The equipment grounding conductor of the electrical equipment and the devices must be non-detachably and permanently connected to the power supply unit at all times. The leakage current is greater than 3.5 mA.
- Over the total length, use copper wire of a cross section of a minimum of 10 mm² for this equipment grounding connection!
- Before commissioning, also in trial runs, always attach the equipment grounding conductor or connect to the ground wire. Otherwise, high voltages may occur at the housing causing electric shock.

3.2.2 Protection Against Electric Shock by Protective Extra-Low Voltage

Protective extra-low voltage is used to allow connecting devices with basic insulation to extra-low voltage circuits.

All connections and terminals with voltages between 5 and 50 volts at Rexroth products are PELV systems. ¹⁾ It is therefore allowed to connect devices equipped with basic insulation (such as programming devices, PCs, notebooks, display units) to these connections and terminals.

**WARNING****High electric voltage by incorrect connection! Risk of death or bodily injury by electric shock!**

If extra-low voltage circuits of devices containing voltages and circuits of more than 50 volts (e.g. the mains connection) are connected to Rexroth products, the connected extra-low voltage circuits must comply with the requirements for PELV. ²⁾

3.2.3 Protection Against Dangerous Movements

Dangerous movements can be caused by faulty control of connected motors. Some common examples are:

- improper or wrong wiring of cable connections
- incorrect operation of the equipment components
- wrong input of parameters before operation
- malfunction of sensors, encoders and monitoring devices
- defective components
- software or firmware errors

Dangerous movements can occur immediately after equipment is switched on or even after an unspecified time of trouble-free operation.

¹⁾ "Protective Extra-Low Voltage"

²⁾ "Protective Extra-Low Voltage"

Safety Instructions for Electric Drives and Controls

The monitoring in the drive components will normally be sufficient to avoid faulty operation in the connected drives. Regarding personal safety, especially the danger of bodily harm and material damage, this alone cannot be relied upon to ensure complete safety. Until the integrated monitoring functions become effective, it must be assumed in any case that faulty drive movements will occur. The extent of faulty drive movements depends upon the type of control and the state of operation.



Dangerous movements! Danger to life, risk of injury, severe bodily harm or material damage!

- Ensure personal safety by means of qualified and tested higher-level monitoring devices or measures integrated in the installation.

These measures have to be provided for by the user according to the specific conditions within the installation and a hazard and fault analysis. The safety regulations applicable for the installation have to be taken into consideration. Unintended machine motion or other malfunction is possible if safety devices are disabled, bypassed or not activated.

To avoid accidents, bodily harm and/or material damage:

- Keep free and clear of the machine's range of motion and moving parts. Possible measures to prevent people from accidentally entering the machine's range of motion:
 - use safety fences
 - use safety guards
 - use protective coverings
 - install light curtains or light barriers
- Fences and coverings must be strong enough to resist maximum possible momentum.
- Mount the emergency stop switch in the immediate reach of the operator. Verify that the emergency stop works before startup. Don't operate the device if the emergency stop is not working.
- Isolate the drive power connection by means of an emergency stop circuit or use a safety related starting lockout to prevent unintentional start.
- Make sure that the drives are brought to a safe standstill before accessing or entering the danger zone.
- Additionally secure vertical axes against falling or dropping after switching off the motor power by, for example:
 - mechanically securing the vertical axes,
 - adding an external braking/ arrester/ clamping mechanism or
 - ensuring sufficient equilibration of the vertical axes.
- The standard equipment motor brake or an external brake controlled directly by the drive controller are **not sufficient to guarantee personal safety!**
- Disconnect electrical power to the equipment using a master switch and secure the switch against reconnection for:
 - maintenance and repair work
 - cleaning of equipment
 - long periods of discontinued equipment use
- Prevent the operation of high-frequency, remote control and radio equipment near electronics circuits and supply leads. If the use of such devices cannot be avoided, verify the system and the installation for possible malfunctions in all possible positions of normal use before initial startup. If necessary, perform a special electromagnetic compatibility (EMC) test on the installation.

3.2.4 Protection Against Magnetic and Electromagnetic Fields During Operation and Mounting

Magnetic and electromagnetic fields generated by current-carrying conductors and permanent magnets in motors represent a serious personal danger to those with heart pacemakers, metal implants and hearing aids.



WARNING

Health hazard for persons with heart pacemakers, metal implants and hearing aids in proximity to electrical equipment!

- Persons with heart pacemakers and metal implants are not permitted to enter following areas:
 - Areas in which electrical equipment and parts are mounted, being operated or commissioned.
 - Areas in which parts of motors with permanent magnets are being stored, repaired or mounted.
- If it is necessary for somebody with a pacemaker to enter such an area, a doctor must be consulted prior to doing so. The noise immunity of present or future implanted heart pacemakers differs greatly so that no general rules can be given.
- Those with metal implants or metal pieces, as well as with hearing aids, must consult a doctor before they enter the areas described above. Otherwise health hazards may occur.

3.2.5 Protection Against Contact with Hot Parts



CAUTION

Hot surfaces at motor housings, on drive controllers or chokes! Danger of injury! Danger of burns!

- Do not touch surfaces of device housings and chokes in the proximity of heat sources! Danger of burns!
- Do not touch housing surfaces of motors! Danger of burns!
- According to the operating conditions, temperatures can be **higher than 60 °C, 140°F** during or after operation.
- Before accessing motors after having switched them off, let them cool down for a sufficiently long time. Cooling down can require **up to 140 minutes!** Roughly estimated, the time required for cooling down is five times the thermal time constant specified in the Technical Data.
- After switching drive controllers or chokes off, wait 15 minutes to allow them to cool down before touching them.
- Wear safety gloves or do not work at hot surfaces.
- For certain applications, the manufacturer of the end product, machine or installation, according to the respective safety regulations, has to take measures to avoid injuries caused by burns in the end application. These measures can be, for example: warnings, guards (shielding or barrier), technical documentation.

3.2.6 Protection During Handling and Mounting

In unfavorable conditions, handling and mounting certain parts and components in an improper way can cause injuries.

**Risk of injury by improper handling! Bodily injury by bruising, shearing, cutting, hitting!**

- Observe the general construction and safety regulations on handling and mounting.
- Use suitable devices for mounting and transport.
- Avoid jamming and bruising by appropriate measures.
- Always use suitable tools. Use special tools if specified.
- Use lifting equipment and tools in the correct manner.
- If necessary, use suitable protective equipment (for example safety goggles, safety shoes, safety gloves).
- Do not stand under hanging loads.
- Immediately clean up any spilled liquids because of the danger of skidding.

3.2.7 Battery Safety

Batteries consist of active chemicals enclosed in a solid housing. Therefore, improper handling can cause injury or material damage.

**Risk of injury by improper handling!**

- Do not attempt to reactivate low batteries by heating or other methods (risk of explosion and cauterization).
- Do not recharge the batteries as this may cause leakage or explosion.
- Do not throw batteries into open flames.
- Do not dismantle batteries.
- When replacing the battery/batteries do not damage electrical parts installed in the devices.
- Only use the battery types specified by the manufacturer.



Environmental protection and disposal! The batteries contained in the product are considered dangerous goods during land, air, and sea transport (risk of explosion) in the sense of the legal regulations. Dispose of used batteries separate from other waste. Observe the local regulations in the country of assembly.

3.2.8 Protection Against Pressurized Systems

According to the information given in the Project Planning Manuals, motors cooled with liquid and compressed air, as well as drive controllers, can be partially supplied with externally fed, pressurized media, such as compressed air, hydraulics oil, cooling liquids and cooling lubricating agents. Improper handling of the connected supply systems, supply lines or connections can cause injuries or material damage.

Safety Instructions for Electric Drives and Controls



Risk of injury by improper handling of pressurized lines!

- Do not attempt to disconnect, open or cut pressurized lines (risk of explosion).
 - Observe the respective manufacturer's operating instructions.
 - Before dismounting lines, relieve pressure and empty medium.
 - Use suitable protective equipment (for example safety goggles, safety shoes, safety gloves).
 - Immediately clean up any spilled liquids from the floor.
-



Environmental protection and disposal! The agents used to operate the product might not be economically friendly. Dispose of ecologically harmful agents separately from other waste. Observe the local regulations in the country of assembly.

4 Technical Data

4.1 Definition of Parameters

4.1.1 Parameters on the Data Sheet

Data sheet - Motor

Designation	Symbol	Unit	Description
UL Files (UL)			UL File number
Continuous torque at standstill 60 K	M_{0_60}	Nm	Continuous torque that can be applied to the motor output shaft at a speed of $n \geq 0.1$ Hz.
Continuous current at standstill 60 K	$I_{0_60(rms)}$	A	Phase current (crest value) of the motor M_{dN} required for the continuous torque at standstill at a speed of $n \geq 0.1$ Hz.
Continuous torque at standstill 100 K	M_{0_100}	Nm	Continuous torque that can be applied to the motor output shaft at a speed of $n \geq 0.1$ Hz.
Continuous current at standstill 100 K	$I_{0_100(rms)}$	A	Phase current (crest value) of the motor M_{0_100} required for the continuous torque at standstill at a speed of $n \geq 0.1$ Hz.
Continuous torque at standstill surface	M_{0_S}	Nm	Continuous torque that can be applied to the motor output shaft during operation with fan unit at a speed of $n \geq 0.1$ Hz.
Continuous standstill current surface	$I_{0_S(rms)}$	A	Phase current (crest value) of the motor M_{0_L} required for the continuous torque at standstill at a speed of $n \geq 0.1$ Hz.
Continuous torque at standstill, liquid	M_{0_L}	Nm	Continuous torque that can be applied to the motor output shaft during operation with liquid cooling at a speed of $n \geq 0.1$ Hz.
Continuous current at standstill, liquid	$I_{0_L(rms)}$	A	Phase current (crest value) of the motor M_{0_L} required for the continuous torque at standstill at a speed of $n \geq 0.1$ Hz.
Maximum torque	M_{max}	Nm	The maximum torque that can be output for approx. 400 ms at a maximum current of I_{max} (guaranteed value which may be up to 20% higher). The maximum torque that can be attained depends on the drive control device used. Only the specified maximum torque in the selection lists is binding.
Maximum current	$I_{max(rms)}$	A	Maximum, briefly permissible phase current of the motor winding without adverse affect on the permanent magnet circuit of the motor.
Torque constant at 20 °C ¹⁾	K_{M_N}	Nm/A	Ratio of the created torque to the motor phase current at a motor temperature of 20°C. Unit: (Nm/A). Applicable up to approx. $i = 2x I_{dN}$.
Voltage constant at 20 °C ²⁾	K_{EMK_1000}	V/min ⁻¹	Root-mean-square value of the induced motor voltage at a motor temperature of 20 °C and 1,000 revolutions per minute.
Winding resistance at 20 °C	R_{12}	ohms	Winding resistance measured between two winding ends in ohms (Ω).
Winding inductivity	L_{12}	mH	Inductivity measured between two phases in (mH).
Discharge capacity of the component	C_{dis}	nF	Discharge capacity
Number of pole pairs	p	-	Number of pole pairs

Technical Data

Designation	Symbol	Unit	Description
Moment of inertia of the rotor	J_{rot}	kg*m ²	Moment of inertia of the rotor without the optional holding brake. Unit = kgm ² .
Thermal time constant	T_{th}	min	<p>Time of the temperature increase to 63 % of the maximum temperature of the motor housing with the motor loaded with the permissible S1 continuous torque. The thermal time constant is defined by the cooling mode used.</p> <p>① : Chronological course of the motor housing temperature Θ_{max} : Highest temperature (motor housing) T_{th} : Thermal time constant</p>
Maximum speed	n_{max}	min ⁻¹	Maximum permissible speed of the motor. Limiting factors can have mechanical (centrifugal forces, bearing stress) or electrical (DC link voltage) causes.
Sound pressure level	L_p	dB(A)	Value of sound emission
Weight ³⁾	m	kg	28,3 (32,1)
Ambient temperature in operation	T_{amb}	°C	0 ... 40
Type of protection according to IEC 60529		-	IP65
Insulation class according to DIN EN 60034-1		-	Insulation class
Holding brake (optional)			
Holding torque	M_4	Nm	Transferable holding torque
Rated voltage (+/-10 %)	U_N	V	Input voltage of the holding brake
Rated current	I_N	A	Current input of the holding brake
Connection time	t_1	ms	Response delay during connection
Disconnection time	t_2	ms	Disconnection time
Moment of inertia of the brake	J_{Br}	kgm ²	Moment of inertia of the holding brake. Has to be added to the moment of inertia of the rotor.

1) 2) Manufacturing tolerance ±5 %
 3) (...) Values for motors with holding brake, sorted (holding brake 1, holding brake 2 ...)

Fig.4-1: MSK - Technical data (standard and liquid cooling)

Technical Data

4.1.2 60 K and 100 K Parameters

The speed-torque curves and technical data are specified for two different temperature models.

- 60 K temperature increase on the housing and
- 100 K temperature increase on the winding



When selecting the technical data, observe the temperatures specified! The appropriate parameters are marked with **100 K** and **60 K**, respectively.

Setup and Measurement of the 60 K Characteristic Curve

The motor data and characteristic curves for IndraDyn S motors are determined under the following conditions:

- Ambient temperature about 40 °C
- Setup isolated
- Permissible temperature increase on the housing $\Delta T = 60 \text{ K}$
- In case of motors with the optional holding brake, the data are always specified for motors **with** a holding brake.
- Motors with radial shaft sealing ring

Setup and Measurement of the 100 K Characteristic Curve

The motor data and characteristic curves for IndraDyn S motors are determined under the following conditions:

- Ambient temperature about 40 °C
- Structure **not** insulated (attachment to steel flange, $L \times W \times H = 450 \times 30 \times 350$ or $120 \times 40 \times 100$)
- Permissible temperature increase on the winding $\Delta T = 100 \text{ K}$
- In case of motors with the optional holding brake, the data are always specified for motors **with** a holding brake.
- Motors with radial shaft sealing ring



The machine accuracy can be negatively affected by an increased linear expansion during 100 K operation. We recommend using 60 K data for the planning of systems.

4.1.3 Operating Modes

IndraDyn S motors are documented according to the inspection criteria and measurement procedures of EN 60034-1. The specified characteristic curves correspond to operating mode S1 or S3.

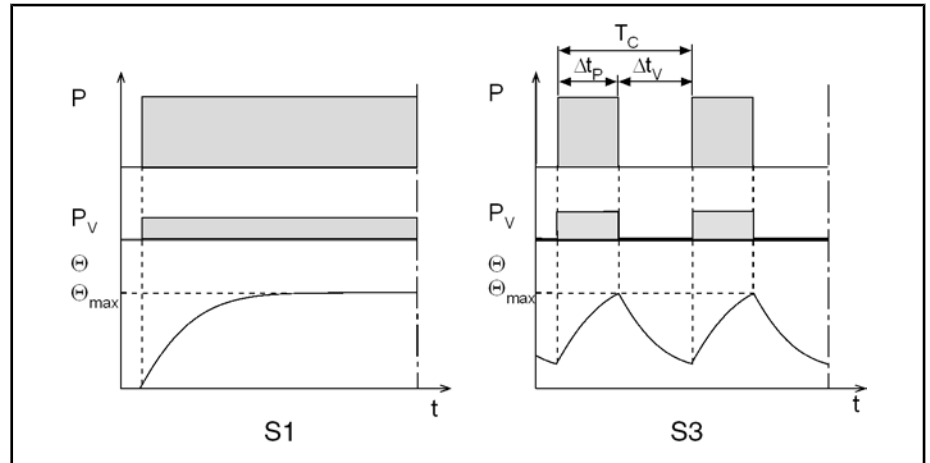

P	Load
P _V	Electric losses
Θ	Temperature
Θ _{max}	Highest temperature (motor housing)
t	Time
T _C	Cycle time
Δt _P	Operating time with constant load
Δt _V	Idling time

Fig.4-2: Operating modes according to EN 60034-1:1998

4.1.4 Duty Cycle

Operating mode S3 is supplemented by the specification of the duty cycle (DC) in %. The duty cycle is calculated as follows:

$$ED = \frac{\Delta t_P}{T_C} \cdot 100\%$$

DC	Relative duty cycle in %
Δt _P	Operating time with constant load

Fig.4-3: Relative duty cycle

The values specified in the documentation have been determined on the basis of the following parameters:

Cycle time: 10 min

Duty cycle (DC): 25 %

Technical Data

4.1.5 Example of a Characteristic Curve of a Motor

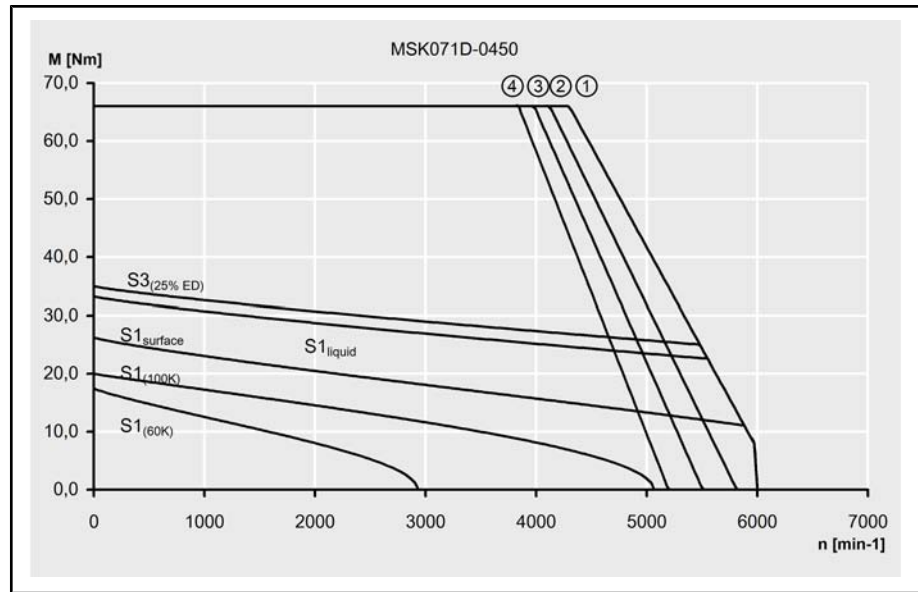

- S1 (60 K) Continuous operation curve S1 of the motor (according to EN 60034-1; 1998), natural convection
- S1 (100 K) Continuous operation curve S1 of the motor (according to EN 60034-1; 1998), natural convection
- S1 (surface) Continuous operation curve S1 of the motor (according to EN 60034-1; 1998), surface cooling.
- S3 (25 % DC) Intermittent operation curve at 25 % DC of the motor (according to EN 60034-1; 1998) and max. cycle time of 10 min.
- ① - ④ Characteristic voltage limit curves. When a speed at the safe commutation limit is reached, the voltage limit curve limits the available maximum torque Mmax. The maximum motor speed is determined by the DC link voltage used. There are separate characteristic curves for the various drive control devices in connection with the power supply unit and the supply voltage used.
- ① Mmax for IndraDrive, controlled feed, 3 × AC 400 V
- ② Mmax for IndraDrive, uncontrolled feed, 3 × AC 480 V
- ③ Mmax for IndraDrive, uncontrolled feed, 3 × AC 440 V
- ④ Mmax for IndraDrive, uncontrolled feed, 3 × AC 400 V

Fig.4-4: Example of a characteristic curve of a motor

4.2 MSK030B - Technical Data

Designation	Symbol	Unit	MSK030B-0900-NN
UL Files (UL)			E163211
Continuous torque at standstill 60 K	M_{0_60}	Nm	0.4
Continuous current at standstill 60 K	$I_{0_60(rms)}$	A	1.5
Continuous torque at standstill 100 K	M_{0_100}	Nm	0.4
Continuous current at standstill 100 K	$I_{0_100(rms)}$	A	1.7
Maximum torque	M_{max}	Nm	1.8
Maximum current	$I_{max(rms)}$	A	6.8
Torque constant at 20 °C ¹⁾	K_{M_N}	Nm/A	0.29
Voltage constant at 20 °C ²⁾	K_{EMK_1000}	V/min ⁻¹	17.9
Winding resistance at 20 °C	R_{12}	ohms	7.20
Winding inductivity	L_{12}	mH	8,100
Discharge capacity of the component	C_{dis}	nF	0.7
Number of pole pairs	p	-	3
Moment of inertia of the rotor	J_{rot}	kg*m ²	0.00001
Thermal time constant	T_{th}	min	19.0
Maximum speed	n_{max}	min ⁻¹	9,000
Sound pressure level	L_P	dB[A]	<75
Weight ³⁾	m	kg	1.3 (1.6)
Ambient temperature in operation	T_{amb}	°C	0 ... 40
Type of protection according to IEC 60529	---	-	IP65
Insulation class according to DIN EN 60034-1	---	-	155
Latest amendment: 2008-01-29			

1) 2)

Manufacturing tolerance ±5 %

3)

(...) Values for motors with holding brake, sorted (holding brake 1, holding brake 2 ...)

Fig.4-5:

Technical data

Designation	Symbol	Unit	Holding brake 1
Holding torque	M_4	Nm	1.0
Rated voltage	U_N	V	24
Latest amendment: 2002-02-28			

Technical Data

Designation	Symbol	Unit	Holding brake 1
Rated current	I_N	A	0.40
Connection time	t_1	ms	3
Disconnection time	t_2	ms	4
Moment of inertia of the holding brake	J_{rot}	kg*m ²	0.000007

Latest amendment: 2002-02-28

Fig.4-6: Holding brakes MSK030 - Technical data (optional)

Characteristic Motor Curves

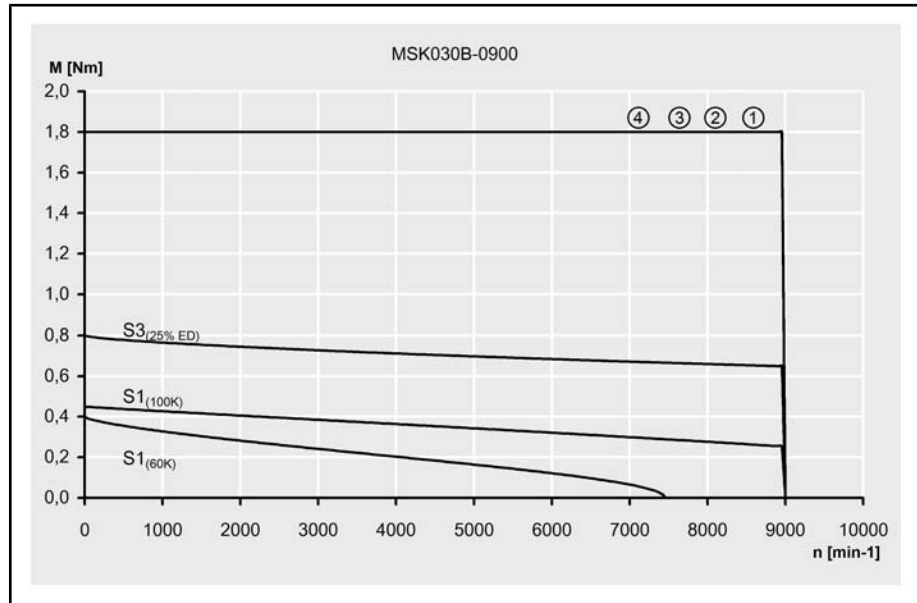

- ① Mmax for IndraDrive, controlled feed, 3 x AC 400 V
- ② Mmax for IndraDrive, uncontrolled feed, 3 x AC 480 V
- ③ Mmax for IndraDrive, uncontrolled feed, 3 x AC 440 V
- ④ Mmax for IndraDrive, uncontrolled feed, 3 x AC 400 V

Fig.4-7: Characteristic curves of a MSK030B-0900 motor

4.3 MSK030C - Technical Data

Designation	Symbol	Unit	MSK030C-0900-NN
UL Files (UL)			E163211
Continuous torque at standstill 60 K	M_{0_60}	Nm	0.8
Continuous current at standstill 60 K	$I_{0_60(rms)}$	A	1.5
Continuous torque at standstill 100 K	M_{0_100}	Nm	0.9
Continuous current at standstill 100 K	$I_{0_100(rms)}$	A	1.7
Maximum torque	M_{max}	Nm	4.0
Maximum current	$I_{max(rms)}$	A	6.8
Torque constant at 20 °C ¹⁾	K_{M_N}	Nm/A	0.58
Voltage constant at 20 °C ²⁾	K_{EMK_1000}	V/min ⁻¹	35.6
Winding resistance at 20 °C	R_{12}	ohms	9.80
Winding inductivity	L_{12}	mH	14.100
Discharge capacity of the component	C_{dis}	nF	1.3
Number of pole pairs	p	-	3
Moment of inertia of the rotor	J_{rot}	kg*m ²	0.00003
Thermal time constant	T_{th}	min	15.0
Maximum speed	n_{max}	min ⁻¹	9,000
Sound pressure level	L_P	dB[A]	<75
Weight ³⁾	m	kg	1.9 (2.1)
Ambient temperature in operation	T_{amb}	°C	0 ... 40
Type of protection according to IEC 60529	---	-	IP65
Insulation class according to DIN EN 60034-1	---	-	155
Latest amendment: 2008-01-29			

1) 2)

Manufacturing tolerance ±5 %

3)

(...) Values for motors with holding brake, sorted (holding brake 1, holding brake 2 ...)

Fig.4-8:

Technical data

Designation	Symbol	Unit	Holding brake 1
Holding torque	M_4	Nm	1.0
Rated voltage	U_N	V	24
Latest amendment: 2002-02-28			

Technical Data

Designation	Symbol	Unit	Holding brake 1
Rated current	I_N	A	0.40
Connection time	t_1	ms	3
Disconnection time	t_2	ms	4
Moment of inertia of the holding brake	J_{rot}	kg*m ²	0.000007

Latest amendment: 2002-02-28

Fig.4-9: Holding brakes MSK030 - Technical data (optional)

Characteristic Motor Curves

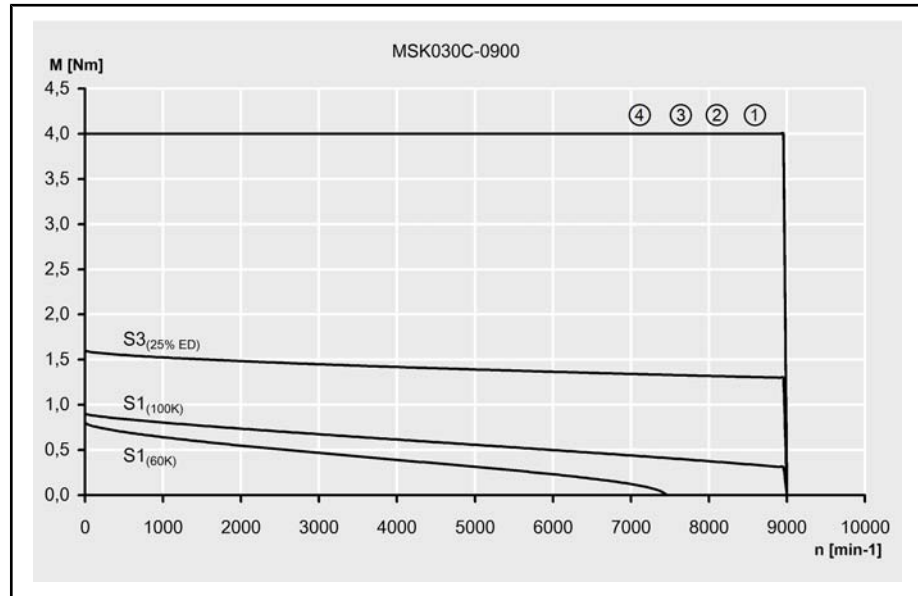

- ① Mmax for IndraDrive, controlled feed, 3 x AC 400 V
- ② Mmax for IndraDrive, uncontrolled feed, 3 x AC 480 V
- ③ Mmax for IndraDrive, uncontrolled feed, 3 x AC 440 V
- ④ Mmax for IndraDrive, uncontrolled feed, 3 x AC 400 V

Fig.4-10: Characteristic curves of a MSK030C-0900 motor

4.4 MSK040B - Technical Data

Designation	Symbol	Unit	MSK040B-0450-NN	MSK040B-0600-NN
UL Files (UL)			E163211	
Continuous torque at standstill 60 K	$M_{0,60}$	Nm	1.7	
Continuous current at standstill 60 K	$I_{0,60(rms)}$	A	1.5	2.0
Continuous torque at standstill 100 K	$M_{0,100}$	Nm	1.9	
Continuous current at standstill 100 K	$I_{0,100(rms)}$	A	1.7	2.2
Maximum torque	M_{max}	Nm	5.1	
Maximum current	$I_{max(rms)}$	A	6.0	8.0
Torque constant at 20 °C ¹⁾	$K_{M,N}$	Nm/A	1.26	0.92
Voltage constant at 20 °C ²⁾	$K_{EMK,1000}$	V/min ⁻¹	77.8	58.5
Winding resistance at 20 °C	R_{12}	ohms	14.70	8.40
Winding inductivity	L_{12}	mH	64.700	35.400
Discharge capacity of the component	C_{dis}	nF	1.3	1.5
Number of pole pairs	p	-	4	
Moment of inertia of the rotor	J_{rot}	kg*m ²	0.00010	
Thermal time constant	T_{th}	min	13.0	
Maximum speed	n_{max}	min ⁻¹	6,000	7,500
Sound pressure level	L_P	dB[A]	<75	
Weight ³⁾	m	kg	2.8 (3.1)	
Ambient temperature in operation	T_{amb}	°C	0 ... 40	
Type of protection according to IEC 60529	---	-	IP65	
Insulation class according to DIN EN 60034-1	---	-	155	
Latest amendment: 2008-04-30				

1) 2) Manufacturing tolerance $\pm 5\%$

3) (...) Values for motors with holding brake, sorted (holding brake 1, holding brake 2 ...)

Fig.4-11: MSK - Technical data (standard cooling)

Designation	Symbol	Unit	Holding brake 1
Holding torque	M_4	Nm	4.0
Rated voltage	U_N	V	24
Latest amendment: 2006-07-21			

Technical Data

Designation	Symbol	Unit	Holding brake 1
Rated current	I_N	A	0.50
Connection time	t_1	ms	25
Disconnection time	t_2	ms	35
Moment of inertia of the holding brake	J_{rot}	kg*m ²	0.000023

Latest amendment: 2006-07-21

Fig.4-12: Holding brakes MSK040 - Technical data (optional)

Characteristic Motor Curves

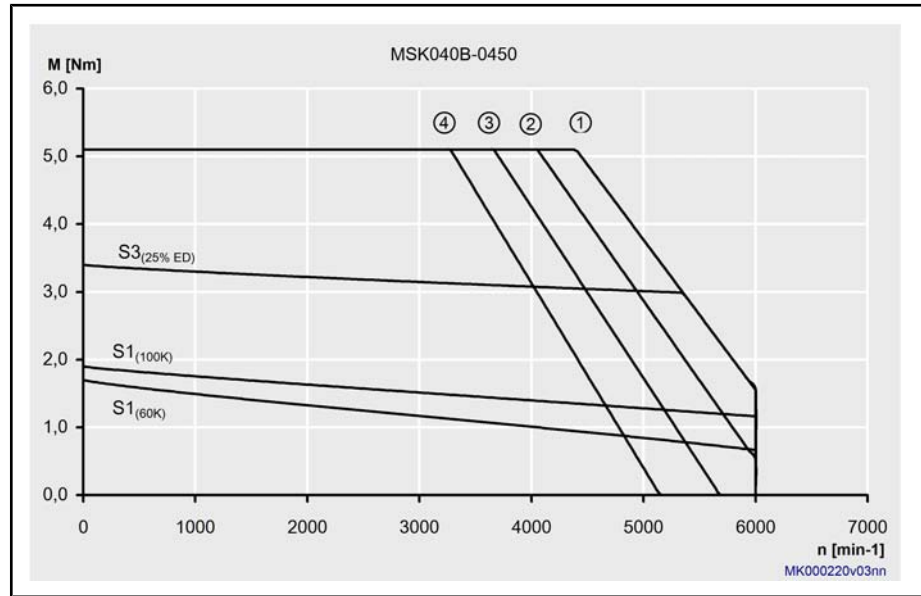

- ① Mmax for IndraDrive, controlled feed, 3 x AC 400 V
- ② Mmax for IndraDrive, uncontrolled feed, 3 x AC 480 V
- ③ Mmax for IndraDrive, uncontrolled feed, 3 x AC 440 V
- ④ Mmax for IndraDrive, uncontrolled feed, 3 x AC 400 V

Fig.4-13: Characteristic curves of a MSK040B-0450 motor

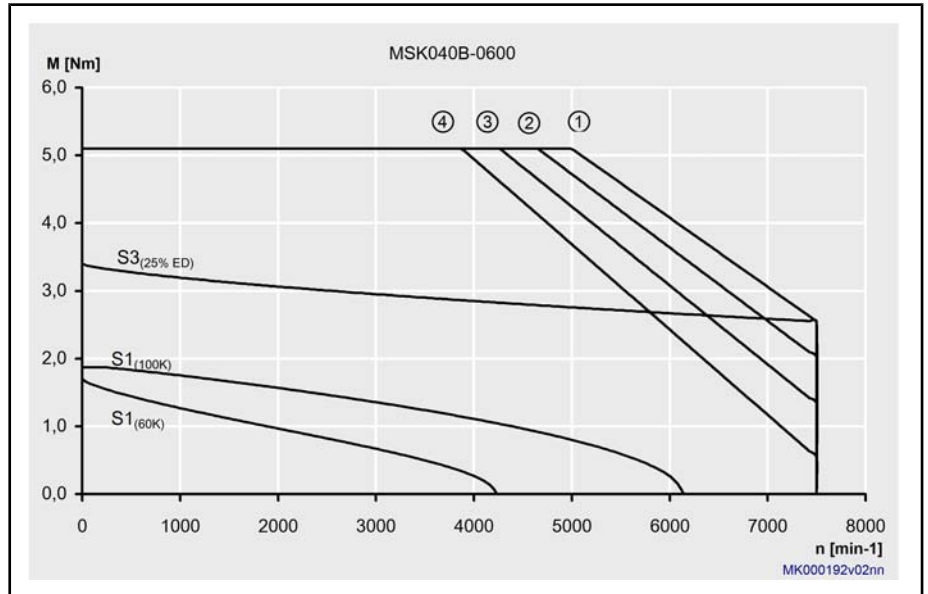

- ① Mmax for IndraDrive, controlled feed, 3 x AC 400 V
- ② Mmax for IndraDrive, uncontrolled feed, 3 x AC 480 V
- ③ Mmax for IndraDrive, uncontrolled feed, 3 x AC 440 V
- ④ Mmax for IndraDrive, uncontrolled feed, 3 x AC 400 V

Fig.4-14: Characteristic curves of a MSK040B-0600 motor

Technical Data

4.5 MSK040C - Technical Data

Designation	Symbol	Unit	MSK040C-0450-NN	MSK040C-0600-NN
UL Files (UL)			E163211	
Continuous torque at standstill 60 K	M_{0_60}	Nm	2.7	
Continuous current at standstill 60 K	$I_{0_60(rms)}$	A	2.4	3.1
Continuous torque at standstill 100 K	M_{0_100}	Nm	3.1	
Continuous current at standstill 100 K	$I_{0_100(rms)}$	A	3.1	4.7
Maximum torque	M_{max}	Nm	8.1	
Maximum current	$I_{max(rms)}$	A	9.6	12.4
Torque constant at 20 °C ¹⁾	K_{M_N}	Nm/A	1.25	0.95
Voltage constant at 20 °C ²⁾	K_{EMK_1000}	V/min ⁻¹	76.7	58.2
Winding resistance at 20 °C	R_{12}	ohms	7.40	3.90
Winding inductivity	L_{12}	mH	37.900	21.300
Discharge capacity of the component	C_{dis}	nF	2.0	
Number of pole pairs	p	-	4	
Moment of inertia of the rotor	J_{rot}	kg*m ²	0.00014	
Thermal time constant	T_{th}	min	16.0	
Maximum speed	n_{max}	min ⁻¹	6,000	7,500
Sound pressure level	L_P	dB[A]	<75	
Weight ³⁾	m	kg	3.6 (3.9)	
Ambient temperature in operation	T_{amb}	°C	0 ... 40	
Type of protection according to IEC 60529	---	-	IP65	
Insulation class according to DIN EN 60034-1	---	-	155	

Latest amendment: 2008-03-06

1) 2) Manufacturing tolerance ±5 %
 3) (...) Values for motors with holding brake, sorted (holding brake 1, holding brake 2 ...)

Fig.4-15: MSK - Technical data (standard cooling)

Designation	Symbol	Unit	Holding brake 1
Holding torque	M_4	Nm	4.0
Rated voltage	U_N	V	24

Latest amendment: 2006-07-21

Designation	Symbol	Unit	Holding brake 1
Rated current	I_N	A	0.50
Connection time	t_1	ms	25
Disconnection time	t_2	ms	35
Moment of inertia of the holding brake	J_{rot}	kg*m ²	0.000023
Latest amendment: 2006-07-21			

Fig.4-16: Holding brakes MSK040 - Technical data (optional)

Characteristic Motor Curves

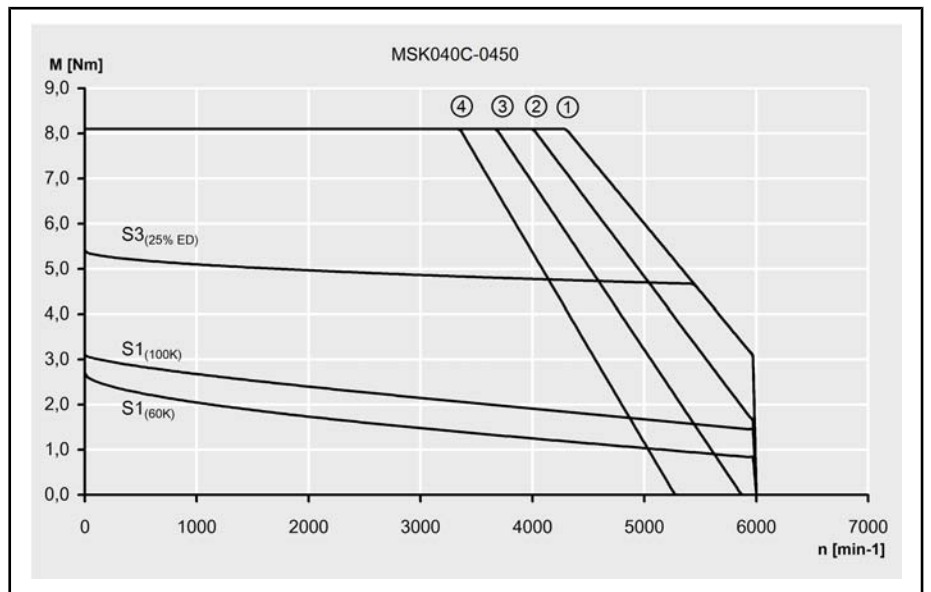

- ① Mmax for IndraDrive, controlled feed, 3 x AC 400 V
- ② Mmax for IndraDrive, uncontrolled feed, 3 x AC 480 V
- ③ Mmax for IndraDrive, uncontrolled feed, 3 x AC 440 V
- ④ Mmax for IndraDrive, uncontrolled feed, 3 x AC 400 V

Fig.4-17: Characteristic curves of a MSK040C-0450 motor

Technical Data

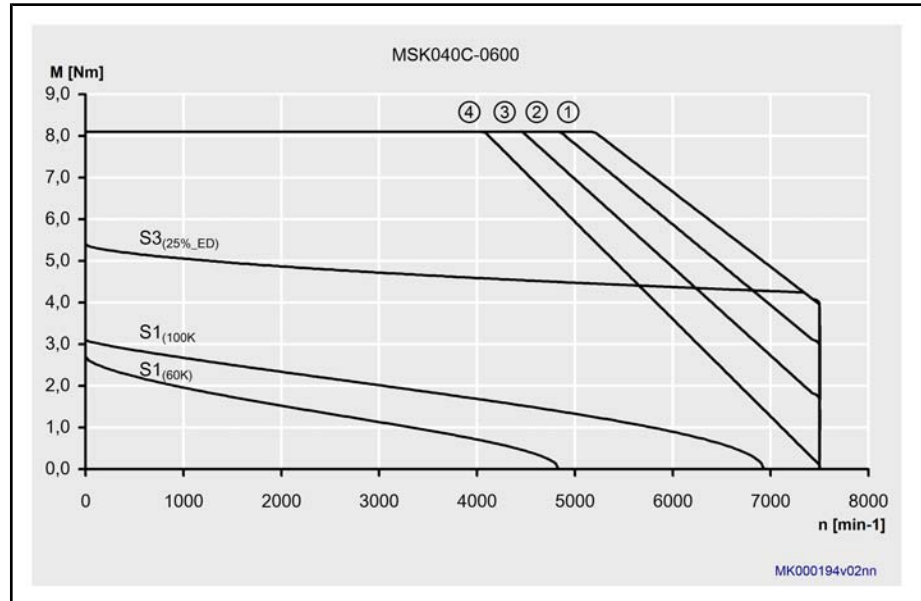

- ① Mmax for IndraDrive, controlled feed, 3 x AC 400 V
- ② Mmax for IndraDrive, uncontrolled feed, 3 x AC 480 V
- ③ Mmax for IndraDrive, uncontrolled feed, 3 x AC 440 V
- ④ Mmax for IndraDrive, uncontrolled feed, 3 x AC 400 V

Fig.4-18: Characteristic curves of a MSK040C-0600 motor

4.6 MSK050C - Technical Data

Designation	Symbol	Unit	MSK050B-0300-NN	MSK050B-0450-NN	MSK050B-0600-NN
UL Files (UL)			E163211		
Continuous torque at standstill 60 K	M_{0_60}	Nm	3.0		
Continuous current at standstill 60 K	$I_{0_60(rms)}$	A	1.8	2.8	3.7
Continuous torque at standstill 100 K	M_{0_100}	Nm	3.4		
Continuous current at standstill 100 K	$I_{0_100(rms)}$	A	2.0	3.2	4.2
Maximum torque	M_{max}	Nm	9.0		
Maximum current	$I_{max(rms)}$	A	7.2	11.2	14.8
Torque constant at 20 °C ¹⁾	K_{M_N}	Nm/A	1.80	1.20	0.90
Voltage constant at 20 °C ²⁾	K_{EMK_1000}	V/min ⁻¹	111.0	73.5	55.0
Winding resistance at 20 °C	R_{12}	ohms	13.10	5.70	3.30
Winding inductivity	L_{12}	mH	76.400	33.600	19.900
Discharge capacity of the component	C_{dis}	nF	2.1	1.4	2.1
Number of pole pairs	p	-	4		
Moment of inertia of the rotor	J_{rot}	kg*m ²	0.00028		
Thermal time constant	T_{th}	min	8.0		
Maximum speed	n_{max}	min ⁻¹	4,300	6,000	
Sound pressure level	L_P	dB[A]	<75		
Weight ³⁾	m	kg	4.0 (4.9)		
Ambient temperature in operation	T_{amb}	°C	0 ... 40		
Type of protection according to IEC 60529	---	-	IP65		
Insulation class according to DIN EN 60034-1	---	-	155		
Latest amendment: 2008-10-13					

1) 2)

Manufacturing tolerance ±5 %

3)

(...) Values for motors with holding brake, sorted (holding brake 1, holding brake 2 ...)

Fig.4-19:

Technical data

Designation	Symbol	Unit	Holding brake 1
Holding torque	M_4	Nm	5.0
Rated voltage	U_N	V	24
Latest amendment: 2004-04-08			

Technical Data

Designation	Symbol	Unit	Holding brake 1
Rated current	I_N	A	0.65
Connection time	t_1	ms	13
Disconnection time	t_2	ms	43
Moment of inertia of the holding brake	J_{rot}	kg*m ²	0.000107

Latest amendment: 2004-04-08

Fig.4-20: Holding brakes MSK050 - Technical data (optional)

Characteristic Motor Curves

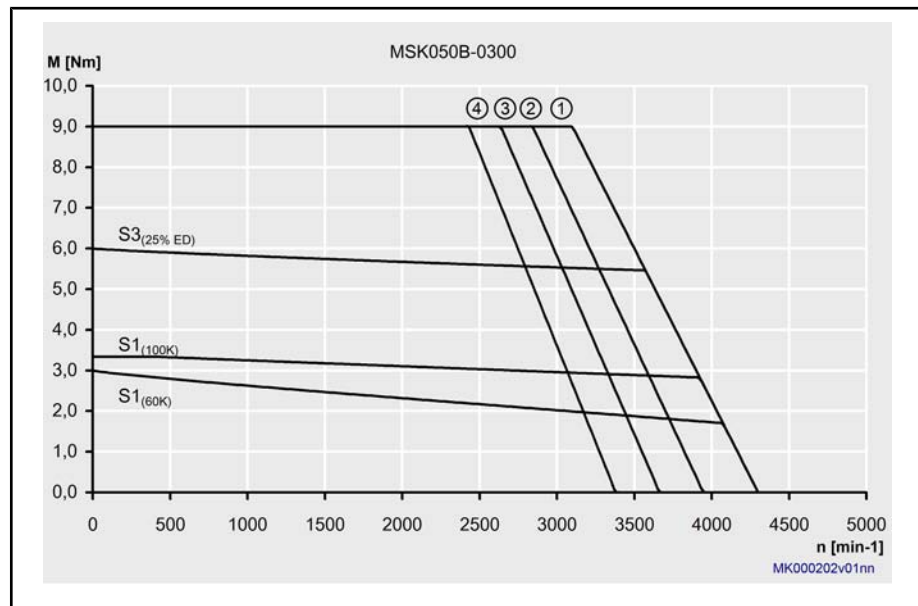

- ① Mmax for IndraDrive, controlled feed, 3 x AC 400 V
- ② Mmax for IndraDrive, uncontrolled feed, 3 x AC 480 V
- ③ Mmax for IndraDrive, uncontrolled feed, 3 x AC 440 V
- ④ Mmax for IndraDrive, uncontrolled feed, 3 x AC 400 V

Fig.4-21: Characteristic curves of a MSK050B-0300 motor

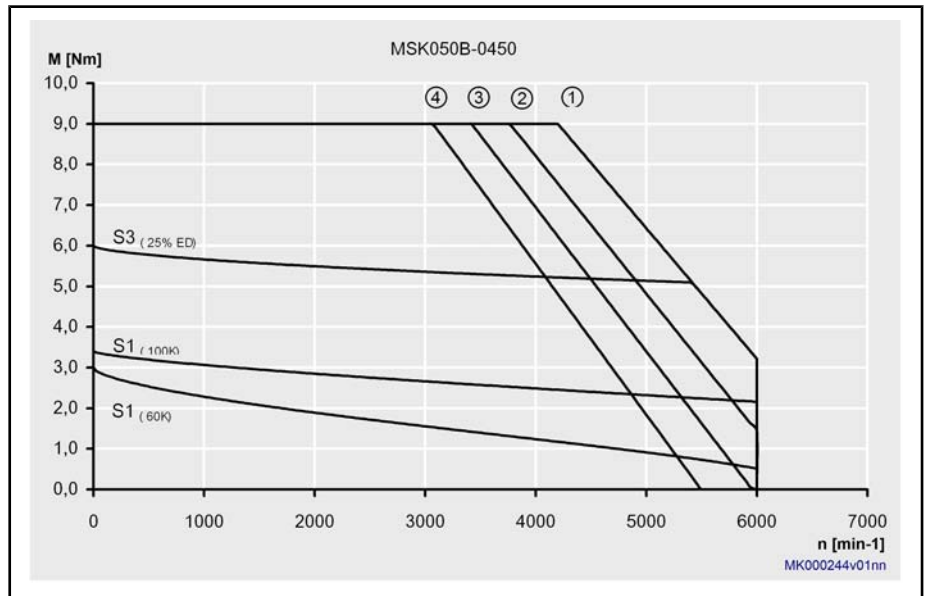

- ① Mmax for IndraDrive, controlled feed, 3 x AC 400 V
- ② Mmax for IndraDrive, uncontrolled feed, 3 x AC 480 V
- ③ Mmax for IndraDrive, uncontrolled feed, 3 x AC 440 V
- ④ Mmax for IndraDrive, uncontrolled feed, 3 x AC 400 V

Fig.4-22: Characteristic curves of a MSK050B-0450 motor

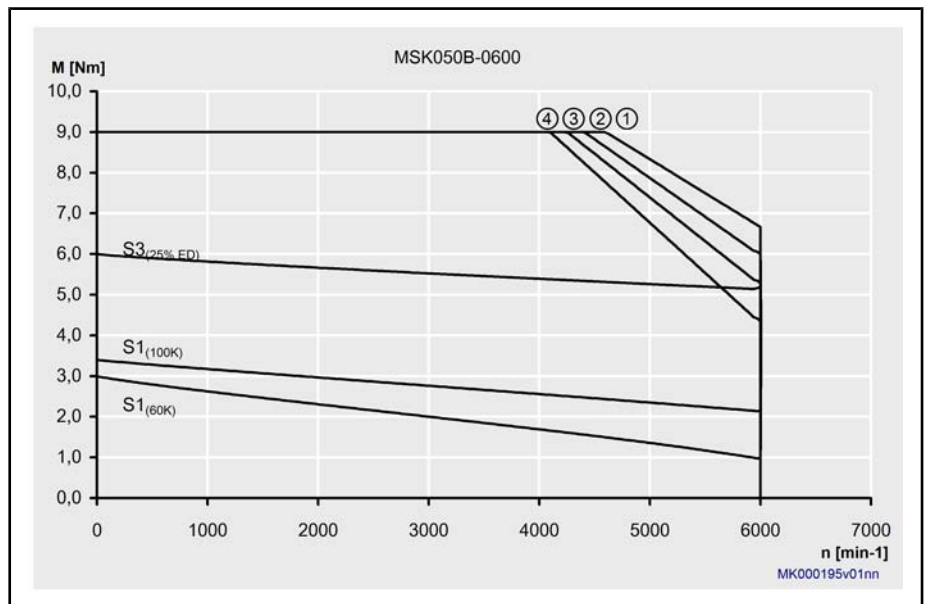

- ① Mmax for IndraDrive, controlled feed, 3 x AC 400 V
- ② Mmax for IndraDrive, uncontrolled feed, 3 x AC 480 V
- ③ Mmax for IndraDrive, uncontrolled feed, 3 x AC 440 V
- ④ Mmax for IndraDrive, uncontrolled feed, 3 x AC 400 V

Fig.4-23: Characteristic curves of a MSK050B-0600 motor

Technical Data

4.7 MSK050C - Technical Data

Designation	Symbol	Unit	MSK050C-0300-NN	MSK050C-0450-NN	MSK050C-0600-NN
UL Files (UL)			E163211		
Continuous torque at standstill 60 K	M_{0_60}	Nm	5.0		
Continuous current at standstill 60 K	$I_{0_60(rms)}$	A	3.1	4.7	6.2
Continuous torque at standstill 100 K	M_{0_100}	Nm	5.5		
Continuous current at standstill 100 K	$I_{0_100(rms)}$	A	3.4	5.2	6.8
Maximum torque	M_{max}	Nm	15.0		
Maximum current	$I_{max(rms)}$	A	12.4	18.8	24.8
Torque constant at 20 °C ¹⁾	K_{M_N}	Nm/A	1.77	1.16	0.89
Voltage constant at 20 °C ²⁾	K_{EMK_1000}	V/min ⁻¹	109.0	71.5	55.0
Winding resistance at 20 °C	R_{12}	ohms	6.60	3.20	1.70
Winding inductivity	L_{12}	mH	46.100	20.200	11.000
Discharge capacity of the component	C_{dis}	nF	2.6	2.4	2.6
Number of pole pairs	p	-	4		
Moment of inertia of the rotor	J_{rot}	kg*m ²	0.00033		
Thermal time constant	T_{th}	min	14.0		
Maximum speed	n_{max}	min ⁻¹	4,700	6,000	
Sound pressure level	L_P	dB[A]	<75		
Weight ³⁾	m	kg	5.4 (6.3)		
Ambient temperature in operation	T_{amb}	°C	0 ... 40		
Type of protection according to IEC 60529	---	-	IP65		
Insulation class according to DIN EN 60034-1	---	-	155		
Latest amendment: 2008-02-11					

1) 2) Manufacturing tolerance ±5 %
 3) (...) Values for motors with holding brake, sorted (holding brake 1, holding brake 2 ...)
Fig.4-24: Technical data

Designation	Symbol	Unit	Holding brake 1
Holding torque	M_4	Nm	5.0
Rated voltage	U_N	V	24
Latest amendment: 2004-04-08			

Designation	Symbol	Unit	Holding brake 1
Rated current	I_N	A	0.65
Connection time	t_1	ms	13
Disconnection time	t_2	ms	43
Moment of inertia of the holding brake	J_{rot}	kg*m ²	0.000107

Latest amendment: 2004-04-08

Fig.4-25: Holding brakes MSK050 - Technical data (optional)

Characteristic Motor Curves

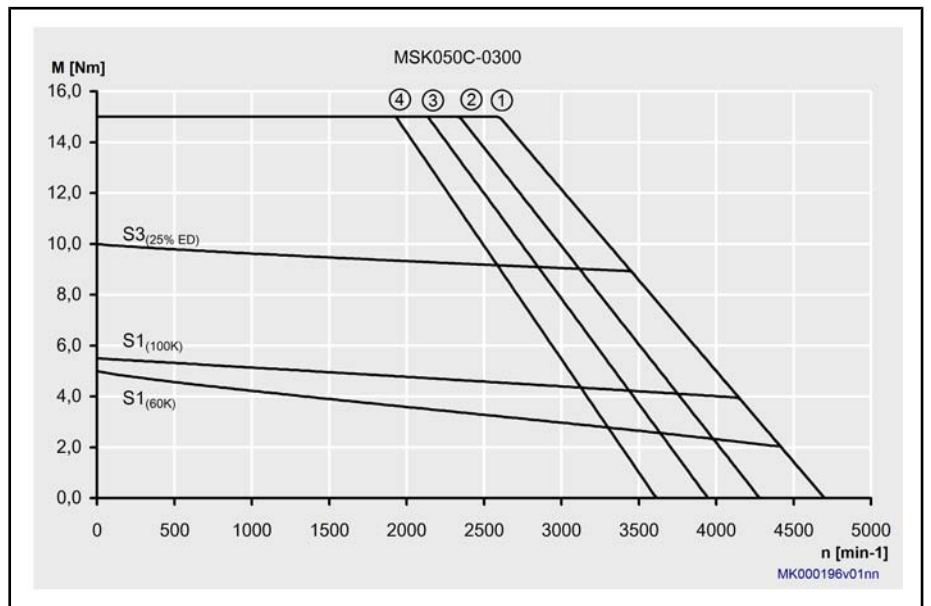

- ① Mmax for IndraDrive, controlled feed, 3 x AC 400 V
- ② Mmax for IndraDrive, uncontrolled feed, 3 x AC 480 V
- ③ Mmax for IndraDrive, uncontrolled feed, 3 x AC 440 V
- ④ Mmax for IndraDrive, uncontrolled feed, 3 x AC 400 V

Fig.4-26: Characteristic curves of a MSK050C-0300 motor

Technical Data

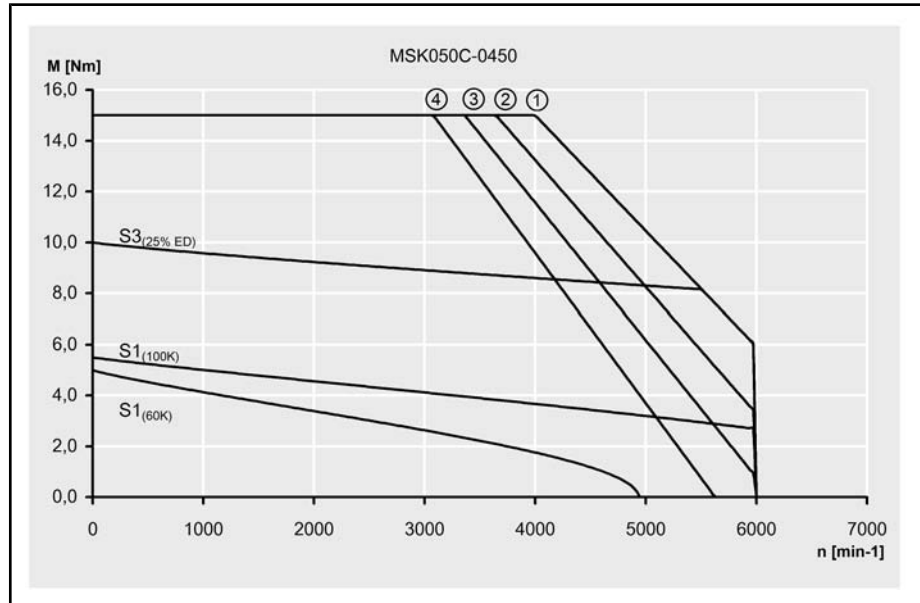

- ① Mmax for IndraDrive, controlled feed, 3 x AC 400 V
- ② Mmax for IndraDrive, uncontrolled feed, 3 x AC 480 V
- ③ Mmax for IndraDrive, uncontrolled feed, 3 x AC 440 V
- ④ Mmax for IndraDrive, uncontrolled feed, 3 x AC 400 V

Fig.4-27: Characteristic curves of a MSK050C-0450 motor

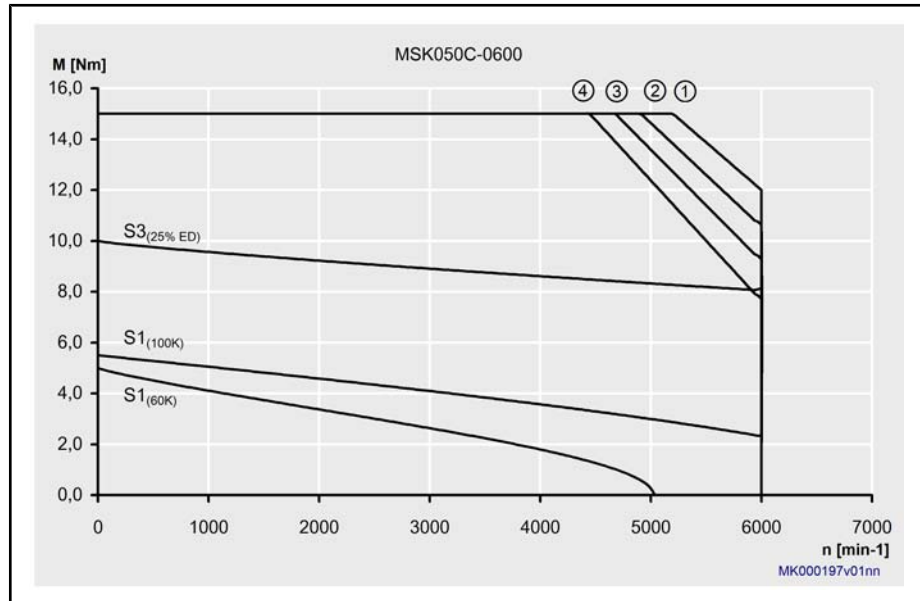

- ① Mmax for IndraDrive, controlled feed, 3 x AC 400 V
- ② Mmax for IndraDrive, uncontrolled feed, 3 x AC 480 V
- ③ Mmax for IndraDrive, uncontrolled feed, 3 x AC 440 V
- ④ Mmax for IndraDrive, uncontrolled feed, 3 x AC 400 V

Fig.4-28: Characteristic curves of a MSK050C-0600 motor

4.8 MSK060B - Technical Data

Designation	Symbol	Unit	MSK060B-0300-NN	MSK060B-0600-NN
UL Files (UL)			E163211	
Continuous torque at standstill 60 K	$M_{0,60}$	Nm	5.0	
Continuous current at standstill 60 K	$I_{0,60(rms)}$	A	3.0	6.1
Continuous torque at standstill 100 K	$M_{0,100}$	Nm	5.5	
Continuous current at standstill 100 K	$I_{0,100(rms)}$	A	3.3	6.7
Maximum torque	M_{max}	Nm	15.0	
Maximum Current	$I_{max(rms)}$	A	12.0	24.4
Torque constant at 20 °C ¹⁾	$K_{M,N}$	Nm/A	1.85	0.90
Voltage constant at 20 °C ²⁾	$K_{EMK,1000}$	V/min ⁻¹	113.5	55.2
Winding resistance at 20 °C	R_{12}	ohms	7.30	1.85
Winding inductivity	L_{12}	mH	73.000	18.000
Discharge capacity of the component	C_{dis}	nF	2.1	
Number of pole pairs	p	-	4	
Moment of inertia of the rotor	J_{rot}	kg*m ²	0.00048	
Thermal time constant	T_{th}	min	16.0	
Maximum speed	n_{max}	min ⁻¹	4,800	6,000
Sound pressure level	L_P	dB[A]	<75	
Weight ³⁾	m	kg	5.7 (6.4)	
Ambient temperature in operation	T_{amb}	°C	0 ... 40	
Type of protection according to IEC 60529	---	-	IP65	
Insulation class according to DIN EN 60034-1	---	-	155	
Latest amendment: 2008-02-11				

1) 2)

Manufacturing tolerance $\pm 5\%$

3)

(...) Values for motors with holding brake, sorted (holding brake 1, holding brake 2 ...)

Fig.4-29:

Technical data

Designation	Symbol	Unit	Holding brake 1
Holding torque	M_4	Nm	10.0
Rated voltage	U_N	V	24
Latest amendment: 2006-01-09			

Technical Data

Designation	Symbol	Unit	Holding brake 1
Rated current	I_N	A	0.75
Connection time	t_1	ms	25
Disconnection time	t_2	ms	40
Moment of inertia of the holding brake	J_{rot}	kg*m ²	0.000059

Latest amendment: 2006-01-09

Fig.4-30: Holding brakes MSK060 - Technical data (optional)

Characteristic Motor Curves

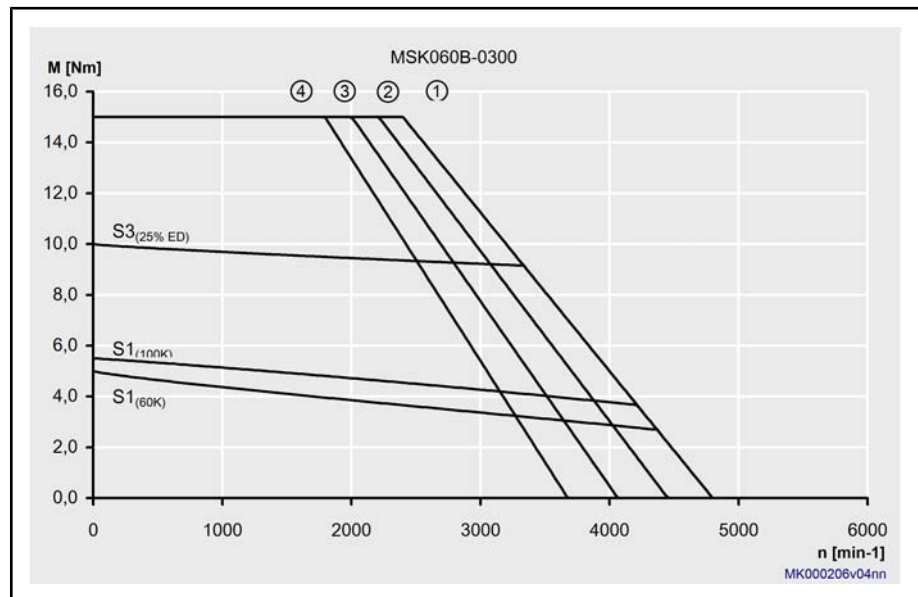

- ① Mmax for IndraDrive, controlled feed, 3 x AC 400 V
- ② Mmax for IndraDrive, uncontrolled feed, 3 x AC 480 V
- ③ Mmax for IndraDrive, uncontrolled feed, 3 x AC 440 V
- ④ Mmax for IndraDrive, uncontrolled feed, 3 x AC 400 V

Fig.4-31: Characteristic curves of a MSK060B-0300 motor

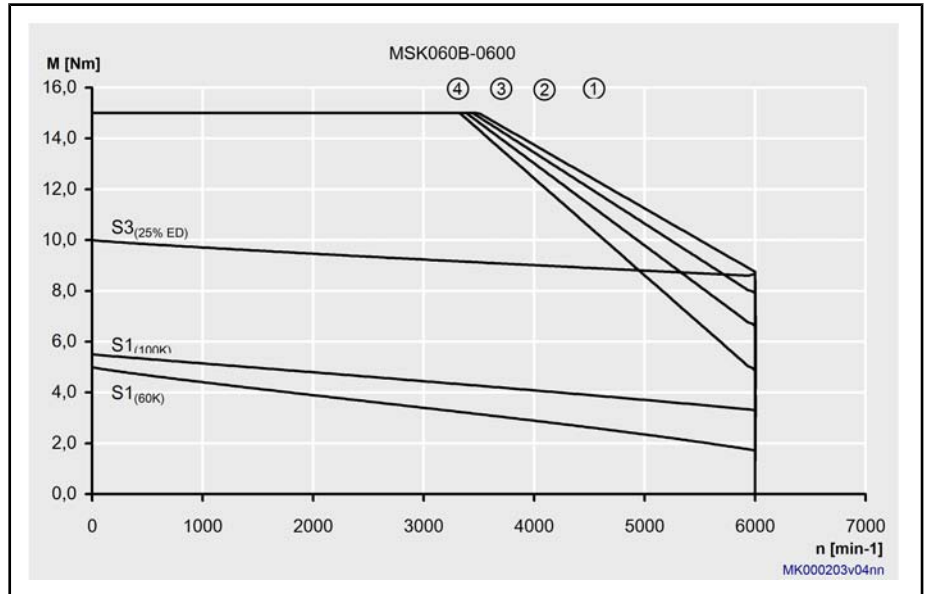

- ① Mmax for IndraDrive, controlled feed, 3 x AC 400 V
- ② Mmax for IndraDrive, uncontrolled feed, 3 x AC 480 V
- ③ Mmax for IndraDrive, uncontrolled feed, 3 x AC 440 V
- ④ Mmax for IndraDrive, uncontrolled feed, 3 x AC 400 V

Fig. 4-32: Characteristic curves of a MSK060B-0600 motor

Technical Data

4.9 MSK060C - Technical Data

Designation	Symbol	Unit	MSK060C-0300-NN	MSK060C-0600-NN
UL Files (UL)			E163211	
Continuous torque at standstill 60 K	$M_{0,60}$	Nm	8.0	
Continuous current at standstill 60 K	$I_{0,60(rms)}$	A	4.8	9.5
Continuous torque at standstill 100 K	$M_{0,100}$	Nm	8.8	
Continuous current at standstill 100 K	$I_{0,100(rms)}$	A	5.3	10.5
Continuous torque at standstill surface	$M_{0,S}$	Nm	12.0	
Continuous current at standstill surface	$I_{0,S(rms)}$	A	7.2	14.3
Maximum torque	M_{max}	Nm	24.0	
Maximum Current	$I_{max(rms)}$	A	19.2	38.0
Torque constant at 20 °C ¹⁾	$K_{M,N}$	Nm/A	1.85	0.93
Voltage constant at 20 °C ²⁾	$K_{EMK,1000}$	V/min ⁻¹	114.0	57.0
Winding resistance at 20 °C	R_{12}	ohms	3.10	0.80
Winding inductivity	L_{12}	mH	35.900	8.600
Discharge capacity of the component	C_{dis}	nF	2.1	2.2
Number of pole pairs	p	-	4	
Moment of inertia of the rotor	J_{rot}	kg*m ²	0.00080	
Thermal time constant	T_{th}	min	14.0	
Maximum speed	n_{max}	min ⁻¹	4,900	6,000
Sound pressure level	L_P	dB[A]	<75	
Weight ³⁾	m	kg	8.4 (9.2)	
Ambient temperature in operation	T_{amb}	°C	0 ... 40	
Type of protection according to IEC 60529	---	-	IP65	
Insulation class according to DIN EN 60034-1	---	-	155	

Latest amendment: 2008-02-11

1) 2)

Manufacturing tolerance $\pm 5\%$

3)

(...) Values for motors with holding brake, sorted (holding brake 1, holding brake 2 ...)

Fig.4-33:

Technical data

Designation	Symbol	Unit	Holding brake 1
Holding torque	M_4	Nm	10.0
Rated voltage	U_N	V	24
Rated current	I_N	A	0.75
Connection time	t_1	ms	25
Disconnection time	t_2	ms	40
Moment of inertia of the holding brake	J_{rot}	kg*m ²	0.000059

Latest amendment: 2006-01-09

Fig.4-34: Holding brakes MSK060 - Technical data (optional)

Characteristic Motor Curves

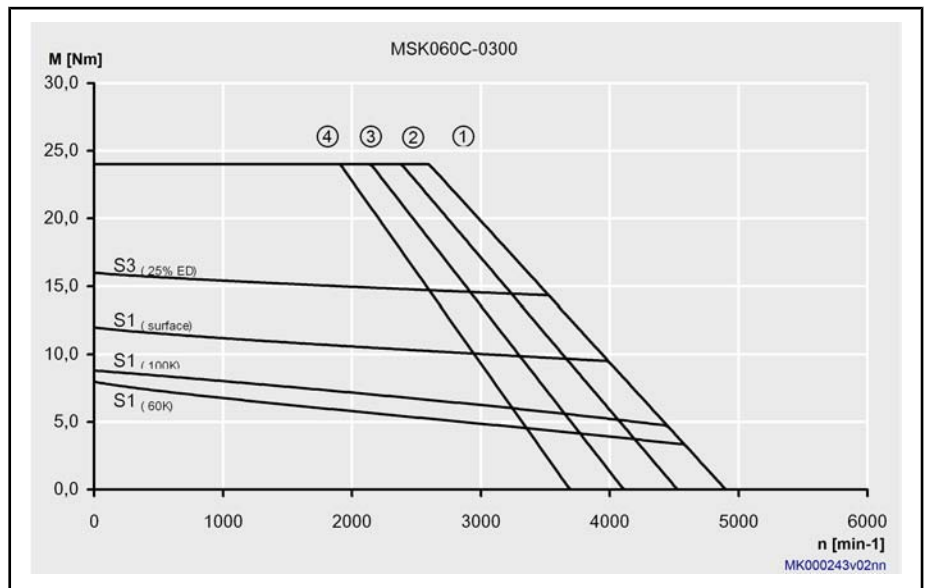

- ① Mmax for IndraDrive, controlled feed, 3 x AC 400 V
- ② Mmax for IndraDrive, uncontrolled feed, 3 x AC 480 V
- ③ Mmax for IndraDrive, uncontrolled feed, 3 x AC 440 V
- ④ Mmax for IndraDrive, uncontrolled feed, 3 x AC 400 V

Fig.4-35: Characteristic curves of a MSK060C-0300 motor

Technical Data

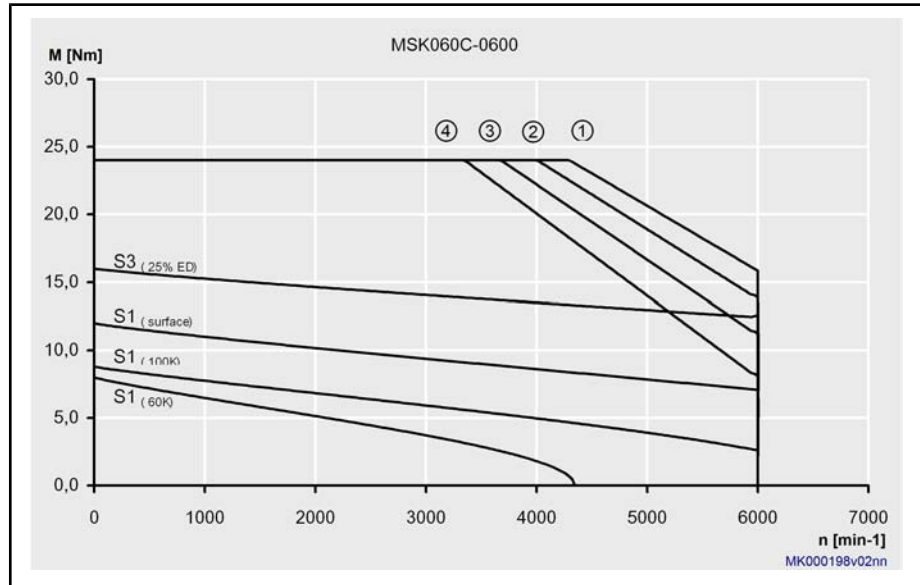

- ① Mmax for IndraDrive, controlled feed, 3 x AC 400 V
- ② Mmax for IndraDrive, uncontrolled feed, 3 x AC 480 V
- ③ Mmax for IndraDrive, uncontrolled feed, 3 x AC 440 V
- ④ Mmax for IndraDrive, uncontrolled feed, 3 x AC 400 V

Fig.4-36: Characteristic curves of a MSK060C-0600 motor

4.10 MSK061B - Technical Data

Designation	Symbol	Unit	MSK061B-0300-NN preliminary
UL Files (UL)			
Continuous torque at standstill 60 K	$M_{0,60}$	Nm	3.5
Continuous current at standstill 60 K	$I_{0,60(rms)}$	A	1.9
Continuous torque at standstill 100 K	$M_{0,100}$	Nm	3.9
Continuous current at standstill 100 K	$I_{0,100(rms)}$	A	2.1
Maximum torque	M_{max}	Nm	14.0
Maximum Current	$I_{max(rms)}$	A	8.6
Torque constant at 20 °C ¹⁾	$K_{M,N}$	Nm/A	2.05
Voltage constant at 20 °C ²⁾	$K_{EMK,1000}$	V/min ⁻¹	126.4
Winding resistance at 20 °C	R_{12}	ohms	13.50
Winding inductivity	L_{12}	mH	44.000
Discharge capacity of the component	C_{dis}	nF	1.8
Number of pole pairs	p	-	4
Moment of inertia of the rotor	J_{rot}	kg*m ²	0.00044
Thermal time constant	T_{th}	min	15.0
Maximum speed	n_{max}	min ⁻¹	4,200
Sound pressure level	L_P	dB[A]	<75
Weight ³⁾	m	kg	5.7 (6.4)
Ambient temperature in operation	T_{amb}	°C	0 ... 40
Type of protection according to IEC 60529	---	-	IP65
Insulation class according to DIN EN 60034-1	---	-	155
Latest amendment: 2008-10-02			

1) 2)

Manufacturing tolerance ±5 %

3)

(...) Values for motors with holding brake, sorted (holding brake 1, holding brake 2 ...)

Fig.4-37:

MSK - Technical data (standard cooling)

Technical Data

Designation	Symbol	Unit	Holding brake 1
Holding torque	M_4	Nm	10.0
Rated voltage	U_N	V	24
Rated current	I_N	A	0.75
Connection time	t_1	ms	25
Disconnection time	t_2	ms	40
Moment of inertia of the holding brake	J_{rot}	kg*m ²	0.000059

Latest amendment: 2006-01-09

Fig.4-38: Holding brakes MSK061 - Technical data (optional)

Characteristic Motor Curves

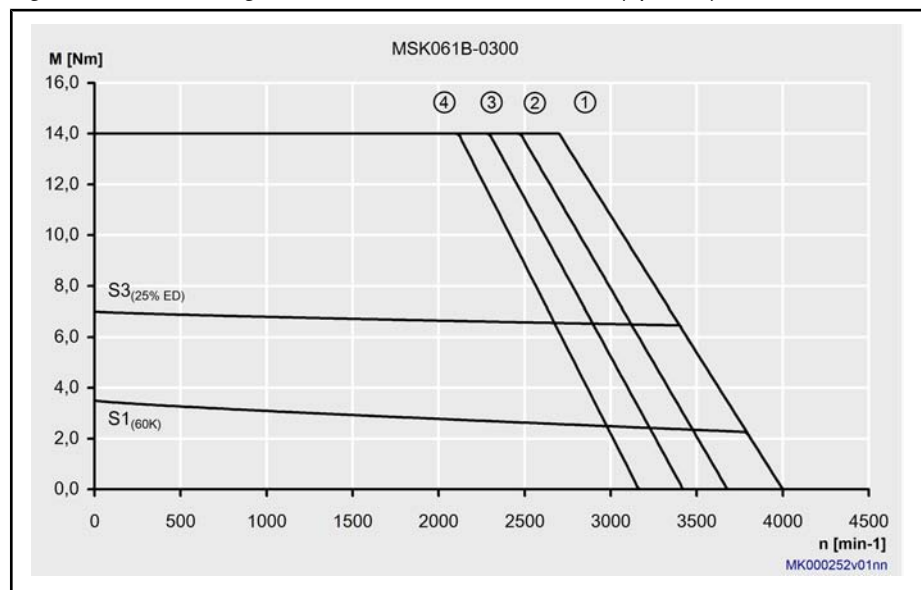

- ① Mmax for IndraDrive, controlled feed, 3 x AC 400 V
- ② Mmax for IndraDrive, uncontrolled feed, 3 x AC 480 V
- ③ Mmax for IndraDrive, uncontrolled feed, 3 x AC 440 V
- ④ Mmax for IndraDrive, uncontrolled feed, 3 x AC 400 V

Fig.4-39: Characteristic curves of a MSK061B-0300 motor

4.11 MSK061C - Technical Data

Designation	Symbol	Unit	MSK061C-0200-NN	MSK061C-0300-NN	MSK061C-0600-NN
UL Files (UL)			E163211		
Continuous torque at standstill 60 K	M_{0_60}	Nm	8.0		
Continuous current at standstill 60 K	$I_{0_60(rms)}$	A	3.2	4.3	7.7
Continuous torque at standstill 100 K	M_{0_100}	Nm	9.0		
Continuous current at standstill 100 K	$I_{0_100(rms)}$	A	3.6	4.8	8.7
Continuous torque at standstill surface	M_{0_S}	Nm	12.0		
Continuous current at standstill surface	$I_{0_S(rms)}$	A	4.8	6.5	11.6
Maximum torque	M_{max}	Nm	32.0		
Maximum Current	$I_{max(rms)}$	A	14.4	19.4	34.7
Torque constant at 20 °C ¹⁾	K_{M_N}	Nm/A	2.80	2.04	1.14
Voltage constant at 20 °C ²⁾	K_{EMK_1000}	V/min ⁻¹	174.9	125.7	70.5
Winding resistance at 20 °C	R_{12}	ohms	8.10	4.50	1.55
Winding inductivity	L_{12}	mH	36.500	21.400	6.700
Discharge capacity of the component	C_{dis}	nF	2.7	2.4	2.1
Number of pole pairs	p	-	4		
Moment of inertia of the rotor	J_{rot}	kg*m ²	0.00075		
Thermal time constant	T_{th}	min	18.0		15.0
Maximum speed	n_{max}	min ⁻¹	3,100	4,200	6,000
Sound pressure level	L_P	dB[A]	<75		
Weight ³⁾	m	kg	8.3 (8.8)		
Ambient temperature in operation	T_{amb}	°C	0 ... 40		
Type of protection according to IEC 60529	---	-	IP65		
Insulation class according to DIN EN 60034-1	---	-	155		

Latest amendment: 2008-05-29

1) 2)

Manufacturing tolerance ±5 %

3)

(...) Values for motors with holding brake, sorted (holding brake 1, holding brake 2 ...)

Fig.4-40:

MSK - Technical data (standard and air cooling)

Technical Data

Designation	Symbol	Unit	Holding brake 1
Holding torque	M_4	Nm	10.0
Rated voltage	U_N	V	24
Rated current	I_N	A	0.75
Connection time	t_1	ms	25
Disconnection time	t_2	ms	40
Moment of inertia of the holding brake	J_{rot}	kg*m ²	0.000059

Latest amendment: 2006-01-09

Fig.4-41: Holding brakes MSK061 - Technical data (optional)

Characteristic Motor Curves

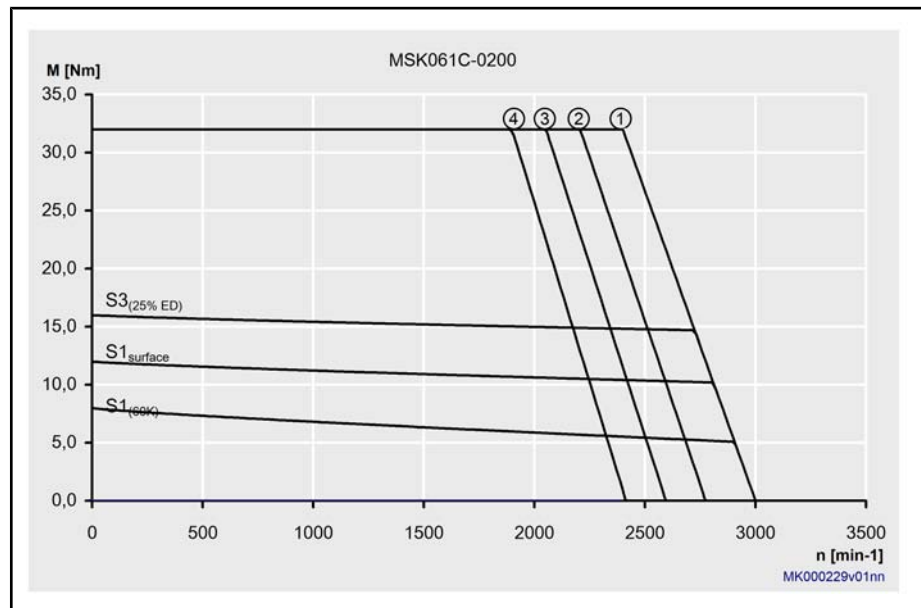

- ① Mmax for IndraDrive, controlled feed, 3 x AC 400 V
- ② Mmax for IndraDrive, uncontrolled feed, 3 x AC 480 V
- ③ Mmax for IndraDrive, uncontrolled feed, 3 x AC 440 V
- ④ Mmax for IndraDrive, uncontrolled feed, 3 x AC 400 V

Fig.4-42: Characteristic curves of a MSK061C-0200 motor

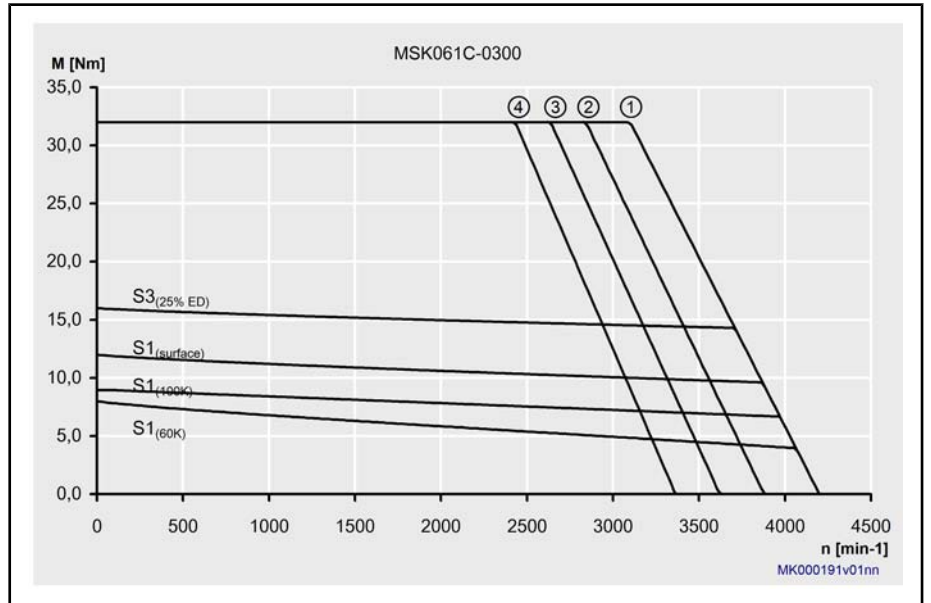

- ① Mmax for IndraDrive, controlled feed, 3 x AC 400 V
- ② Mmax for IndraDrive, uncontrolled feed, 3 x AC 480 V
- ③ Mmax for IndraDrive, uncontrolled feed, 3 x AC 440 V
- ④ Mmax for IndraDrive, uncontrolled feed, 3 x AC 400 V

Fig. 4-43: Characteristic curves of a MSK061C-0300 motor

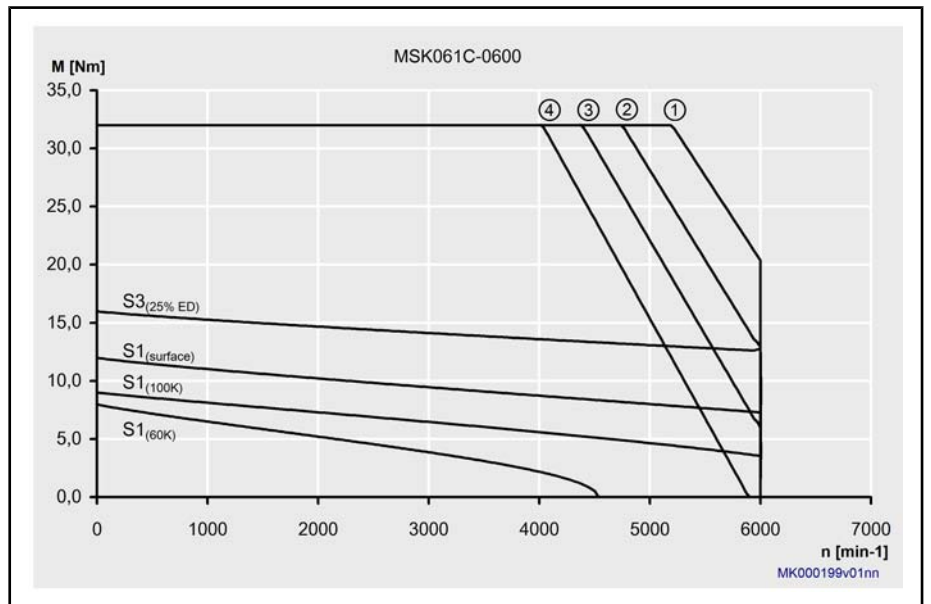

- ① Mmax for IndraDrive, controlled feed, 3 x AC 400 V
- ② Mmax for IndraDrive, uncontrolled feed, 3 x AC 480 V
- ③ Mmax for IndraDrive, uncontrolled feed, 3 x AC 440 V
- ④ Mmax for IndraDrive, uncontrolled feed, 3 x AC 400 V

Fig. 4-44: Characteristic curves of a MSK061C-0600 motor

Technical Data

4.12 MSK070C - Technical Data

Designation	Symbol	Unit	MSK070C-0150-NN	MSK070C-0300-NN	MSK070C-0450-NN
UL Files (UL)			E163211		
Continuous torque at standstill 60 K	M_{0_60}	Nm	13.0		
Continuous current at standstill 60 K	$I_{0_60(rms)}$	A	4.1	8.2	12.3
Continuous torque at standstill 100 K	M_{0_100}	Nm	14.5		
Continuous current at standstill 100 K	$I_{0_100(rms)}$	A	4.6	9.2	13.7
Continuous torque at standstill surface	M_{0_S}	Nm	19.5		
Continuous current at standstill surface	$I_{0_S(rms)}$	A	6.2	12.3	18.5
Maximum torque	M_{max}	Nm	33.0		
Maximum Current	$I_{max(rms)}$	A	16.4	32.8	36.9
Torque constant at 20 °C ¹⁾	$K_{M,N}$	Nm/A	3.47	1.74	1.16
Voltage constant at 20 °C ²⁾	K_{EMK_1000}	V/min ⁻¹	213.2	107.0	71.3
Winding resistance at 20 °C	R_{12}	ohms	4.70	1.13	0.55
Winding inductivity	L_{12}	mH	34.900	8.300	4.000
Discharge capacity of the component	C_{dis}	nF	3.8	4.0	3.1
Number of pole pairs	p	-	6		
Moment of inertia of the rotor	J_{rot}	kg*m ²	0.00291		
Thermal time constant	T_{th}	min	22.0		31.0
Maximum speed	n_{max}	min ⁻¹	2,500	5,500	6,000
Sound pressure level	L_P	dB[A]	<75		
Weight ³⁾	m	kg	11.7 (13.2)		
Ambient temperature in operation	T_{amb}	°C	0 ... 40		
Type of protection according to IEC 60529	---	-	IP65		
Insulation class according to DIN EN 60034-1	---	-	155		

Latest amendment: 2008-01-29

1) 2)

Manufacturing tolerance $\pm 5\%$

3)

(...) Values for motors with holding brake, sorted (holding brake 1, holding brake 2 ...)

Fig.4-45:

Technical data

Designation	Symbol	Unit	Holding brake 1
Holding torque	M_4	Nm	23.0
Rated voltage	U_N	V	24
Rated current	I_N	A	0.79
Connection time	t_1	ms	130
Disconnection time	t_2	ms	180
Moment of inertia of the holding brake	J_{rot}	kg*m ²	0.000300

Latest amendment: 2004-08-27

Fig.4-46: Holding brakes MSK070 - Technical data (optional)

Characteristic Motor Curves

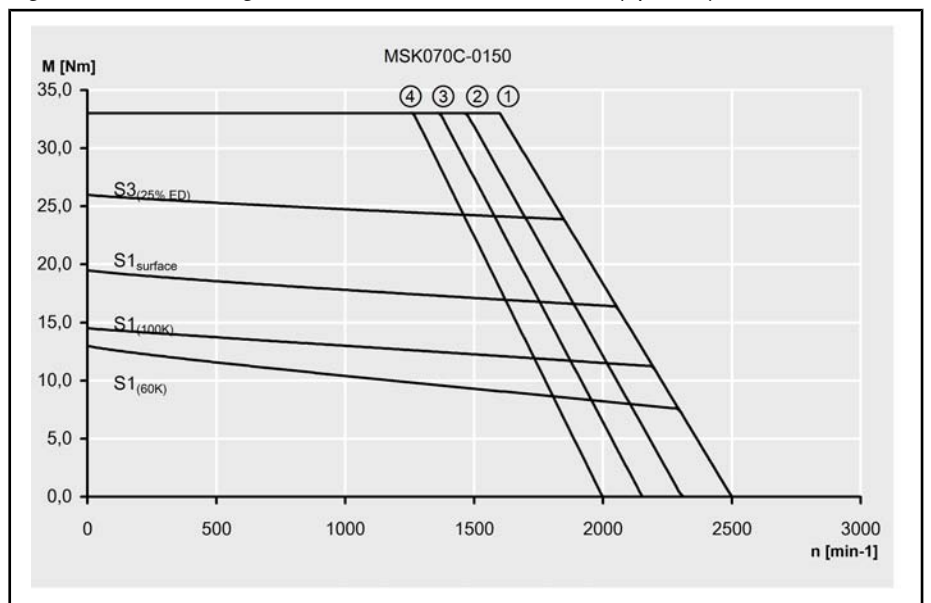

- ① Mmax for IndraDrive, controlled feed, 3 x AC 400 V
- ② Mmax for IndraDrive, uncontrolled feed, 3 x AC 480 V
- ③ Mmax for IndraDrive, uncontrolled feed, 3 x AC 440 V
- ④ Mmax for IndraDrive, uncontrolled feed, 3 x AC 400 V

Fig.4-47: Characteristic curves of a MSK070C-0150 motor

Technical Data

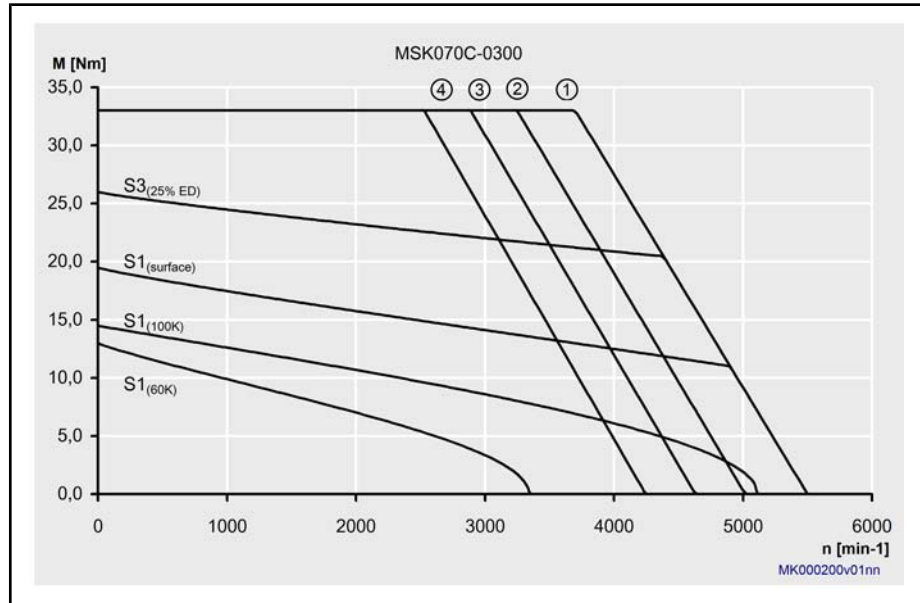

- ① Mmax for IndraDrive, controlled feed, 3 x AC 400 V
- ② Mmax for IndraDrive, uncontrolled feed, 3 x AC 480 V
- ③ Mmax for IndraDrive, uncontrolled feed, 3 x AC 440 V
- ④ Mmax for IndraDrive, uncontrolled feed, 3 x AC 400 V

Fig.4-48: Characteristic curves of a MSK070C-0300 motor

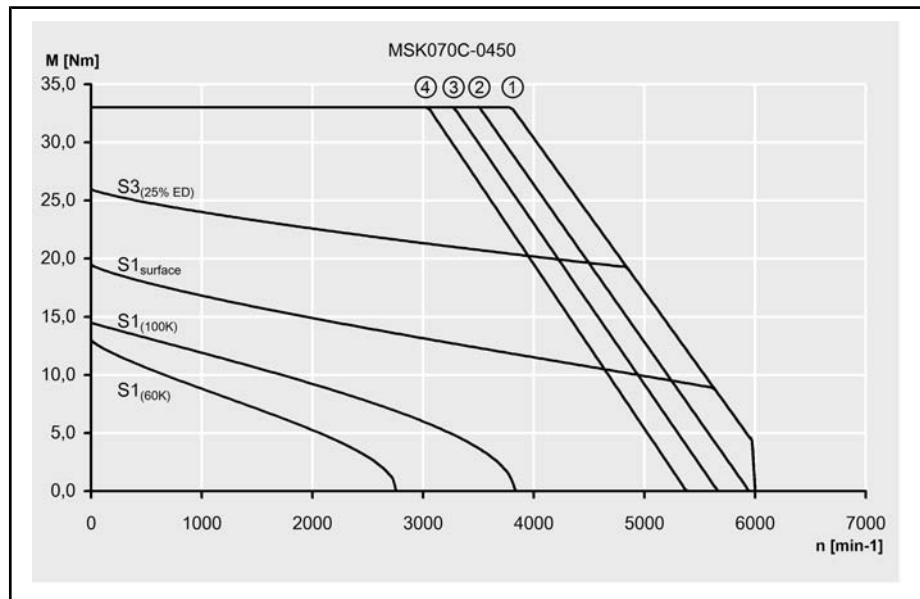

- ① Mmax for IndraDrive, controlled feed, 3 x AC 400 V
- ② Mmax for IndraDrive, uncontrolled feed, 3 x AC 480 V
- ③ Mmax for IndraDrive, uncontrolled feed, 3 x AC 440 V
- ④ Mmax for IndraDrive, uncontrolled feed, 3 x AC 400 V

Fig.4-49: Characteristic curves of a MSK070C-0450 motor

4.13 MSK070D - Technical Data

Designation	Symbol	Unit	MSK070D-0150-NN	MSK070D-0300-NN	MSK070D-0450-NN
UL Files (UL)			E163211		
Continuous torque at standstill 60 K	M_{0_60}	Nm	17.5		
Continuous current at standstill 60 K	$I_{0_60(rms)}$	A	6.2	11.0	16.6
Continuous torque at standstill 100 K	M_{0_100}	Nm	20.0		
Continuous current at standstill 100 K	$I_{0_100(rms)}$	A	7.1	12.6	22.0
Continuous torque at standstill surface	M_{0_S}	Nm	26.3		
Continuous current at standstill surface	$I_{0_S(rms)}$	A	9.3	16.5	24.9
Maximum torque	M_{max}	Nm	52.5		
Maximum Current	$I_{max(rms)}$	A	24.8	33.0	49.8
Torque constant at 20 °C ¹⁾	K_{M_N}	Nm/A	3.10	1.75	1.16
Voltage constant at 20 °C ²⁾	K_{EMK_1000}	V/min ⁻¹	210.0	107.3	71.1
Winding resistance at 20 °C	R_{12}	ohms	3.20	0.75	0.37
Winding inductivity	L_{12}	mH	25.900	6.000	3.000
Discharge capacity of the component	C_{dis}	nF	5.0	4.5	
Number of pole pairs	p	-	6		
Moment of inertia of the rotor	J_{rot}	kg*m ²	0.00375		
Thermal time constant	T_{th}	min	23.0		
Maximum speed	n_{max}	min ⁻¹	2,700	4,900	6,000
Sound pressure level	L_P	dB[A]	<75		
Weight ³⁾	m	kg	14.0 (15.6)		
Ambient temperature in operation	T_{amb}	°C	0 ... 40		
Type of protection according to IEC 60529	---	-	IP65		
Insulation class according to DIN EN 60034-1	---	-	155		

Latest amendment: 2008-01-29

1) 2)

Manufacturing tolerance ±5 %

3)

(...) Values for motors with holding brake, sorted (holding brake 1, holding brake 2 ...)

Fig.4-50:

Technical data

Technical Data

Designation	Symbol	Unit	Holding brake 1
Holding torque	M_4	Nm	23.0
Rated voltage	U_N	V	24
Rated current	I_N	A	0.79
Connection time	t_1	ms	130
Disconnection time	t_2	ms	180
Moment of inertia of the holding brake	J_{rot}	kg*m ²	0.000300

Latest amendment: 2004-08-27

Fig.4-51: Holding brakes MSK070 - Technical data (optional)

Characteristic Motor Curves

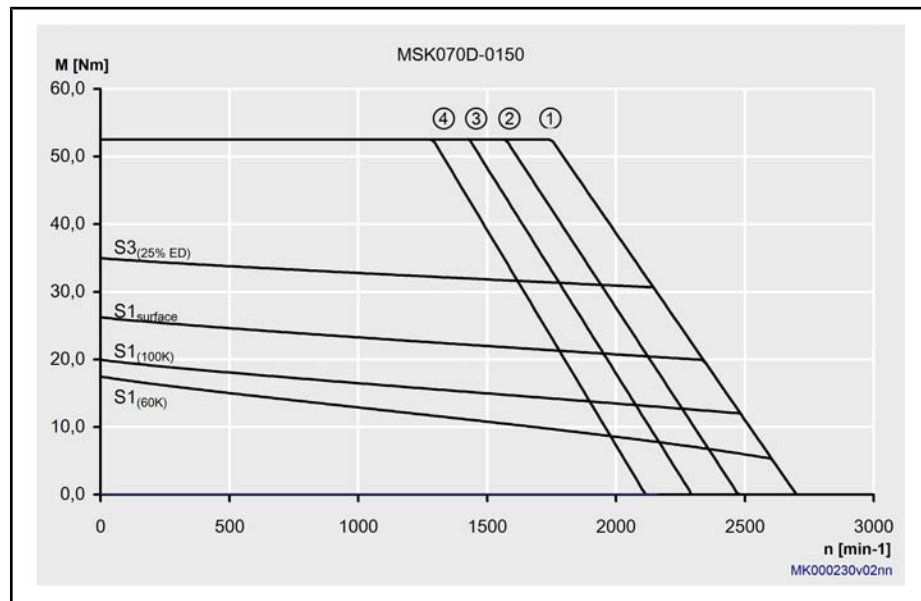

- ① Mmax for IndraDrive, controlled feed, 3 x AC 400 V
- ② Mmax for IndraDrive, uncontrolled feed, 3 x AC 480 V
- ③ Mmax for IndraDrive, uncontrolled feed, 3 x AC 440 V
- ④ Mmax for IndraDrive, uncontrolled feed, 3 x AC 400 V

Fig.4-52: Characteristic curves of a MSK070D-0150 motor

Technical Data

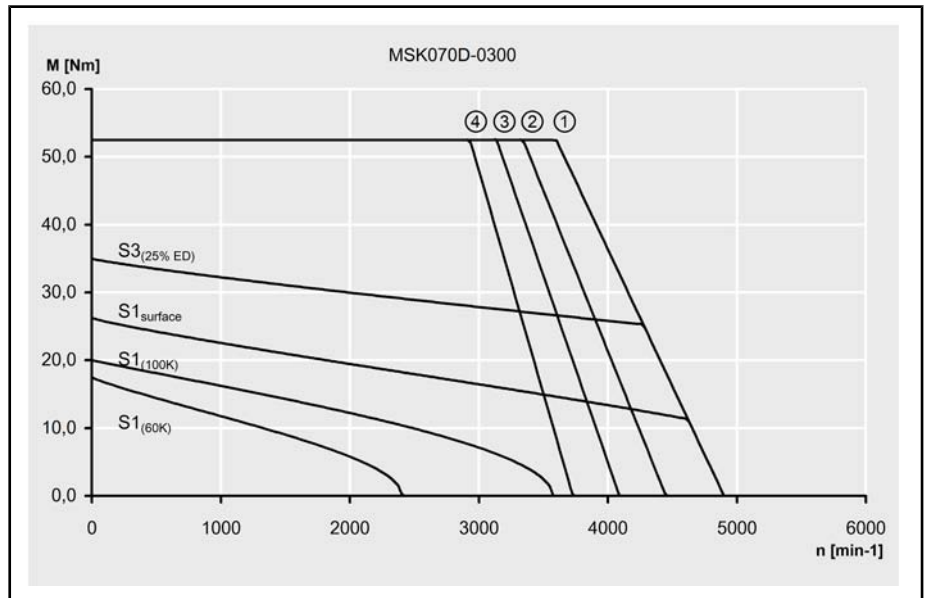

- ① Mmax for IndraDrive, controlled feed, 3 x AC 400 V
- ② Mmax for IndraDrive, uncontrolled feed, 3 x AC 480 V
- ③ Mmax for IndraDrive, uncontrolled feed, 3 x AC 440 V
- ④ Mmax for IndraDrive, uncontrolled feed, 3 x AC 400 V

Fig. 4-53: Characteristic curves of a MSK070D-0300 motor

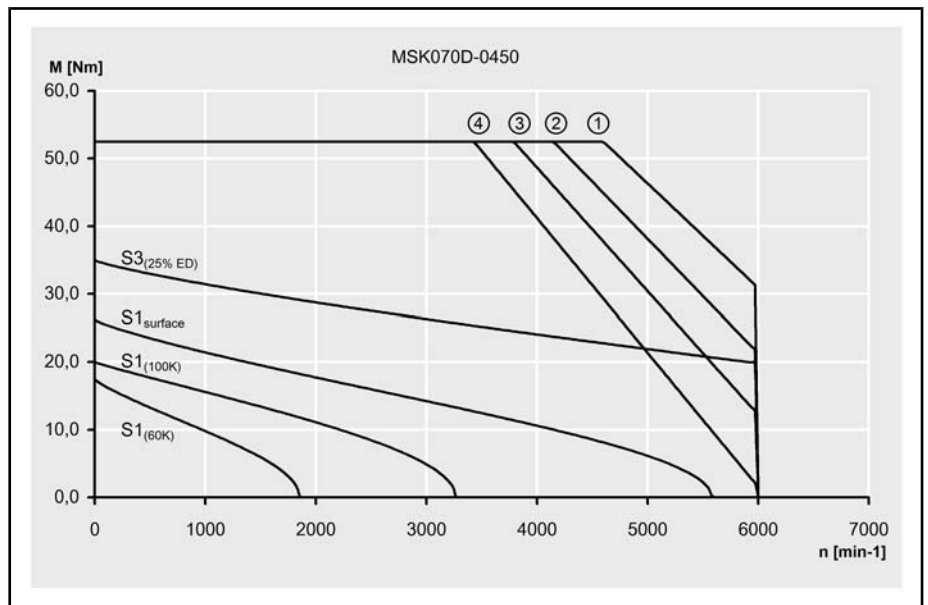

- ① Mmax for IndraDrive, controlled feed, 3 x AC 400 V
- ② Mmax for IndraDrive, uncontrolled feed, 3 x AC 480 V
- ③ Mmax for IndraDrive, uncontrolled feed, 3 x AC 440 V
- ④ Mmax for IndraDrive, uncontrolled feed, 3 x AC 400 V

Fig. 4-54: Characteristic curves of a MSK070D-0450 motor

Technical Data

4.14 MSK070E - Technical Data

Designation	Symbol	Unit	MSK070E-0150-NN	MSK070E-0300-NN	MSK070E-0450-NN
UL Files (UL)			E163211		
Continuous torque at standstill 60 K	M_{0_60}	Nm	23.0		
Continuous current at standstill 60 K	$I_{0_60(rms)}$	A	6.4	15.4	19.3
Continuous torque at standstill 100 K	M_{0_100}	Nm	25.0		
Continuous current at standstill 100 K	$I_{0_100(rms)}$	A	7.0	16.7	21.0
Continuous torque at standstill surface	M_{0_S}	Nm	34.5		
Continuous current at standstill surface	$I_{0_S(rms)}$	A	9.6	23.1	29.0
Maximum torque	M_{max}	Nm	70.0	65.0	60.0
Maximum Current	$I_{max(rms)}$	A	25.6	49.3	57.9
Torque constant at 20 °C ¹⁾	K_{M_N}	Nm/A	3.94	1.64	1.31
Voltage constant at 20 °C ²⁾	K_{EMK_1000}	V/min ⁻¹	242.4	101.0	80.6
Winding resistance at 20 °C	R_{12}	ohms	3.10	0.53	0.36
Winding inductivity	L_{12}	mH	24.500	3.900	2.700
Discharge capacity of the component	C_{dis}	nF	6.3	3.5	6.7
Number of pole pairs	p	-	6		
Moment of inertia of the rotor	J_{rot}	kg*m ²	0.00458		
Thermal time constant	T_{th}	min	32.0		
Maximum speed	n_{max}	min ⁻¹	2,200	5,300	6,000
Sound pressure level	L_P	dB[A]	<75		
Weight ³⁾	m	kg	16.2 (17.8)		
Ambient temperature in operation	T_{amb}	°C	0 ... 40		
Type of protection according to IEC 60529	---	-	IP65		
Insulation class according to DIN EN 60034-1	---	-	155		

Latest amendment: 2008-03-18

1) 2)

Manufacturing tolerance $\pm 5\%$

3)

(...) Values for motors with holding brake, sorted (holding brake 1, holding brake 2 ...)

Fig.4-55:

Technical data

Designation	Symbol	Unit	Holding brake 1
Holding torque	M_4	Nm	23.0
Rated voltage	U_N	V	24
Rated current	I_N	A	0.79
Connection time	t_1	ms	130
Disconnection time	t_2	ms	180
Moment of inertia of the holding brake	J_{rot}	kg*m ²	0.000300

Latest amendment: 2004-08-27

Fig.4-56: Holding brakes MSK070 - Technical data (optional)

Characteristic Motor Curves

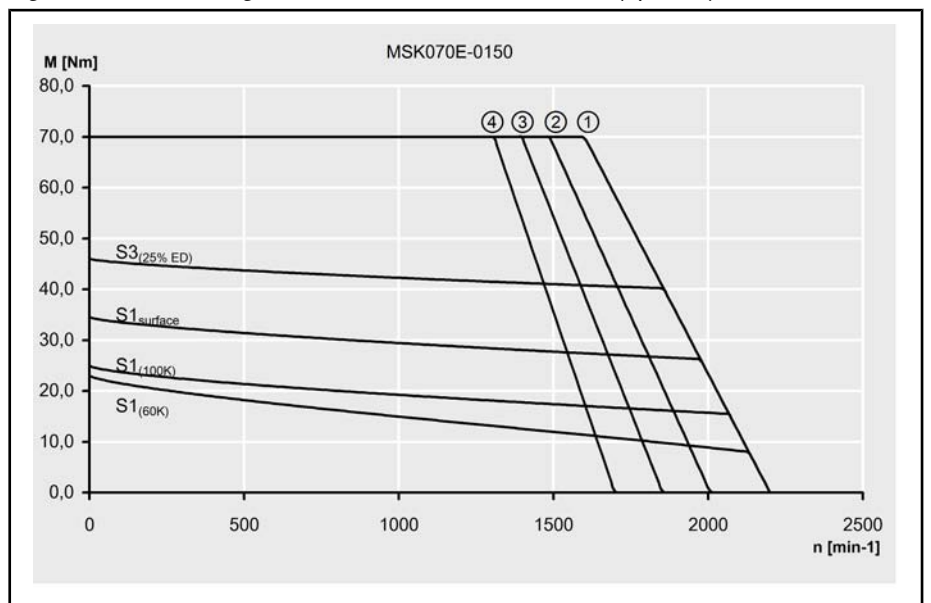

- ① Mmax for IndraDrive, controlled feed, 3 x AC 400 V
- ② Mmax for IndraDrive, uncontrolled feed, 3 x AC 480 V
- ③ Mmax for IndraDrive, uncontrolled feed, 3 x AC 440 V
- ④ Mmax for IndraDrive, uncontrolled feed, 3 x AC 400 V

Fig.4-57: Characteristic curves of a MSK070E-0150 motor

Technical Data

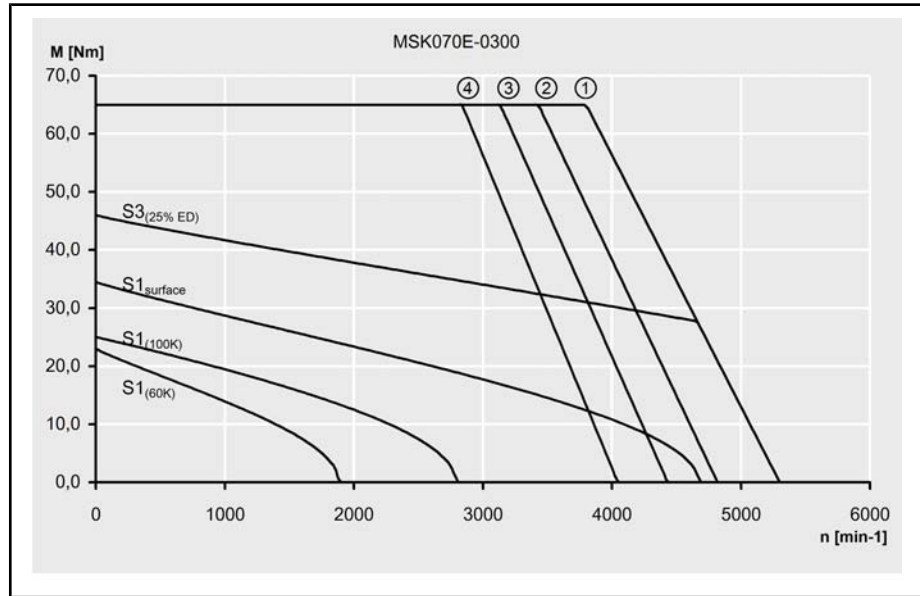

- ① Mmax for IndraDrive, controlled feed, 3 x AC 400 V
- ② Mmax for IndraDrive, uncontrolled feed, 3 x AC 480 V
- ③ Mmax for IndraDrive, uncontrolled feed, 3 x AC 440 V
- ④ Mmax for IndraDrive, uncontrolled feed, 3 x AC 400 V

Fig.4-58: Characteristic curves of a MSK070E-0300 motor

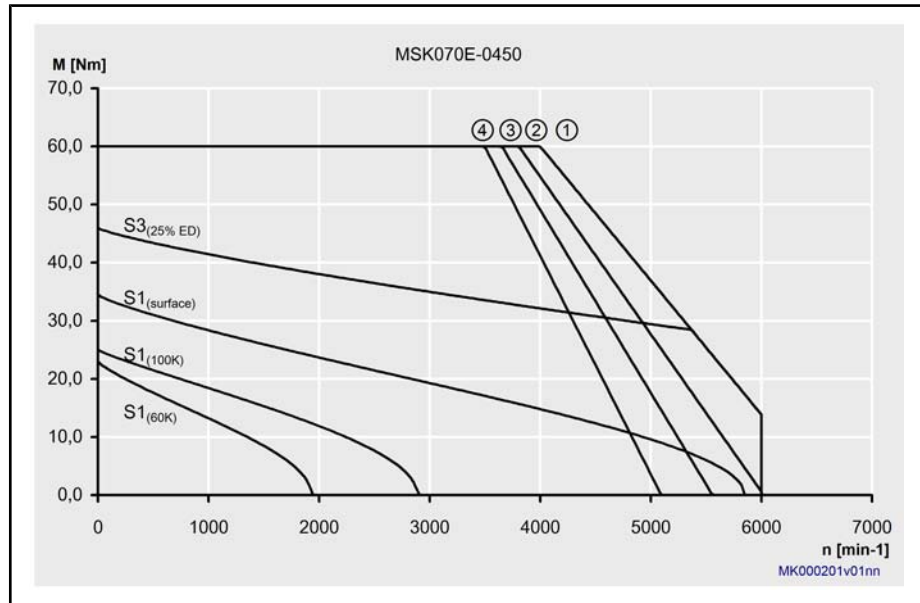

- ① Mmax for IndraDrive, controlled feed, 3 x AC 400 V
- ② Mmax for IndraDrive, uncontrolled feed, 3 x AC 480 V
- ③ Mmax for IndraDrive, uncontrolled feed, 3 x AC 440 V
- ④ Mmax for IndraDrive, uncontrolled feed, 3 x AC 400 V

Fig.4-59: Characteristic curves of a MSK070E-0450 motor

4.15 MSK071C - Technical Data

Designation	Symbol	Unit	MSK071C-0200-NN	MSK071C-0300-NN	MSK071C-0450-NN
UL Files (UL)			E163211		
Continuous torque at standstill 60 K	M_{0_60}	Nm	12.0		
Continuous current at standstill 60 K	$I_{0_60(rms)}$	A	5.2	7.3	8.9
Continuous torque at standstill 100 K	M_{0_100}	Nm	14.0		
Continuous current at standstill 100 K	$I_{0_100(rms)}$	A	6.1	8.5	10.4
Continuous torque at standstill surface	M_{0_S}	Nm	18.0		
Continuous current at standstill surface	$I_{0_S(rms)}$	A	7.8	11.0	13.4
Maximum torque	M_{max}	Nm	44.0		
Maximum Current	$I_{max(rms)}$	A	23.4	32.9	40.1
Torque constant at 20 °C ¹⁾	K_{M_N}	Nm/A	2.50	1.80	1.49
Voltage constant at 20 °C ²⁾	K_{EMK_1000}	V/min ⁻¹	155.5	110.5	91.3
Winding resistance at 20 °C	R_{12}	ohms	3.10	1.60	1.10
Winding inductivity	L_{12}	mH	19.500	10.900	6.700
Discharge capacity of the component	C_{dis}	nF	4.6		4.2
Number of pole pairs	p	-	4		
Moment of inertia of the rotor	J_{rot}	kg*m ²	0.00173		
Thermal time constant	T_{th}	min	15.0		
Maximum speed	n_{max}	min ⁻¹	3,500	5,000	5,800
Sound pressure level	L_P	dB[A]	<75		
Weight ³⁾	m	kg	13.9 (15.8)		
Ambient temperature in operation	T_{amb}	°C	0 ... 40		
Type of protection according to IEC 60529	---	-	IP65		
Insulation class according to DIN EN 60034-1	---	-	155		

Latest amendment: 2008-02-12

1) 2)

Manufacturing tolerance ±5 %

3)

(...) Values for motors with holding brake, sorted (holding brake 1, holding brake 2 ...)

Fig.4-60:

MSK - Technical data (standard and air cooling)

Technical Data

Designation	Symbol	Unit	MSK071C-0200-FN planned	MSK071C-0300-FN planned	MSK071C-0450-FN planned
UL Files (UL)			E163211		
Continuous torque at standstill 60 K	$M_{0,60}$	Nm	12.0		
Continuous current at standstill 60 K	$I_{0,60(rms)}$	A	5.2	7.3	8.9
Continuous torque at standstill 100 K	$M_{0,100}$	Nm	14.0		
Continuous current at standstill 100 K	$I_{0,100(rms)}$	A	6.1	8.5	10.4
Standstill continuous torque liquid	$M_{0,L}$	Nm	22.8		
Continuous standstill current liquid	$I_{0,L(rms)}$	A	9.9	13.9	16.9
Maximum torque	M_{max}	Nm	44.0		
Maximum Current	$I_{max(rms)}$	A	23.4	32.9	40.1
Torque constant at 20 °C ¹⁾	$K_{M,N}$	Nm/A	2.50	1.80	1.49
Voltage constant at 20 °C ²⁾	$K_{EMK,1000}$	V/min ⁻¹	155.5	110.5	91.3
Winding resistance at 20 °C	R_{12}	ohms	3.10	1.60	1.10
Winding inductivity	L_{12}	mH	19.500	10.900	6.700
Discharge capacity of the component	C_{dis}	nF	4.6		4.2
Number of pole pairs	p	-	4		
Moment of inertia of the rotor	J_{rot}	kg*m ²	0.00173		
Thermal time constant	T_{th}				3.0
Maximum speed	n_{max}	min ⁻¹	3,500	5,000	5,800
Sound pressure level	L_P	dB[A]	<75		
Weight ³⁾	m	kg	13.9 (15.8)		
Ambient temperature in operation	T_{amb}	°C	0 ... 40		
Type of protection according to IEC 60529	---	-	IP65		
Insulation class according to DIN EN 60034-1	---	-	155		
Data liquid cooling					
Power loss to be dissipated	P_V	kW	tbd		
Coolant inlet temperature	T_{ein}	°C	10 ... 40		
Permitted coolant temperature rise at P_V	ΔT	K	10		
Required coolant flow at P_V	Q_{min}	l/min	tbd		
Latest amendment: 2008-05-13					

Designation	Symbol	Unit	MSK071C-0200-FN planned	MSK071C-0300-FN planned	MSK071C-0450-FN planned
Pressure loss at Q_{min}	Δp	bar	tbd		
Maximum permitted inlet pressure	p_{max}	bar	3.0		
Volume of coolant duct	V_{kuehl}	l	tbd		
Latest amendment: 2008-05-13					

1) 2) Manufacturing tolerance $\pm 5\%$
 3) (...) Values for motors with holding brake, sorted (holding brake 1, holding brake 2 ...)

Fig.4-61: MSK - Technical data (standard and liquid cooling)

Designation	Symbol	Unit	Holding brake 1	Holding brake 2
Holding torque	M_4	Nm	23.0	30.0
Rated voltage	U_N	V	24	
Rated current	I_N	A	0.79	0.94
Connection time	t_1	ms	130	35
Disconnection time	t_2	ms	180	125
Moment of inertia of the holding brake	J_{rot}	kg*m ²	0.000300	0.001060
Latest amendment: 2007-07-19				

Fig.4-62: Holding brakes MSK071 - Technical data (optional)

Characteristic Motor Curves

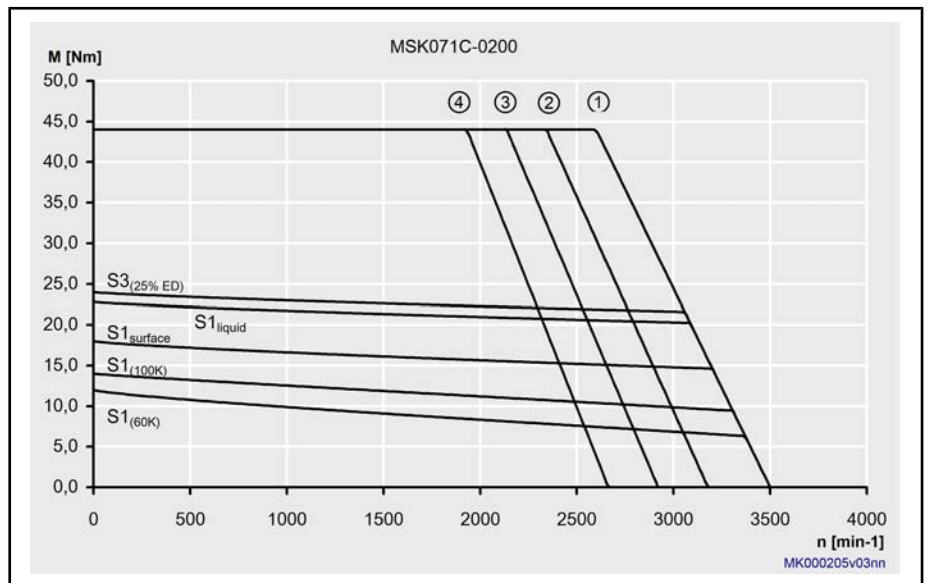

- ① Mmax for IndraDrive, controlled feed, 3 x AC 400 V
- ② Mmax for IndraDrive, uncontrolled feed, 3 x AC 480 V
- ③ Mmax for IndraDrive, uncontrolled feed, 3 x AC 440 V
- ④ Mmax for IndraDrive, uncontrolled feed, 3 x AC 400 V

Fig.4-63: Characteristic curves of an MSK071C-0200 motor

Technical Data

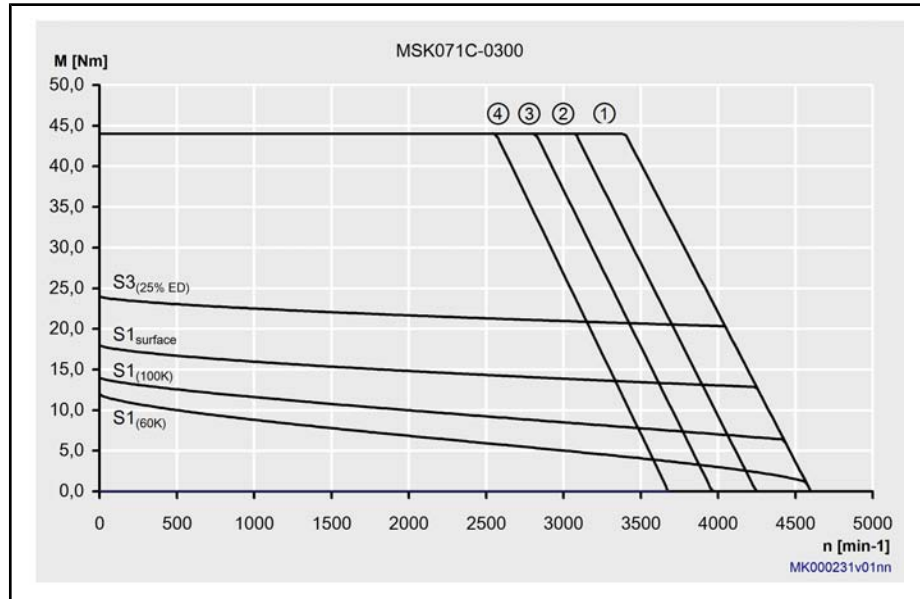

- ① Mmax for IndraDrive, controlled feed, 3 x AC 400 V
- ② Mmax for IndraDrive, uncontrolled feed, 3 x AC 480 V
- ③ Mmax for IndraDrive, uncontrolled feed, 3 x AC 440 V
- ④ Mmax for IndraDrive, uncontrolled feed, 3 x AC 400 V

Fig.4-64: Characteristic curves of an MSK071C-0300 motor

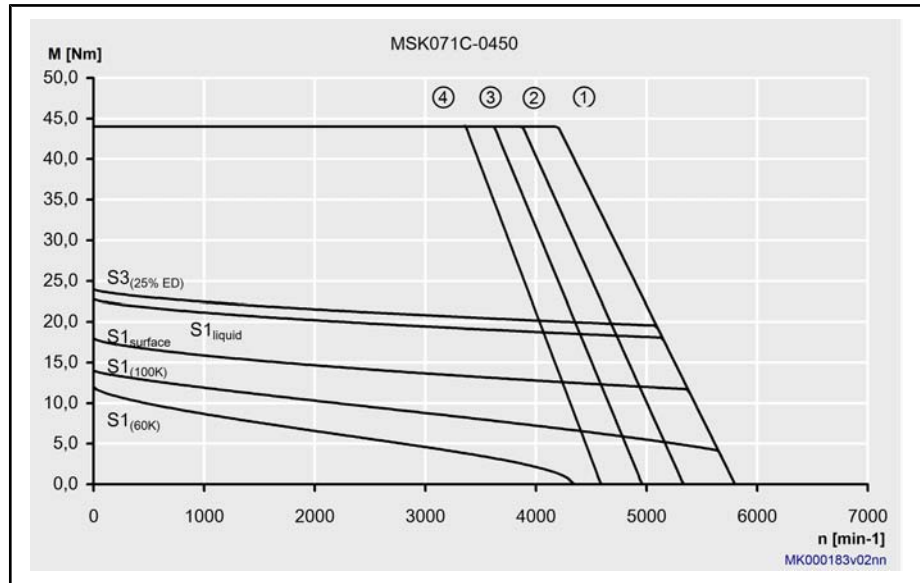

- ① Mmax for IndraDrive, controlled feed, 3 x AC 400 V
- ② Mmax for IndraDrive, uncontrolled feed, 3 x AC 480 V
- ③ Mmax for IndraDrive, uncontrolled feed, 3 x AC 440 V
- ④ Mmax for IndraDrive, uncontrolled feed, 3 x AC 400 V

Fig.4-65: Characteristic curves of an MSK071C-0450 motor

4.16 MSK071D - Technical Data

Designation	Symbol	Unit	MSK071D-0200-NN	MSK071D-0300-NN	MSK071D-0450-NN
UL Files (UL)			E163211		
Continuous torque at standstill 60 K	M_{0_60}	Nm	17.5		
Continuous current at standstill 60 K	$I_{0_60(rms)}$	A	7.3	9.1	15.4
Continuous torque at standstill 100 K	M_{0_100}	Nm	20.0		
Continuous current at standstill 100 K	$I_{0_100(rms)}$	A	8.6	10.7	17.6
Continuous torque at standstill surface	M_{0_S}	Nm	26.3		
Continuous current at standstill surface	$I_{0_S(rms)}$	A	11.0	13.5	23.1
Maximum torque	M_{max}	Nm	66.0		
Maximum Current	$I_{max(rms)}$	A	32.8	40.5	69.3
Torque constant at 20 °C ¹⁾	K_{M_N}	Nm/A	2.63	2.12	1.25
Voltage constant at 20 °C ²⁾	K_{EMK_1000}	V/min ⁻¹	162.0	134.0	77.1
Winding resistance at 20 °C	R_{12}	ohms	1.90	1.26	0.45
Winding inductivity	L_{12}	mH	14.200	10.700	3.200
Discharge capacity of the component	C_{dis}	nF	6.9	7.2	7.8
Number of pole pairs	p	-	4		
Moment of inertia of the rotor	J_{rot}	kg*m ²	0.00255		
Thermal time constant	T_{th}	min	54.0		52.0
Maximum speed	n_{max}	min ⁻¹	3,200	3,800	6,000
Sound pressure level	L_P	dB[A]	<75		
Weight ³⁾	m	kg	18.0 (19.6)		
Ambient temperature in operation	T_{amb}	°C	0 ... 40		
Type of protection according to IEC 60529	---	-	IP65		
Insulation class according to DIN EN 60034-1	---	-	155		

Latest amendment: 2008-01-29

1) 2)

Manufacturing tolerance ±5 %

3)

(...) Values for motors with holding brake, sorted (holding brake 1, holding brake 2 ...)

Fig.4-66:

Technical data

Technical Data

Designation	Symbol	Unit	MSK071D-0200-FN	MSK071D-0300-FN	MSK071D-0450-FN
UL Files (UL)			E163211		
Continuous torque at standstill 60 K	M_{0_60}	Nm	17.5		
Continuous current at standstill 60 K	$I_{0_60(rms)}$	A	7.3	9.1	15.4
Continuous torque at standstill 100 K	M_{0_100}	Nm	20.0		
Continuous current at standstill 100 K	$I_{0_100(rms)}$	A	8.6	10.7	17.6
Standstill continuous torque liquid	M_{0_L}	Nm	33.3		
Continuous standstill current liquid	$I_{0_L(rms)}$	A	13.9	17.2	30.3
Maximum torque	M_{max}	Nm	66.0		
Maximum Current	$I_{max(rms)}$	A	32.8	40.5	69.3
Torque constant at 20 °C ¹⁾	K_{M_N}	Nm/A	2.63	2.12	1.25
Voltage constant at 20 °C ²⁾	K_{EMK_1000}	V/min ⁻¹	162.0	134.0	77.1
Winding resistance at 20 °C	R_{12}	ohms	1.90	1.26	0.45
Winding inductivity	L_{12}	mH	14.200	10.700	3.200
Discharge capacity of the component	C_{dis}	nF	6.9	7.2	7.8
Number of pole pairs	p	-	4		
Moment of inertia of the rotor	J_{rot}	kg*m ²	0.00255		
Thermal time constant	T_{th}	min	54.0		52.0
Maximum speed	n_{max}	min ⁻¹	3200	3800	6000
Sound pressure level	L_P	dB[A]	<75		
Weight ³⁾	m	kg	18.0 (19.6)		
Ambient temperature in operation	T_{amb}	°C	0 ... 40		
Type of protection according to IEC 60529	---	-	IP65		
Insulation class according to DIN EN 60034-1	---	-	155		
Data liquid cooling					
Power loss to be dissipated	P_V	kW	900.00		
Coolant inlet temperature	T_{ein}	°C	10 ... 40		
Permitted coolant temperature rise at P_V	ΔT	K	10		

Latest amendment: 2008-05-13

Designation	Symbol	Unit	MSK071D-0200-FN	MSK071D-0300-FN	MSK071D-0450-FN
Required coolant flow at Pv	Q_{min}	l/min	1.3		
Pressure loss at Q_{min}	Δp	bar	0.6		
Maximum permitted inlet pressure	p_{max}	bar	3.0		
Volume of coolant duct	V_{kuehl}	l	0.05		

Latest amendment: 2008-05-13

1) 2) Manufacturing tolerance $\pm 5\%$
 3) (...) Values for motors with holding brake, sorted (holding brake 1, holding brake 2 ...)

Fig.4-67: MSK - Technical data (standard and liquid cooling)

Designation	Symbol	Unit	Holding brake 1	Holding brake 2
Holding torque	M_4	Nm	23.0	30.0
Rated voltage	U_N	V	24	
Rated current	I_N	A	0.79	0.94
Connection time	t_1	ms	130	35
Disconnection time	t_2	ms	180	125
Moment of inertia of the holding brake	J_{rot}	kg*m ²	0.000300	0.001060

Latest amendment: 2007-07-19

Fig.4-68: Holding brakes MSK071 - Technical data (optional)

Characteristic Motor Curves

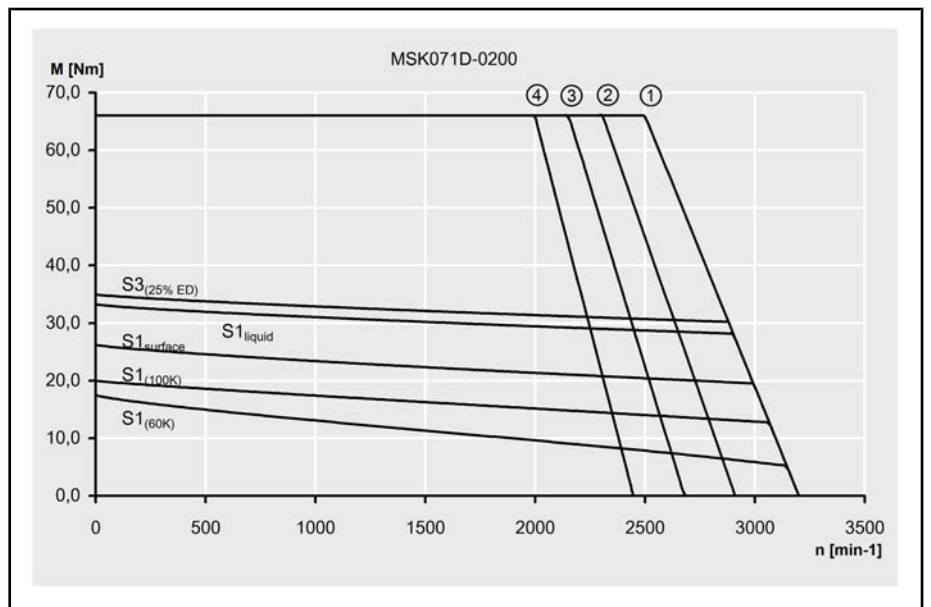

- ① Mmax for IndraDrive, controlled feed, 3 x AC 400 V
- ② Mmax for IndraDrive, uncontrolled feed, 3 x AC 480 V
- ③ Mmax for IndraDrive, uncontrolled feed, 3 x AC 440 V
- ④ Mmax for IndraDrive, uncontrolled feed, 3 x AC 400 V

Fig.4-69: Characteristic curves of a MSK071D-0200 motor

Technical Data

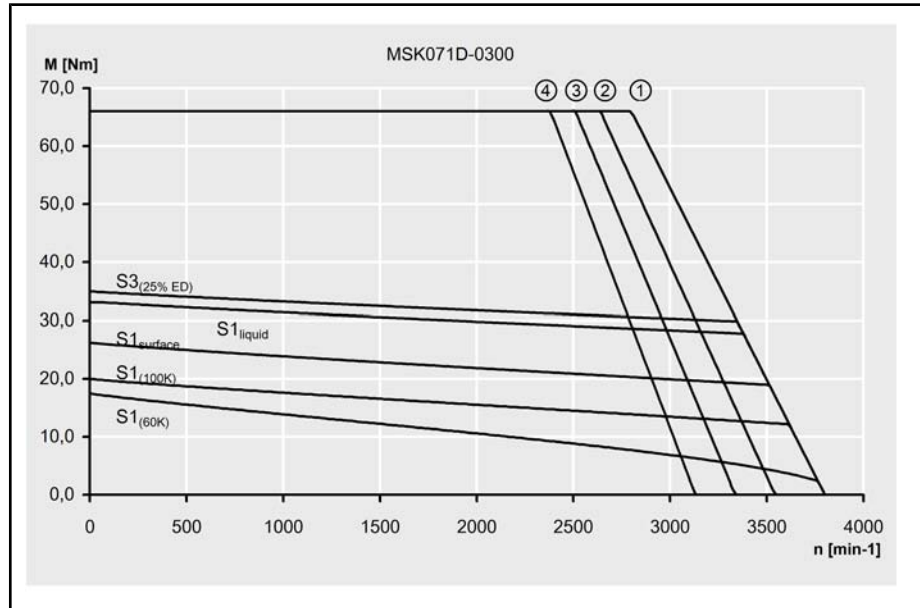

- ① Mmax for IndraDrive, controlled feed, 3 x AC 400 V
- ② Mmax for IndraDrive, uncontrolled feed, 3 x AC 480 V
- ③ Mmax for IndraDrive, uncontrolled feed, 3 x AC 440 V
- ④ Mmax for IndraDrive, uncontrolled feed, 3 x AC 400 V

Fig.4-70: Characteristic curves of a MSK071D-0300 motor

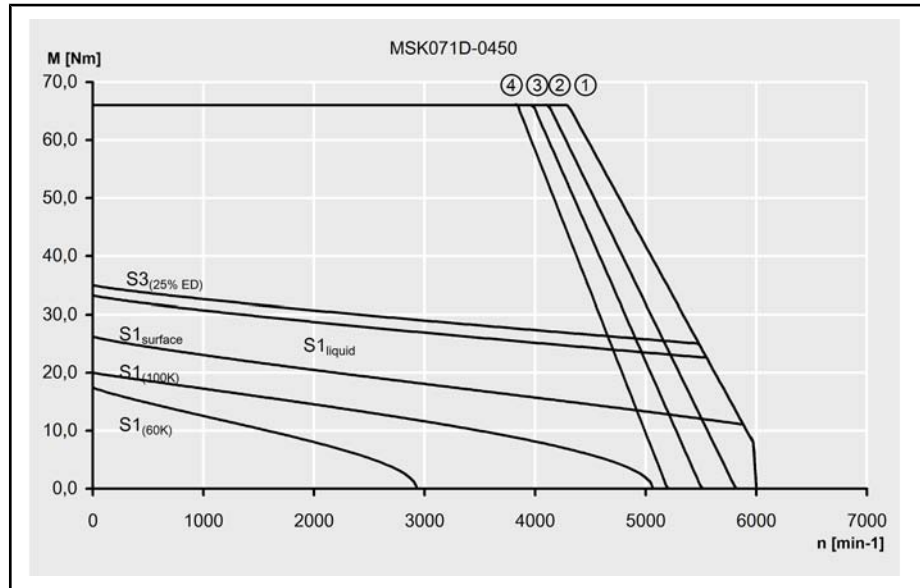

- ① Mmax for IndraDrive, controlled feed, 3 x AC 400 V
- ② Mmax for IndraDrive, uncontrolled feed, 3 x AC 480 V
- ③ Mmax for IndraDrive, uncontrolled feed, 3 x AC 440 V
- ④ Mmax for IndraDrive, uncontrolled feed, 3 x AC 400 V

Fig.4-71: Characteristic curves of a MSK071D-0450 motor

4.17 MSK071E - Technical Data

Designation	Symbol	Unit	MSK071E-0200-NN	MSK071E-0300-NN	MSK071E-0450-NN
UL Files (UL)			E163211		
Continuous torque at standstill 60 K	M_{0_60}	Nm	23.0		
Continuous current at standstill 60 K	$I_{0_60(rms)}$	A	10.1	12.5	20.0
Continuous torque at standstill 100 K	M_{0_100}	Nm	28.0		
Continuous current at standstill 100 K	$I_{0_100(rms)}$	A	12.6	15.2	24.4
Continuous torque at standstill surface	M_{0_S}	Nm	34.5		
Continuous current at standstill surface	$I_{0_S(rms)}$	A	15.2	18.8	30.0
Maximum torque	M_{max}	Nm	84.0		
Maximum Current	$I_{max(rms)}$	A	45.5	56.3	90.1
Torque constant at 20 °C ¹⁾	K_{M_N}	Nm/A	2.51	2.05	1.29
Voltage constant at 20 °C ²⁾	K_{EMK_1000}	V/min ⁻¹	154.6	126.4	82.7
Winding resistance at 20 °C	R_{12}	ohms	1.16	0.79	0.32
Winding inductivity	L_{12}	mH	9.150	5.900	2.600
Discharge capacity of the component	C_{dis}	nF	8.9	9.3	9.5
Number of pole pairs	p	-	4		
Moment of inertia of the rotor	J_{rot}	kg*m ²	0.00290		
Thermal time constant	T_{th}	min	75.0	19.8	
Maximum speed	n_{max}	min ⁻¹	3,400	4,200	6,000
Sound pressure level	L_P	dB[A]	<75		
Weight ³⁾	m	kg	23.5 (25.1)		
Ambient temperature in operation	T_{amb}	°C	0 ... 40		
Type of protection according to IEC 60529	---	-	IP65		
Insulation class according to DIN EN 60034-1	---	-	155		

Latest amendment: 2008-05-30

1) 2)

Manufacturing tolerance ±5 %

3)

(...) Values for motors with holding brake, sorted (holding brake 1, holding brake 2 ...)

Fig.4-72:

Technical data

Technical Data

Designation	Symbol	Unit	MSK071E-0200-FN	MSK071E-0300-FN	MSK071E-0450-FN
UL Files (UL)			E163211		
Continuous torque at standstill 60 K	M_{0_60}	Nm	23.0		
Continuous current at standstill 60 K	$I_{0_60(rms)}$	A	10.1	12.5	20.0
Continuous torque at standstill 100 K	M_{0_100}	Nm	28.0		
Continuous current at standstill 100 K	$I_{0_100(rms)}$	A	12.6	15.2	24.4
Standstill continuous torque liquid	M_{0_L}	Nm	43.7		
Continuous standstill current liquid	$I_{0_L(rms)}$	A	19.0	24.9	38.0
Maximum torque	M_{max}	Nm	84.0		
Maximum Current	$I_{max(rms)}$	A	45.5	56.3	90.1
Torque constant at 20 °C ¹⁾	K_{M_N}	Nm/A	2.51	2.05	1.29
Voltage constant at 20 °C ²⁾	K_{EMK_1000}	V/min ⁻¹	154.6	126.4	82.7
Winding resistance at 20 °C	R_{12}	ohms	1.16	0.79	0.32
Winding inductivity	L_{12}	mH	9.150	5.900	2.600
Discharge capacity of the component	C_{dis}	nF	8.9	9.3	9.5
Number of pole pairs	p	-	4		
Moment of inertia of the rotor	J_{rot}	kg*m ²	0.00290		
Thermal time constant	T_{th}	min	25.0	19.8	
Maximum speed	n_{max}	min ⁻¹	3,400	4,200	6,000
Sound pressure level	L_P	dB[A]	<75		
Weight ³⁾	m	kg	23.5 (25.1)		
Ambient temperature in operation	T_{amb}	°C	0 ... 40		
Type of protection according to IEC 60529	---	-	IP65		
Insulation class according to DIN EN 60034-1	---	-	155		
Data liquid cooling					
Power loss to be dissipated	P_V	kW	1,000.00		
Coolant inlet temperature	T_{ein}	°C	10 ... 40		
Permitted coolant temperature rise at P_V	ΔT	K	10		
Latest amendment: 2008-05-30					

Designation	Symbol	Unit	MSK071E-0200-FN	MSK071E-0300-FN	MSK071E-0450-FN
Required coolant flow at Pv	Q_{min}	l/min	1.4		
Pressure loss at Q_{min}	Δp	bar	0.7		
Maximum permitted inlet pressure	p_{max}	bar	3.0		
Volume of coolant duct	V_{kuehl}	l	0.06		

Latest amendment: 2008-05-30

1) 2) Manufacturing tolerance $\pm 5\%$
 3) (...) Values for motors with holding brake, sorted (holding brake 1, holding brake 2 ...)

Fig.4-73: MSK - Technical data (standard and liquid cooling)

Designation	Symbol	Unit	Holding brake 1	Holding brake 2
Holding torque	M_4	Nm	23.0	30.0
Rated voltage	U_N	V	24	
Rated current	I_N	A	0.79	0.94
Connection time	t_1	ms	130	35
Disconnection time	t_2	ms	180	125
Moment of inertia of the holding brake	J_{rot}	kg*m ²	0.000300	0.001060

Latest amendment: 2007-07-19

Fig.4-74: Holding brakes MSK071 - Technical data (optional)

Characteristic Motor Curves

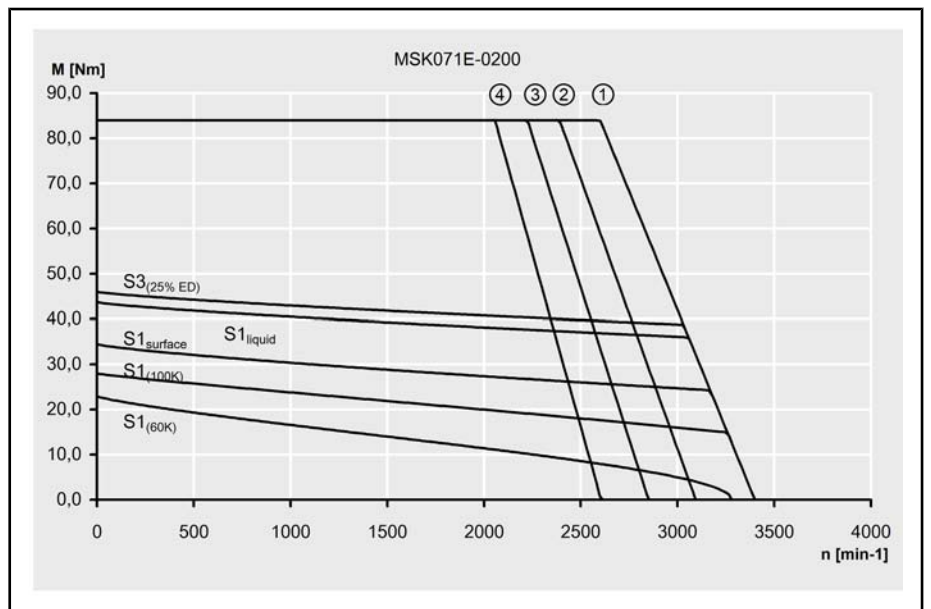

- ① Mmax for IndraDrive, controlled feed, 3 x AC 400 V
- ② Mmax for IndraDrive, uncontrolled feed, 3 x AC 480 V
- ③ Mmax for IndraDrive, uncontrolled feed, 3 x AC 440 V
- ④ Mmax for IndraDrive, uncontrolled feed, 3 x AC 400 V

Fig.4-75: Characteristic curves of a MSK071E-0200 motor

Technical Data

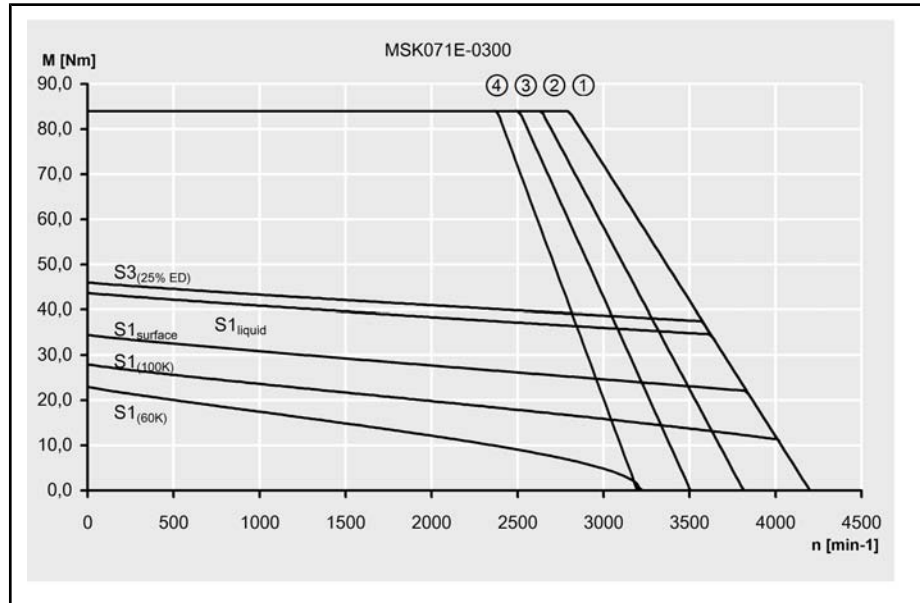

- ① Mmax for IndraDrive, controlled feed, 3 x AC 400 V
- ② Mmax for IndraDrive, uncontrolled feed, 3 x AC 480 V
- ③ Mmax for IndraDrive, uncontrolled feed, 3 x AC 440 V
- ④ Mmax for IndraDrive, uncontrolled feed, 3 x AC 400 V

Fig.4-76: Characteristic curves of a MSK071E-0300 motor

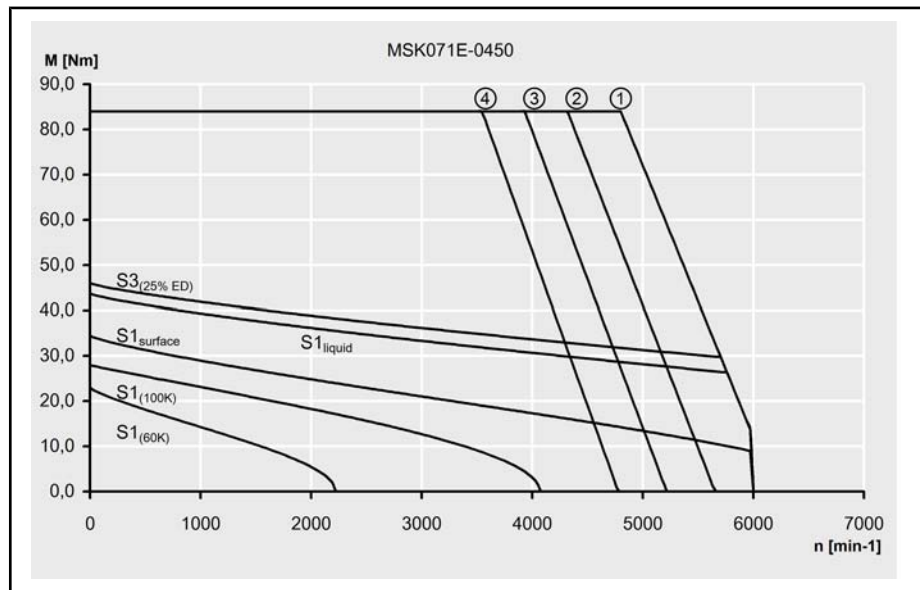

- ① Mmax for IndraDrive, controlled feed, 3 x AC 400 V
- ② Mmax for IndraDrive, uncontrolled feed, 3 x AC 480 V
- ③ Mmax for IndraDrive, uncontrolled feed, 3 x AC 440 V
- ④ Mmax for IndraDrive, uncontrolled feed, 3 x AC 400 V

Fig.4-77: Characteristic curves of a MSK071E-0450 motor

4.18 MSK075C Technical Data

Description	Symbol	Unit	MSK075C-0300-NN	MSK075C-0450-NN
UL-Files (UL)			E163211	
Standstill continuous torque 60 K	M_{0_60}	Nm	12.0	
Continuous standstill current 60 K	$I_{0_60(\text{eff})}$	A	8.4	12.6
Standstill continuous torque 100 K	M_{0_100}	Nm	12.5	
Continuous standstill current 100 K	$I_{0_100(\text{eff})}$	A	8.8	13.1
Standstill continuous torque surface	M_{0_S}	Nm	18.0	
Continuous standstill current surface	$I_{0_S(\text{eff})}$	A	12.6	18.9
Maximum torque	M_{max}	Nm	44.0	
Maximum current	$I_{\text{max}(\text{eff})}$	A	37.8	56.7
Torque constant at 20 °C ¹⁾	K_{M_N}	Nm/A	1.58	1.05
Torque constant at 20 °C ²⁾	$K_{\text{EMK}_1,000}$	V/min ⁻¹	97.0	64.8
Winding resistance at 20 °C	R_{12}	Ohm	1.60	0.76
Winding inductivity	L_{12}	mH	8.800	4.200
Discharge capacity of the component	C_{ab}	nF	3.2	3.5
Number of pole pairs	p	-	4	
Rotor moment of inertia	J_{rot}	kg*m ²	0.00352	
Thermal time constant	T_{th}	min	29.0	17.5
Maximum speed	n_{max}	min ⁻¹	5,000	6,000
Sound pressure level	L_P	dB[A]	<75	
Weight ³⁾	m	kg	14.8(16.4)	
Ambient temperature in operation	T_{um}	°C	0 ... 40	
Degree of protection according to IEC60529	---	-	IP65	
Insulation class according to DIN EN 60034-1	---	-	155	

Latest amendment: 2008-06-09

1) 2)

Manufacturing tolerance ±5%

3)

(...) values for motors with holding brakes, sorted (holding brake 1, holding brake 2 ...)

Fig.4-78:

MSK - technical data (standard and air-cooling)

Technical Data

Description	Symbol	Unit	Holding brake 1
Holding torque	M_4	Nm	23.0
Rated voltage	U_N	V	24
Rated current	I_N	A	0.79
Connection time	t_1	ms	130
Disconnection time	t_2	ms	180
Moment of inertia of the holding brake	J_{rot}	kg*m ²	0.000300

Latest amendment: 2004-08-27

Fig.4-79: Holding brake - technical data (optional)

Motor characteristic curves

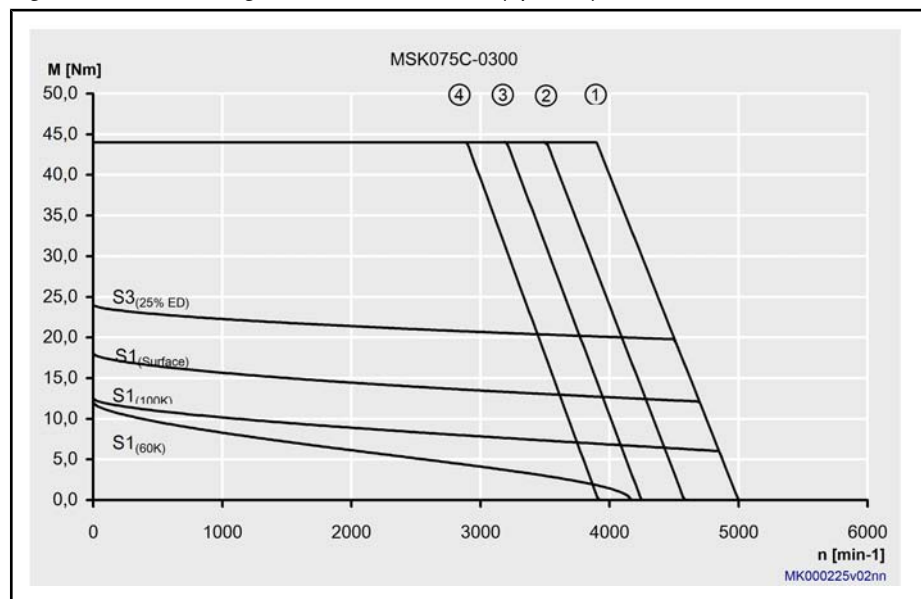

- ① Mmax for IndraDrive, controlled feed, 3 x AC 400V
- ② Mmax for IndraDrive, uncontrolled feed, 3 x AC 480V
- ③ Mmax for IndraDrive, uncontrolled feed, 3 x AC 440V
- ④ Mmax for IndraDrive, uncontrolled feed, 3 x AC 400V

Fig.4-80: Motor characteristic curve MSK075C-300

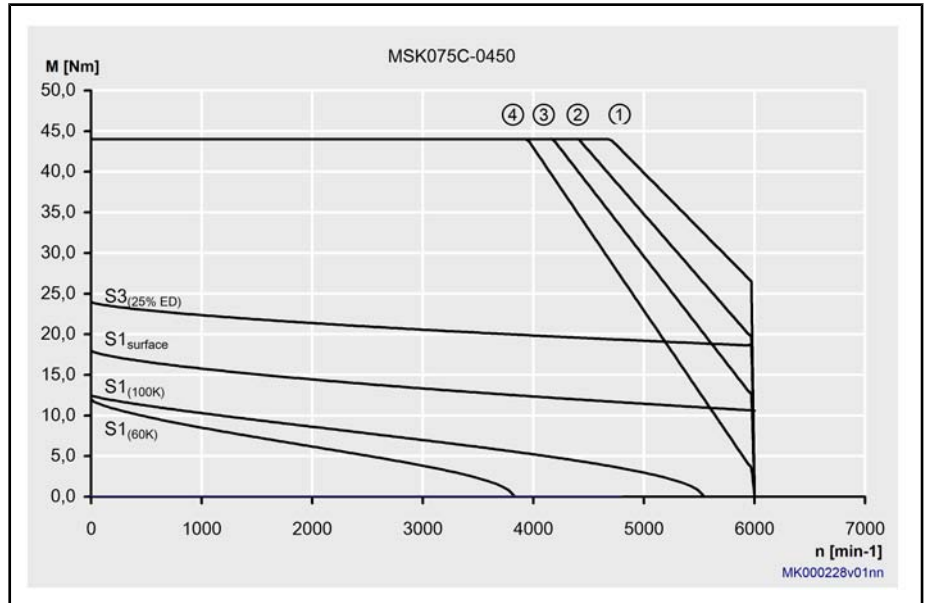

- ① Mmax for IndraDrive, controlled feed, 3 x AC 400V
- ② Mmax for IndraDrive, uncontrolled feed, 3 x AC 480V
- ③ Mmax for IndraDrive, uncontrolled feed, 3 x AC 440V
- ④ Mmax for IndraDrive, uncontrolled feed, 3 x AC 400V

Fig.4-81: Motor characteristic curve MSK075C-0450

Technical Data

4.19 MSK075D Technical Data

Description	Symbol	Unit	MSK075D-0200-NN	MSK075D-0300-NN	MSK075D-0450-NN
UL-Files (UL)			E163211		
Standstill continuous torque 60 K	M_{0_60}	Nm	17.0		
Continuous standstill current 60 K	$I_{0_60(\text{eff})}$	A	8.3	11.7	16.5
Standstill continuous torque 100 K	M_{0_100}	Nm	18.5		
Continuous standstill current 100 K	$I_{0_100(\text{eff})}$	A	9.0	12.7	18.0
Standstill continuous torque surface	M_{0_S}	Nm	25.5		
Continuous standstill current surface	$I_{0_S(\text{eff})}$	A	12.5	17.6	24.8
Maximum torque	M_{max}	Nm	64.0	66.0	64.0
Maximum current	$I_{\text{max}(\text{eff})}$	A	37.4	52.7	74.3
Torque constant at 20 °C ¹⁾	K_{M_N}	Nm/A	2.24	1.60	1.13
Torque constant at 20 °C ²⁾	$K_{EMK_1,000}$	V/min ⁻¹	138.0	98.2	69.3
Winding resistance at 20 °C	R_{12}	Ohm	1.80	0.91	0.45
Winding inductivity	L_{12}	mH	11.700	5.700	2.900
Discharge capacity of the component	C_{ab}	nF	4.6	4.7	
Number of pole pairs	p	-	4		
Rotor moment of inertia	J_{rot}	kg*m ²	0.00490		
Thermal time constant	T_{th}	min	22.0	17.5	22.0
Maximum speed	n_{max}	min ⁻¹	3,800	4,800	6,000
Sound pressure level	L_p	dB[A]	<75		
Weight ³⁾	m	kg	19.0 (20.1)		
Ambient temperature in operation	T_{um}	°C	0 ... 40		
Degree of protection according to IEC60529	---	-	IP65		
Insulation class according to DIN EN 60034-1	---	-	155		

Latest amendment: 2008-05-26

1) 2)

Manufacturing tolerance ±5%

3)

(...) values for motors with holding brakes, sorted (holding brake 1, holding brake 2 ...)

Fig.4-82:

MSK - technical data (standard and air-cooling)

Description	Symbol	Unit	Holding brake 1
Holding torque	M_4	Nm	23.0
Rated voltage	U_N	V	24
Rated current	I_N	A	0.79
Connection time	t_1	ms	130
Disconnection time	t_2	ms	180
Moment of inertia of the holding brake	J_{rot}	kg*m ²	0.000300

Latest amendment: 2004-08-27

Fig.4-83: Holding brake - technical data (optional)

Motor characteristic curves

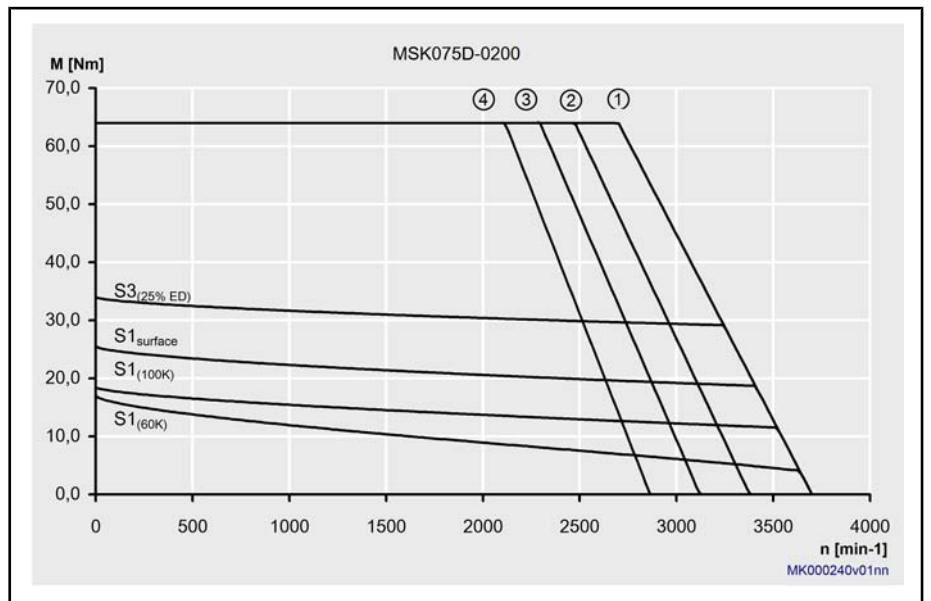

- ① Mmax for IndraDrive, controlled feed, 3 x AC 400V
- ② Mmax for IndraDrive, uncontrolled feed, 3 x AC 480V
- ③ Mmax for IndraDrive, uncontrolled feed, 3 x AC 440V
- ④ Mmax for IndraDrive, uncontrolled feed, 3 x AC 400V

Fig.4-84: Motor characteristic curve MSK075D-0200

Technical Data

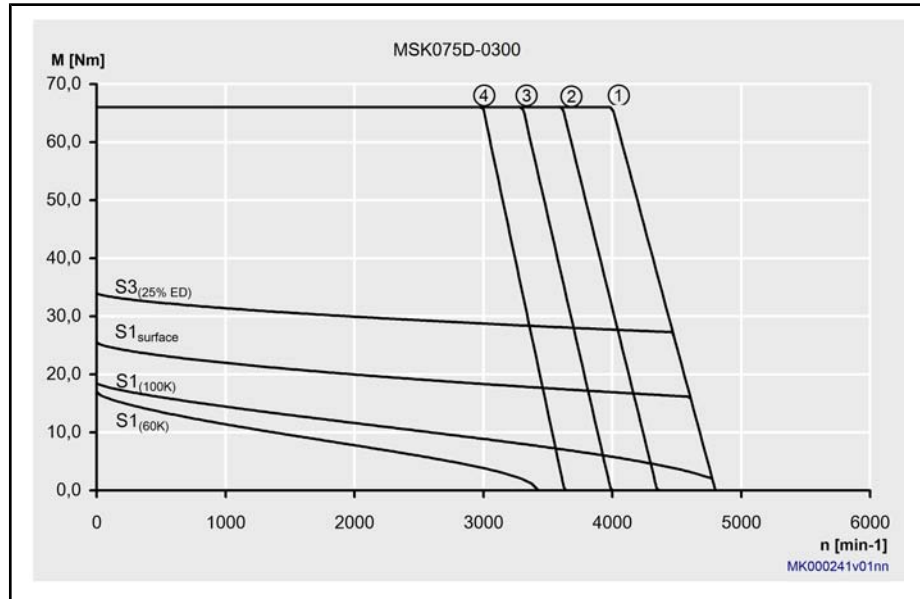

- ① Mmax for IndraDrive, controlled feed, 3 x AC 400V
- ② Mmax for IndraDrive, uncontrolled feed, 3 x AC 480V
- ③ Mmax for IndraDrive, uncontrolled feed, 3 x AC 440V
- ④ Mmax for IndraDrive, uncontrolled feed, 3 x AC 400V

Fig.4-85: Motor characteristic curve MSK075D-0300

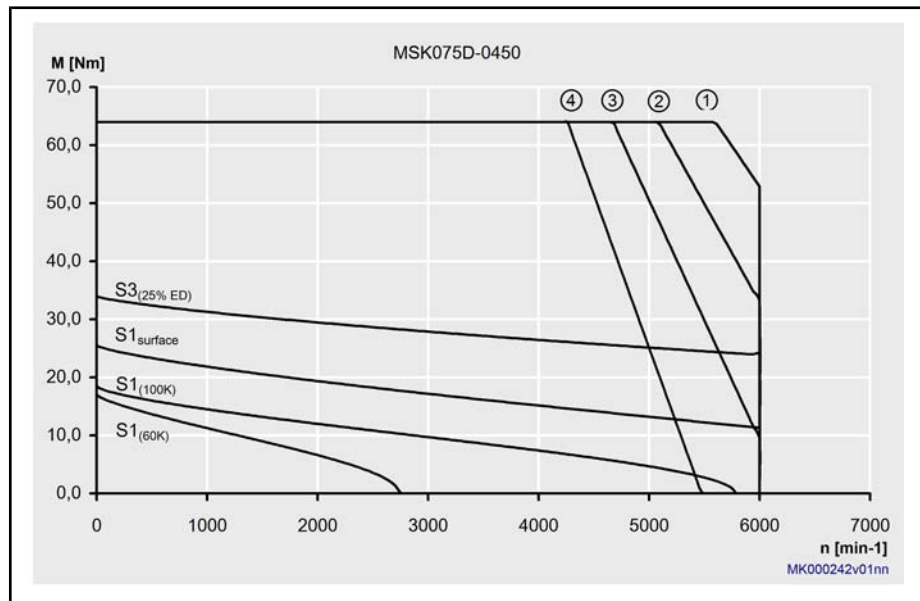

- ① Mmax for IndraDrive, controlled feed, 3 x AC 400V
- ② Mmax for IndraDrive, uncontrolled feed, 3 x AC 480V
- ③ Mmax for IndraDrive, uncontrolled feed, 3 x AC 440V
- ④ Mmax for IndraDrive, uncontrolled feed, 3 x AC 400V

Fig.4-86: Motor characteristic curve MSK075D-0450

4.20 MSK075E Technical Data

Description	Symbol	Unit	MSK075E-0200-NN	MSK075E-0300-NN
UL-Files (UL)			-	E163211
Standstill continuous torque 60 K	M_{0_60}	Nm	21.0	
Continuous standstill current 60 K	$I_{0_60(\text{eff})}$	A	10.2	14.2
Standstill continuous torque 100 K	M_{0_100}	Nm	23.0	
Continuous standstill current 100 K	$I_{0_100(\text{eff})}$	A	11.2	15.6
Standstill continuous torque surface	M_{0_S}	Nm	31.5	
Continuous standstill current surface	$I_{0_S(\text{eff})}$	A	15.3	21.3
Maximum torque	M_{max}	Nm	88.0	
Maximum current	$I_{\text{max}(\text{eff})}$	A	45.9	63.9
Torque constant at 20 °C ¹⁾	K_{M_N}	Nm/A	2.26	1.63
Torque constant at 20 °C ²⁾	$K_{\text{EMK}_1,000}$	V/min ⁻¹	139.0	100.0
Winding resistance at 20 °C	R_{12}	Ohm	1.24	0.65
Winding inductivity	L_{12}	mH	8.400	4.460
Discharge capacity of the component	C_{ab}	nF	5.8	6.5
Number of pole pairs	p	-	4	
Rotor moment of inertia	J_{rot}	kg*m ²	0.00613	
Thermal time constant	T_{th}	min	29.0	
Maximum speed	n_{max}	min ⁻¹	3,850	5,200
Sound pressure level	L_P	dB[A]	<75	
Weight ³⁾	m	kg	22.5 (23.6) (24.1)	
Ambient temperature in operation	T_{um}	°C	0 ... 40	
Degree of protection according to IEC60529	---	-	IP65	
Insulation class according to DIN EN 60034-1	---	-	155	

Latest amendment: 2008-04-22

1) 2)

Manufacturing tolerance $\pm 5\%$

3)

(...) values for motors with holding brakes, sorted (holding brake 1, holding brake 2 ...)

Fig.4-87:

MSK - technical data (standard and air-cooling)

Technical Data

Description	Symbol	Unit	MSK075E-0300-FN
UL-Files (UL)			E163211
Standstill continuous torque 60 K	M_{0_60}	Nm	21.0
Continuous standstill current 60 K	$I_{0_60(\text{eff})}$	A	14.2
Standstill continuous torque 100 K	M_{0_100}	Nm	23.0
Continuous standstill current 100 K	$I_{0_100(\text{eff})}$	A	15.6
Standstill continuous torque liquid	M_{0_L}	Nm	39.9
Continuous standstill current liquid	$I_{0_L(\text{eff})}$	A	27.0
Maximum torque	M_{max}	Nm	88.0
Maximum current	$I_{\text{max}(\text{eff})}$	A	63.9
Torque constant at 20 °C ¹⁾	K_{M_N}	Nm/A	1.63
Torque constant at 20 °C ²⁾	$K_{\text{EMK_1,000}}$	V/min ⁻¹	100.0
Winding resistance at 20 °C	R_{12}	Ohm	0.65
Winding inductivity	L_{12}	mH	4.460
Discharge capacity of the component	C_{ab}	nF	6.5
Number of pole pairs	p	-	4
Rotor moment of inertia	J_{rot}	kg*m ²	0.00613
Thermal time constant	T_{th}	min	38.0
Maximum speed	n_{max}	min ⁻¹	5,200
Sound pressure level	L_P	dB[A]	<75
Weight ³⁾	m	kg	22.5 (23.6) (24.1)
Ambient temperature in operation	T_{um}	°C	0 ... 40
Degree of protection according to IEC60529	---	-	IP65
Insulation class according to DIN EN 60034-1	---	-	155
Data liquid cooling			
Power loss to be dissipated	P_V	kW	1.00
Coolant inlet temperature	T_{ein}	°C	10 ... 40
Permitted coolant temperature rise at P_V	ΔT	K	10
Required coolant flow at P_V	Q_{min}	l/min	1.4
Pressure loss at Q_{min}	Δp	bar	0.7
Latest amendment: 2008-06-09			

Description	Symbol	Unit	MSK075E-0300-FN
Maximum permitted inlet pressure	p_{max}	bar	3.0
Volume of coolant duct	V_{kuehl}	l	0.06
Latest amendment: 2008-06-09			

1) 2) Manufacturing tolerance $\pm 5\%$
 3) (...) values for motors with holding brakes, sorted (holding brake 1, holding brake 2 ...)

Fig.4-88: MSK - technical data (standard and liquid cooling)

Description	Symbol	Unit	Holding brake 1	Holding brake 2
Holding torque	M_4	Nm	23.0	30.0
Rated voltage	U_N	V	24	
Rated current	I_N	A	0.79	0.94
Connection time	t_1	ms	130	35
Disconnection time	t_2	ms	180	125
Moment of inertia of the holding brake	J_{rot}	kg*m ²	0.000300	0.001060
Latest amendment: 2007-07-19				

Fig.4-89: Holding brakes - technical data (optional)

Motor characteristic curves

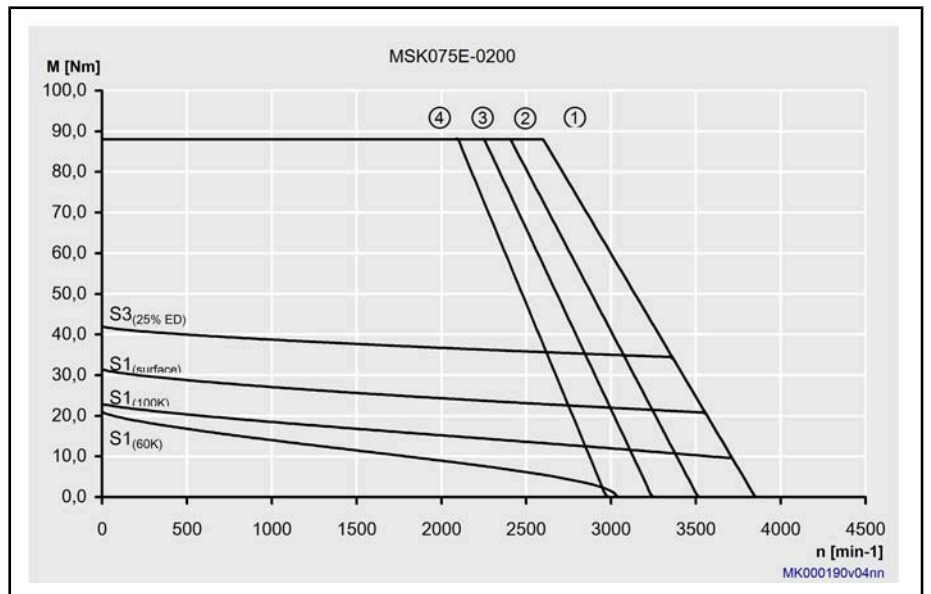

- ① Mmax for IndraDrive, controlled feed, 3 x AC 400V
- ② Mmax for IndraDrive, uncontrolled feed, 3 x AC 480V
- ③ Mmax for IndraDrive, uncontrolled feed, 3 x AC 440V
- ④ Mmax for IndraDrive, uncontrolled feed, 3 x AC 400V

Fig.4-90: Motor characteristic curve MSK075E-0200

Technical Data

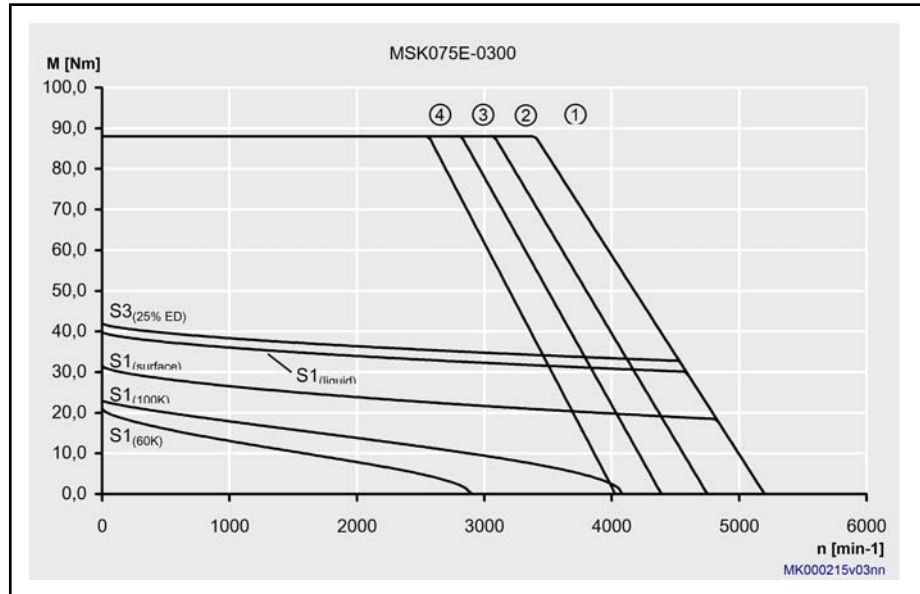

- ① Mmax for IndraDrive, controlled feed, 3 x AC 400V
- ② Mmax for IndraDrive, uncontrolled feed, 3 x AC 480V
- ③ Mmax for IndraDrive, uncontrolled feed, 3 x AC 440V
- ④ Mmax for IndraDrive, uncontrolled feed, 3 x AC 400V

Fig.4-91: Motor characteristic curve MSK075E-300

4.21 MSK076C - Technical Data

Designation	Symbol	Unit	MSK076C-0300-NN	MSK076C-0450-NN
UL Files (UL)			E163211	
Continuous torque at standstill 60 K	M_{0_60}	Nm	12.0	
Continuous current at standstill 60 K	$I_{0_60(rms)}$	A	7.2	12.2
Continuous torque at standstill 100 K	M_{0_100}	Nm	13.5	
Continuous current at standstill 100 K	$I_{0_100(rms)}$	A	8.1	13.7
Continuous torque at standstill surface	M_{0_S}	Nm	18.0	
Continuous current at standstill surface	$I_{0_S(rms)}$	A	10.8	18.3
Maximum torque	M_{max}	Nm	43.5	
Maximum Current	$I_{max(rms)}$	A	32.4	54.9
Torque constant at 20 °C ¹⁾	K_{M_N}	Nm/A	1.84	1.14
Voltage constant at 20 °C ²⁾	K_{EMK_1000}	V/min ⁻¹	113.0	70.5
Winding resistance at 20 °C	R_{12}	ohms	1.85	0.71
Winding inductivity	L_{12}	mH	12.600	4.700
Discharge capacity of the component	C_{dis}	nF	6.5	6.0
Number of pole pairs	p	-	4	
Moment of inertia of the rotor	J_{rot}	kg*m ²	0.00430	
Thermal time constant	T_{th}	min	25.0	
Maximum speed	n_{max}	min ⁻¹	4,700	5,000
Sound pressure level	L_P	dB[A]	< 75	
Weight ³⁾	m	kg	13.8 (14.9)	
Ambient temperature in operation	T_{amb}	°C	0 ... 40	
Type of protection according to IEC 60529	---	-	IP65	
Insulation class according to DIN EN 60034-1	---	-	155	

Latest amendment: 2008-01-29

1) 2)

Manufacturing tolerance ±5 %

3)

(...) Values for motors with holding brake, sorted (holding brake 1, holding brake 2 ...)

Fig.4-92:

MSK - Technical data (standard and air cooling)

Technical Data

Designation	Symbol	Unit	Holding brake 1
Holding torque	M_4	Nm	11.0
Rated voltage	U_N	V	24
Rated current	I_N	A	0.71
Connection time	t_1	ms	13
Disconnection time	t_2	ms	30
Moment of inertia of the holding brake	J_{rot}	kg*m ²	0.000360

Latest amendment: 2002-03-01

Fig.4-93: Holding brakes MSK076 - Technical data (optional)

Characteristic Motor Curves

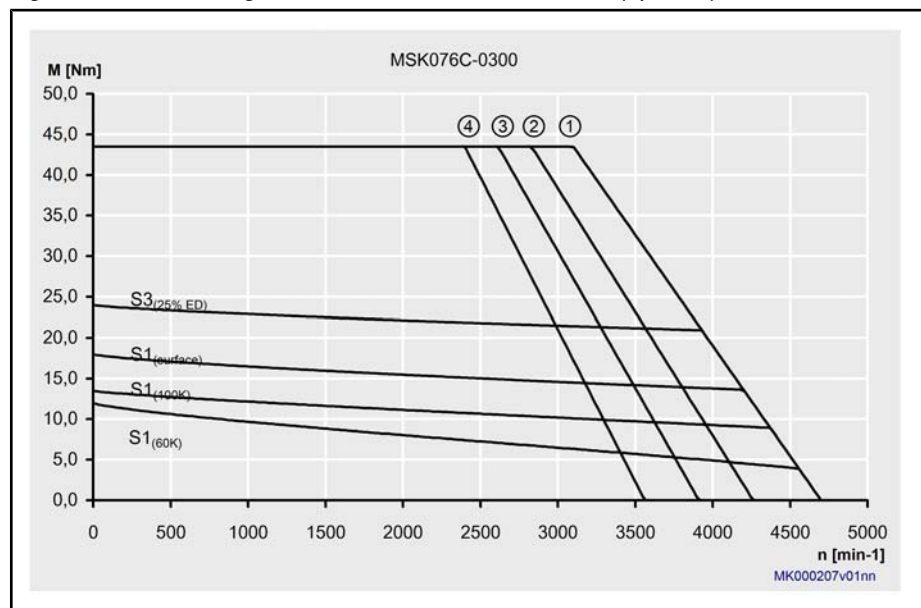

- ① Mmax for IndraDrive, controlled feed, 3 x AC 400 V
- ② Mmax for IndraDrive, uncontrolled feed, 3 x AC 480 V
- ③ Mmax for IndraDrive, uncontrolled feed, 3 x AC 440 V
- ④ Mmax for IndraDrive, uncontrolled feed, 3 x AC 400 V

Fig.4-94: Characteristic curves of a MSK076C-0300 motor

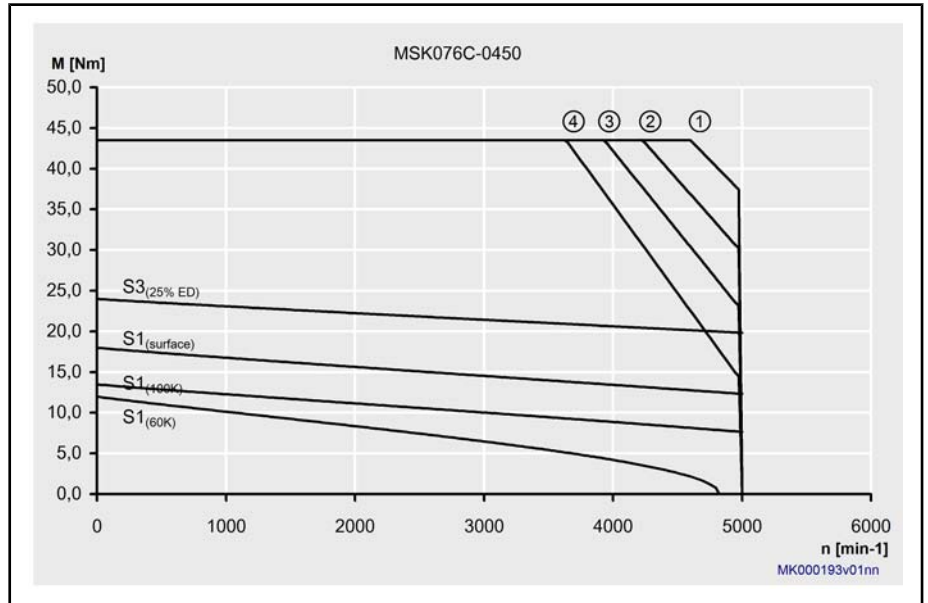

- ① Mmax for IndraDrive, controlled feed, 3 x AC 400 V
- ② Mmax for IndraDrive, uncontrolled feed, 3 x AC 480 V
- ③ Mmax for IndraDrive, uncontrolled feed, 3 x AC 440 V
- ④ Mmax for IndraDrive, uncontrolled feed, 3 x AC 400 V

Fig. 4-95: Characteristic curves of a MSK076C-0450 motor

Technical Data

4.22 MSK100A - Technical Data

Data Sheet - Motor

Designation	Symbol	Unit	MSK100A-0200-NN	MSK100A-0300-NN	MSK100A-0450-NN
UL Files (UL)			E163211		
Continuous torque at standstill 60 K	M_{0_60}	Nm	15.0		
Continuous current at standstill 60 K	$I_{0_60(rms)}$	A	9.2	10.2	12.0
Continuous torque at standstill 100 K	M_{0_100}	Nm	17.0		
Continuous current at standstill 100 K	$I_{0_100(rms)}$	A	10.4	11.6	13.6
Continuous torque at standstill surface	M_{0_S}	Nm	22.5		
Continuous current at standstill surface	$I_{0_S(rms)}$	A	13.8	15.3	18.0
Maximum torque	M_{max}	Nm	54.0		
Maximum Current	$I_{max(rms)}$	A	41.4	45.9	54.0
Torque constant at 20 °C ¹⁾	K_{M_N}	Nm/A	1.89	1.70	1.45
Voltage constant at 20 °C ²⁾	K_{EMK_1000}	V/min ⁻¹	116.4	104.5	89.4
Winding resistance at 20 °C	R_{12}	ohms	1.45	1.10	0.81
Winding inductivity	L_{12}	mH	13.900	11.200	7.800
Discharge capacity of the component	C_{dis}	nF	4.8	4.6	4.9
Number of pole pairs	p	-	4		
Moment of inertia of the rotor	J_{rot}	kg*m ²	0.01100		
Thermal time constant	T_{th}	min	48.0	39.0	
Maximum speed	n_{max}	min ⁻¹	4,400	5,200	6,000
Sound pressure level	L_P			<75	
Weight ³⁾	m	kg	23.0 (24.1) (25.4)		
Ambient temperature in operation	T_{amb}	°C	0 ... 40		
Type of protection according to IEC 60529	---	-	IP65		
Insulation class according to DIN EN 60034-1	---	-	155		

Latest amendment: 2008-02-13

1) 2)

Manufacturing tolerance $\pm 5\%$

3)

(...) Values for motors with holding brake, sorted (holding brake 1, holding brake 2 ...)

Fig.4-96:

MSK - Technical data (standard and air cooling)

Designation	Symbol	Unit	Holding brake 1
Holding torque	M_4	Nm	32.0
Rated voltage	U_N	V	24
Rated current	I_N	A	0.93
Connection time	t_1	ms	15
Disconnection time	t_2	ms	115
Moment of inertia of the holding brake	J_{rot}	kg*m ²	0.001242

Latest amendment: 2002-11-08

Fig.4-97: Holding brakes - Technical data (optional)

Motor Characteristic Curves

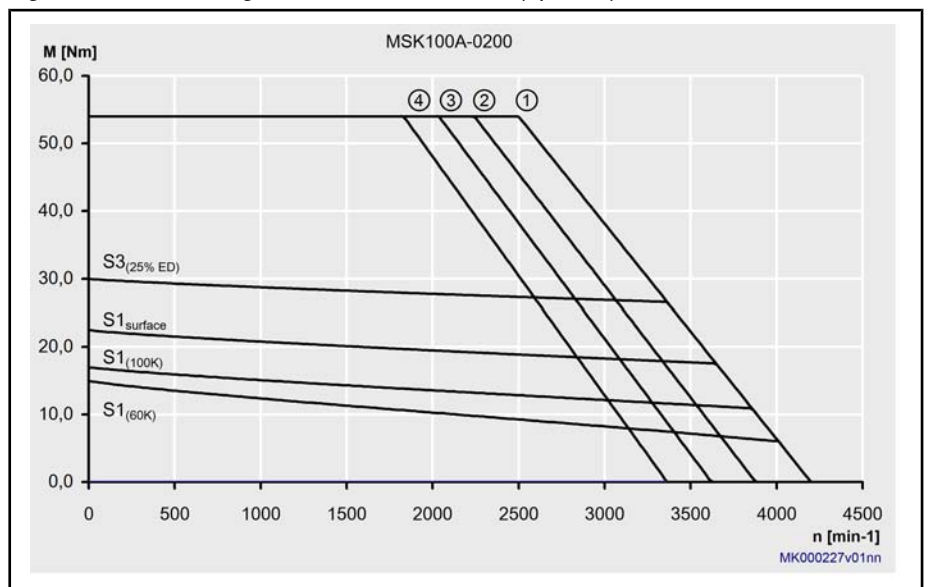

- ① Mmax for IndraDrive, controlled feed, 3 x AC 400 V
- ② Mmax for IndraDrive, uncontrolled feed, 3 x AC 480 V
- ③ Mmax for IndraDrive, uncontrolled feed, 3 x AC 440 V
- ④ Mmax for IndraDrive, uncontrolled feed, 3 x AC 400 V

Fig.4-98: Characteristic curve of a MSK100A-0200 motor

Technical Data

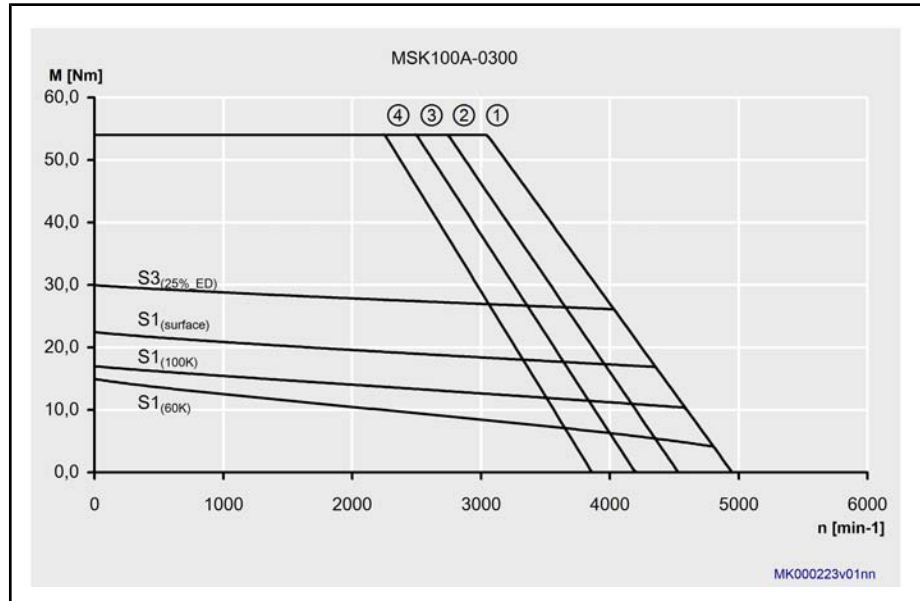

- ① Mmax for IndraDrive, controlled feed, 3 x AC 400 V
- ② Mmax for IndraDrive, uncontrolled feed, 3 x AC 480 V
- ③ Mmax for IndraDrive, uncontrolled feed, 3 x AC 440 V
- ④ Mmax for IndraDrive, uncontrolled feed, 3 x AC 400 V

Fig.4-99: Characteristic curve of a MSK100A-0300 motor

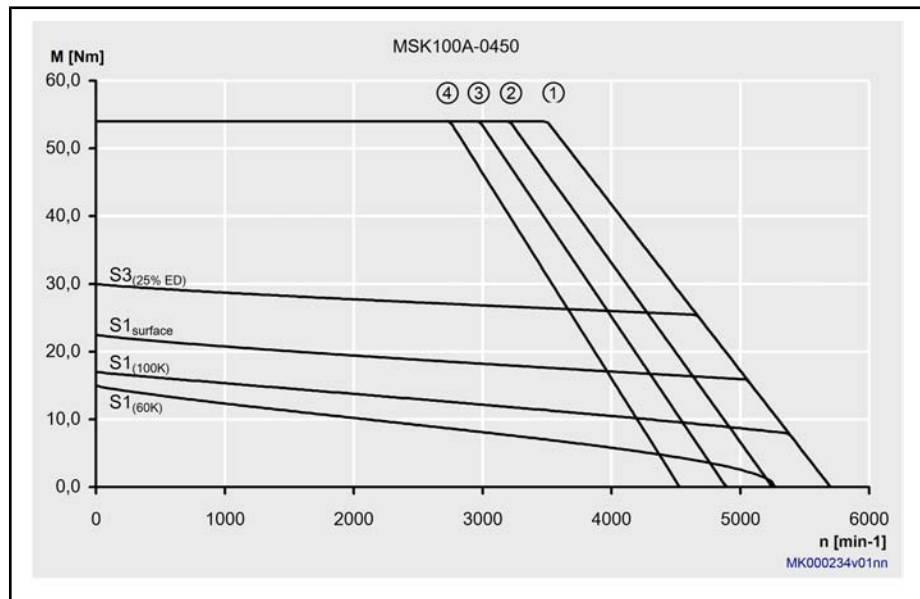

- ① Mmax for IndraDrive, controlled feed, 3 x AC 400 V
- ② Mmax for IndraDrive, uncontrolled feed, 3 x AC 480 V
- ③ Mmax for IndraDrive, uncontrolled feed, 3 x AC 440 V
- ④ Mmax for IndraDrive, uncontrolled feed, 3 x AC 400 V

Fig.4-100: Characteristic curve of a MSK100A-0450 motor

4.23 MSK100B - Technical Data

Designation	Symbol	Unit	MSK100B-020 0-NN	MSK100B-030 0-NN	MSK100B-040 0-NN	MSK100B-045 0-NN
UL Files (UL)			E163211			
Continuous torque at standstill 60 K	M_{0_60}	Nm	28.0			
Continuous current at standstill 60 K	$I_{0_60(rms)}$	A	14.7	17.4	23.7	28.5
Continuous torque at standstill 100 K	M_{0_100}	Nm	33.0			
Continuous current at standstill 100 K	$I_{0_100(rms)}$	A	17.3	20.5	30.8	33.6
Continuous torque at standstill surface	M_{0_S}	Nm	42.0			
Continuous current at standstill surface	$I_{0_S(rms)}$	A	22.1	26.1	35.6	42.8
Maximum torque	M_{max}	Nm	102.0			
Maximum Current	$I_{max(rms)}$	A	66.2	78.3	106.7	110.7
Torque constant at 20 °C ¹⁾	K_{M_N}	Nm/A	2.10	1.77	1.30	1.14
Voltage constant at 20 °C ²⁾	K_{EMK_1000}	V/min ⁻¹	129.5	108.5	80.0	70.0
Winding resistance at 20 °C	R_{12}	ohms	0.58	0.43	0.23	0.17
Winding inductivity	L_{12}	mH	7.600	5.500	3.100	2.200
Discharge capacity of the component	C_{dis}	nF	10.3	9.3	10.3	
Number of pole pairs	p	-	4			
Moment of inertia of the rotor	J_{rot}	kg*m ²	0.01920			
Thermal time constant	T_{th}	min	40.0			
Maximum speed	n_{max}	min ⁻¹	4,100	4,500		
Sound pressure level	L_P	dB[A]	<75			
Weight ³⁾	m	kg	34.0 (37.8)			
Ambient temperature in operation	T_{amb}	°C	0 ... 40			
Type of protection according to IEC 60529	---	-	IP65			
Insulation class according to DIN EN 60034-1	---	-	155			

Latest amendment: 2008-02-13

1) 2)

Manufacturing tolerance ±5 %

3)

(...) Values for motors with holding brake, sorted (holding brake 1, holding brake 2 ...)

Fig.4-101:

Technical data

Technical Data

Designation	Symbol	Unit	Holding brake 1	Holding brake 2
Holding torque	M_4	Nm	32.0	70.0
Rated voltage	U_N	V	24	
Rated current	I_N	A	0.93	1.29
Connection time	t_1	ms	15	53
Disconnection time	t_2	ms	115	97
Moment of inertia of the holding brake	J_{rot}	kg*m ²	0.001242	0.003000

Latest amendment: 2002-11-08

Fig.4-102: Holding brakes - Technical data (optional)

Characteristic Motor Curves

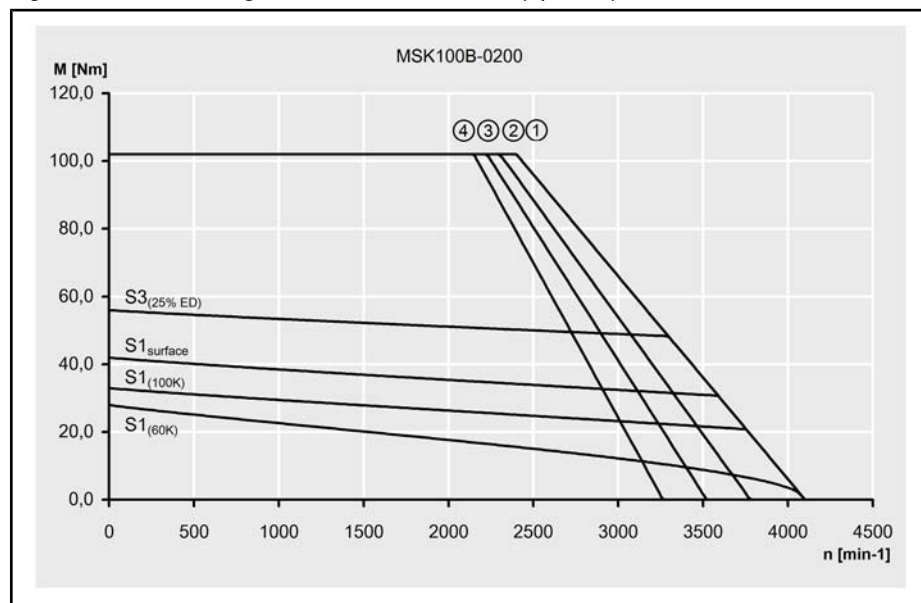

- ① Mmax for IndraDrive, controlled feed, 3 x AC 400 V
- ② Mmax for IndraDrive, uncontrolled feed, 3 x AC 480 V
- ③ Mmax for IndraDrive, uncontrolled feed, 3 x AC 440 V
- ④ Mmax for IndraDrive, uncontrolled feed, 3 x AC 400 V

Fig.4-103: Characteristic curve of a MSK100B-0200 motor

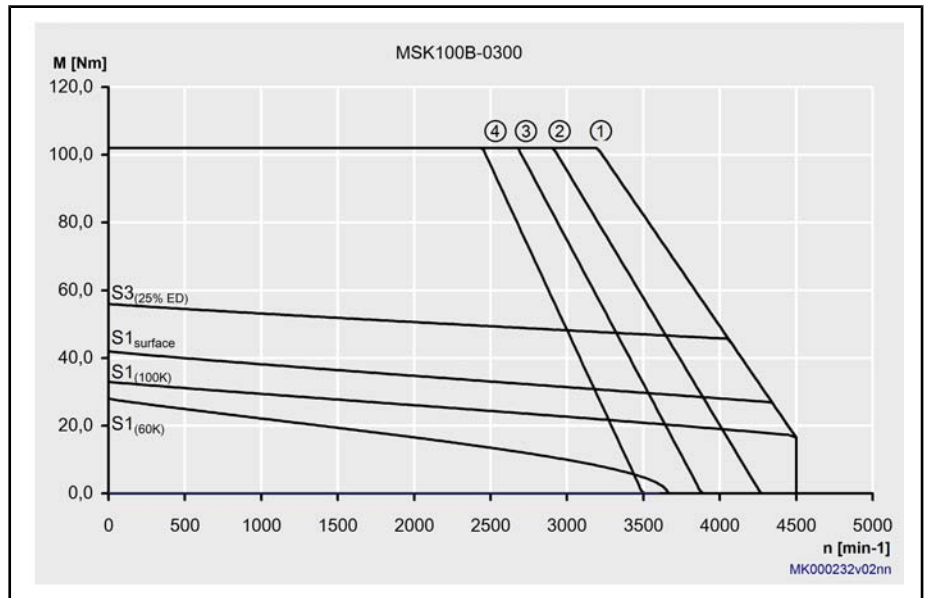

- ① Mmax for IndraDrive, controlled feed, 3 x AC 400 V
- ② Mmax for IndraDrive, uncontrolled feed, 3 x AC 480 V
- ③ Mmax for IndraDrive, uncontrolled feed, 3 x AC 440 V
- ④ Mmax for IndraDrive, uncontrolled feed, 3 x AC 400 V

Fig. 4-104: Characteristic curve of a MSK100B-0300 motor

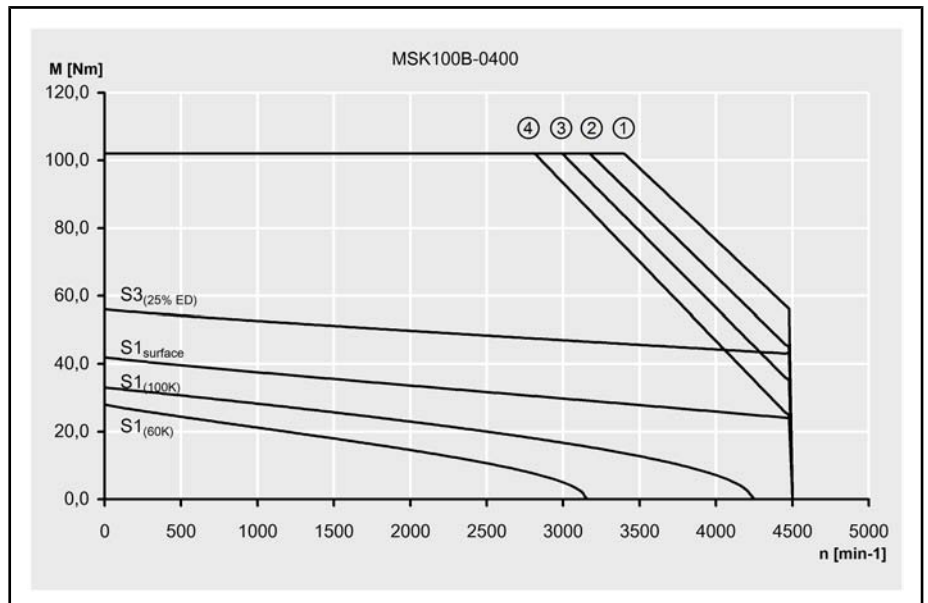

- ① Mmax for IndraDrive, controlled feed, 3 x AC 400 V
- ② Mmax for IndraDrive, uncontrolled feed, 3 x AC 480 V
- ③ Mmax for IndraDrive, uncontrolled feed, 3 x AC 440 V
- ④ Mmax for IndraDrive, uncontrolled feed, 3 x AC 400 V

Fig. 4-105: Characteristic curve of a MSK100B-0400 motor

Technical Data

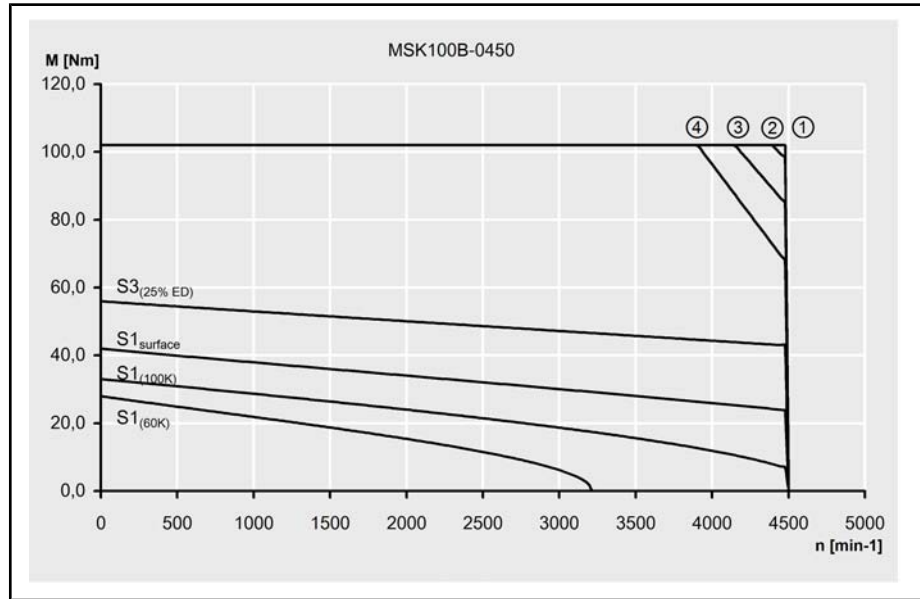

- ① Mmax for IndraDrive, controlled feed, 3 x AC 400 V
- ② Mmax for IndraDrive, uncontrolled feed, 3 x AC 480 V
- ③ Mmax for IndraDrive, uncontrolled feed, 3 x AC 440 V
- ④ Mmax for IndraDrive, uncontrolled feed, 3 x AC 400 V

Fig.4-106: Characteristic curve of a MSK100B-0450 motor

4.24 MSK100C - Technical Data

Designation	Symbol	Unit	MSK100C-0200-NN	MSK100C-0300-NN	MSK100C-0450-NN
UL Files (UL)			E163211		
Continuous torque at standstill 60 K	M_{0_60}	Nm	38.0		
Continuous current at standstill 60 K	$I_{0_60(rms)}$	A	17.7	21.6	35.4
Continuous torque at standstill 100 K	M_{0_100}	Nm	43.5		
Continuous current at standstill 100 K	$I_{0_100(rms)}$	A	20.3	27.0	43.5
Continuous torque at standstill surface	M_{0_S}	Nm	57.0		
Continuous current at standstill surface	$I_{0_S(rms)}$	A	26.6	32.4	52.9
Maximum torque	M_{max}	Nm	148.0		
Maximum Current	$I_{max(rms)}$	A	79.7	97.2	159.3
Torque constant at 20 °C ¹⁾	K_{M_N}	Nm/A	2.37	1.94	1.18
Voltage constant at 20 °C ²⁾	K_{EMK_1000}	V/min ⁻¹	145.5	119.1	72.7
Winding resistance at 20 °C	R_{12}	ohms	0.46	0.30	0.12
Winding inductivity	L_{12}	mH	6.700	4.200	1.600
Discharge capacity of the component	C_{dis}	nF	12.8	14.3	13.2
Number of pole pairs	p	-	4		
Moment of inertia of the rotor	J_{rot}	kg*m ²	0.02730		
Thermal time constant	T_{th}	min	90.0		
Maximum speed	n_{max}	min ⁻¹	3,500	4,500	4,000
Sound pressure level	L_P	dB[A]	<75		
Weight ³⁾	m	kg	45.1 (50.0)		
Ambient temperature in operation	T_{amb}	°C	0 ... 40		
Type of protection according to IEC 60529	---	-	IP65		
Insulation class according to DIN EN 60034-1	---	-	155		

Latest amendment: 2008-01-29

1) 2)

Manufacturing tolerance ±5 %

3)

(...) Values for motors with holding brake, sorted (holding brake 1, holding brake 2 ...)

Fig.4-107:

Technical data

Technical Data

Designation	Symbol	Unit	Holding brake 2
Holding torque	M_4	Nm	70.0
Rated voltage	U_N	V	24
Rated current	I_N	A	1.29
Connection time	t_1	ms	53
Disconnection time	t_2	ms	97
Moment of inertia of the holding brake	J_{rot}	kg*m ²	0.003000

Latest amendment: 2000-08-02

Fig.4-108: Holding brakes - Technical data (optional)

Characteristic Motor Curves

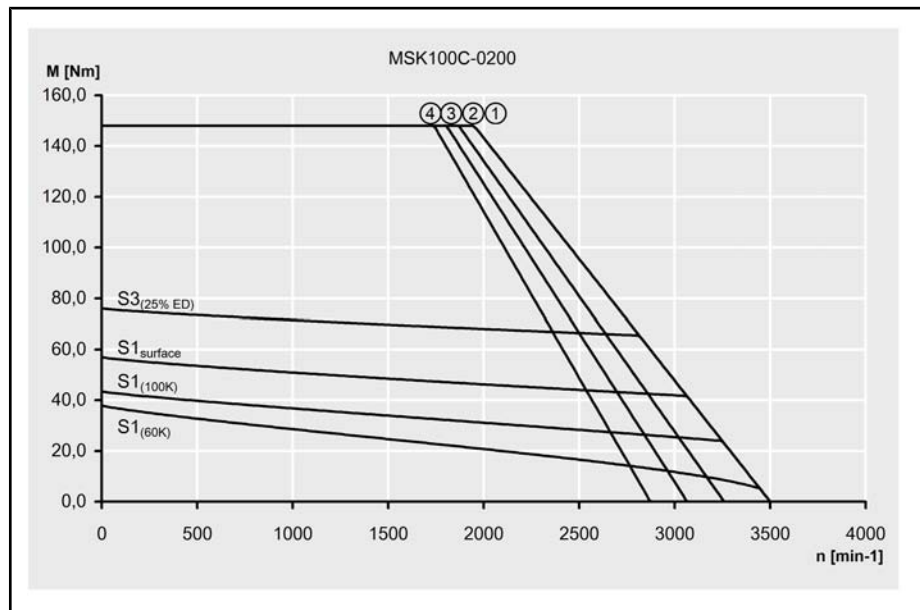

- ① Mmax for IndraDrive, controlled feed, 3 x AC 400 V
- ② Mmax for IndraDrive, uncontrolled feed, 3 x AC 480 V
- ③ Mmax for IndraDrive, uncontrolled feed, 3 x AC 440 V
- ④ Mmax for IndraDrive, uncontrolled feed, 3 x AC 400 V

Fig.4-109: Characteristic curve of a MSK100C-0200 motor

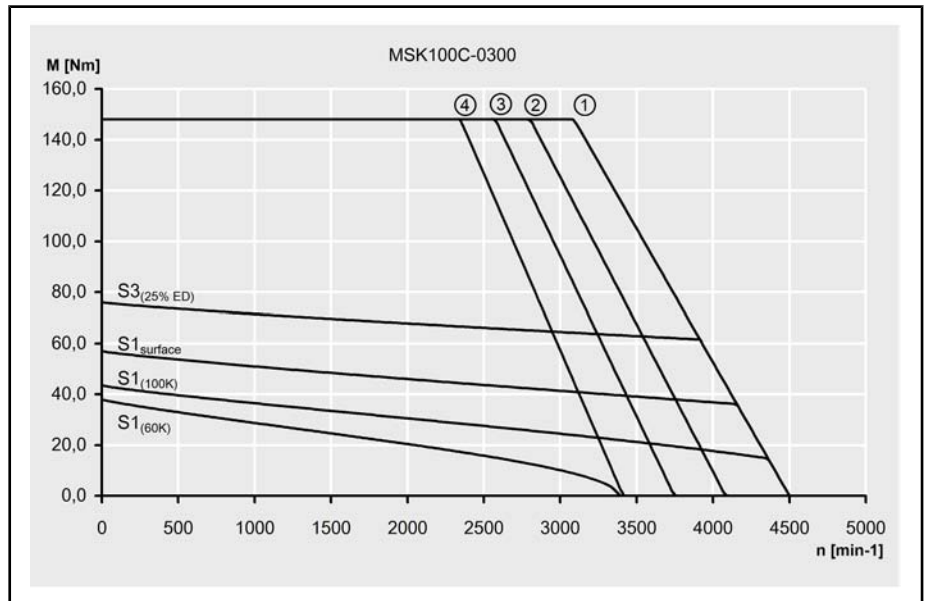

- ① Mmax for IndraDrive, controlled feed, 3 x AC 400 V
- ② Mmax for IndraDrive, uncontrolled feed, 3 x AC 480 V
- ③ Mmax for IndraDrive, uncontrolled feed, 3 x AC 440 V
- ④ Mmax for IndraDrive, uncontrolled feed, 3 x AC 400 V

Fig.4-110: Characteristic curve of a MSK100C-0300 motor

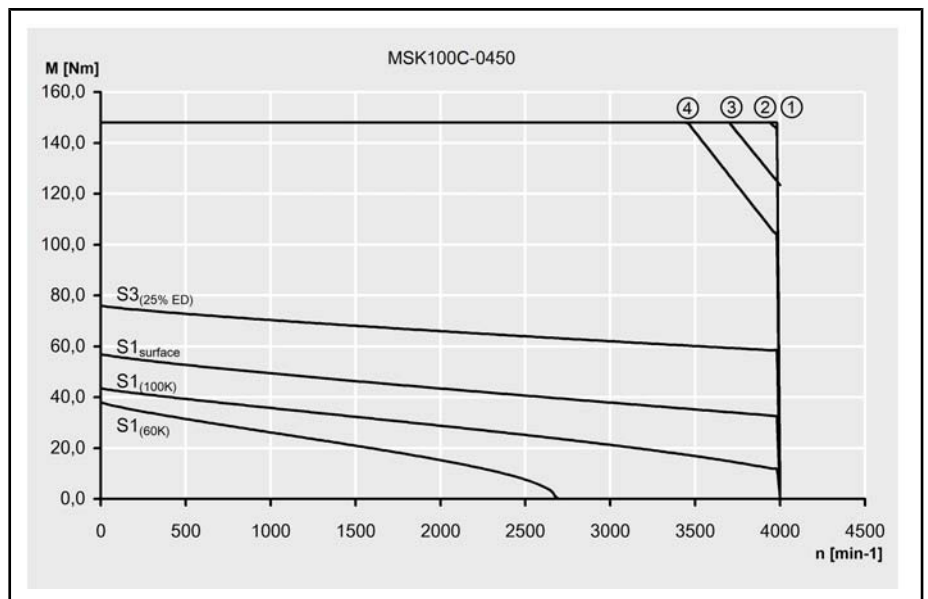

- ① Mmax for IndraDrive, controlled feed, 3 x AC 400 V
- ② Mmax for IndraDrive, uncontrolled feed, 3 x AC 480 V
- ③ Mmax for IndraDrive, uncontrolled feed, 3 x AC 440 V
- ④ Mmax for IndraDrive, uncontrolled feed, 3 x AC 400 V

Fig.4-111: Characteristic curve of a MSK100C-0450 motor

Technical Data

4.25 MSK100D - Technical Data

Designation	Symbol	Unit	MSK100D-0200-NN	MSK100D-0300-NN	MSK100D-0350-NN
UL Files (UL)			E163211		
Continuous torque at standstill 60 K	M_{0_60}	Nm	48.0		
Continuous current at standstill 60 K	$I_{0_60(rms)}$	A	13.0	20.7	29.9
Continuous torque at standstill 100 K	M_{0_100}	Nm	57.0		
Continuous current at standstill 100 K	$I_{0_100(rms)}$	A	15.4	24.8	35.5
Continuous torque at standstill surface	M_{0_S}	Nm	72.0		
Continuous current at standstill surface	$I_{0_S(rms)}$	A	19.5	31.1	44.9
Maximum torque	M_{max}	Nm	187.0		185.0
Maximum Current	$I_{max(rms)}$	A	58.5	93.2	135.0
Torque constant at 20 °C ¹⁾	$K_{M,N}$	Nm/A	4.28	2.55	1.86
Voltage constant at 20 °C ²⁾	K_{EMK_1000}	V/min ⁻¹	263.5	157.0	114.5
Winding resistance at 20 °C	R_{12}	ohms	0.97	0.35	0.20
Winding inductivity	L_{12}	mH	14.800	5.650	3.200
Discharge capacity of the component	C_{dis}	nF	17.6	16.0	18.0
Number of pole pairs	p	-	4		
Moment of inertia of the rotor	J_{rot}	kg*m ²	0.03500		
Thermal time constant	T_{th}	min	90.0		
Maximum speed	n_{max}	min ⁻¹	2,000	3,000	
Sound pressure level	L_P	dB[A]	<75		
Weight ³⁾	m	kg	56.0 (59.5)		
Ambient temperature in operation	T_{amb}	°C	0 ... 40		
Type of protection according to IEC 60529	---	-	IP65		
Insulation class according to DIN EN 60034-1	---	-	155		

Latest amendment: 2008-05-27

- 1) 2) Manufacturing tolerance $\pm 5\%$
3) (...) Values for motors with holding brake, sorted (holding brake 1, holding brake 2 ...)

Fig.4-112: technical data

Designation	Symbol	Unit	Holding brake 2
Holding torque	M_4	Nm	70.0
Rated voltage	U_N	V	24
Rated current	I_N	A	1.29
Connection time	t_1	ms	53
Disconnection time	t_2	ms	97
Moment of inertia of the holding brake	J_{rot}	kg*m ²	0.003000

Latest amendment: 2000-08-02

Fig.4-113: Holding brakes - Technical data (optional)

Motor Characteristic Curves

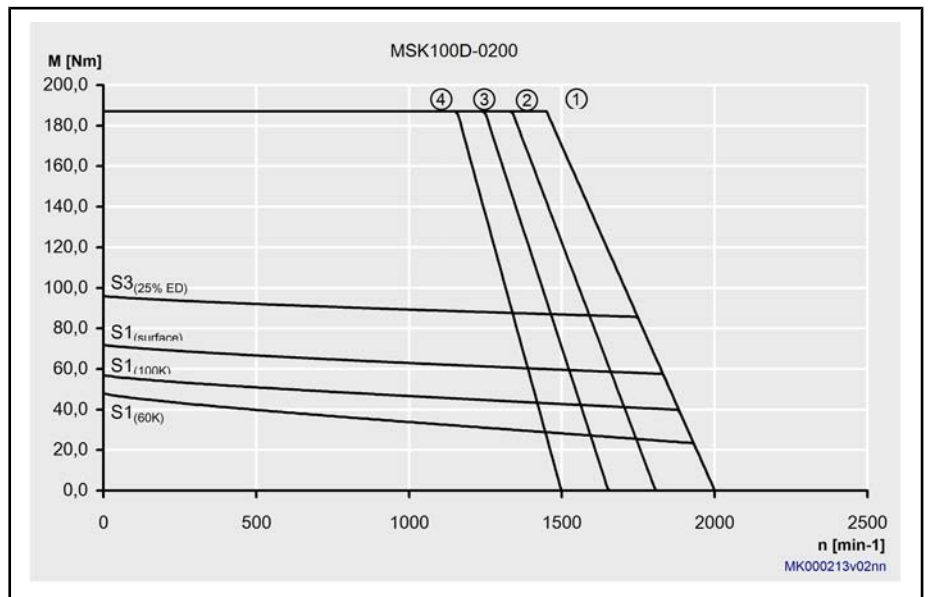

- ① Mmax for IndraDrive, controlled feed, 3 x AC 400 V
- ② Mmax for IndraDrive, uncontrolled feed, 3 x AC 480 V
- ③ Mmax for IndraDrive, uncontrolled feed, 3 x AC 440 V
- ④ Mmax for IndraDrive, uncontrolled feed, 3 x AC 400 V

Fig.4-114: Characteristic curve of a MSK100D-0200 motor

Technical Data

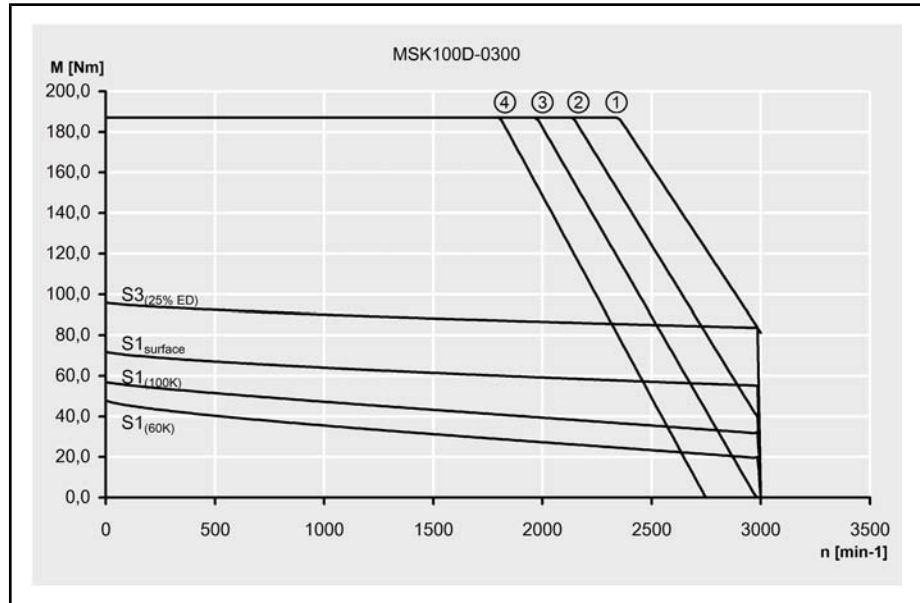

- ① Mmax for IndraDrive, controlled feed, 3 x AC 400 V
- ② Mmax for IndraDrive, uncontrolled feed, 3 x AC 480 V
- ③ Mmax for IndraDrive, uncontrolled feed, 3 x AC 440 V
- ④ Mmax for IndraDrive, uncontrolled feed, 3 x AC 400 V

Fig.4-115: Characteristic curve of a MSK100D-0300 motor

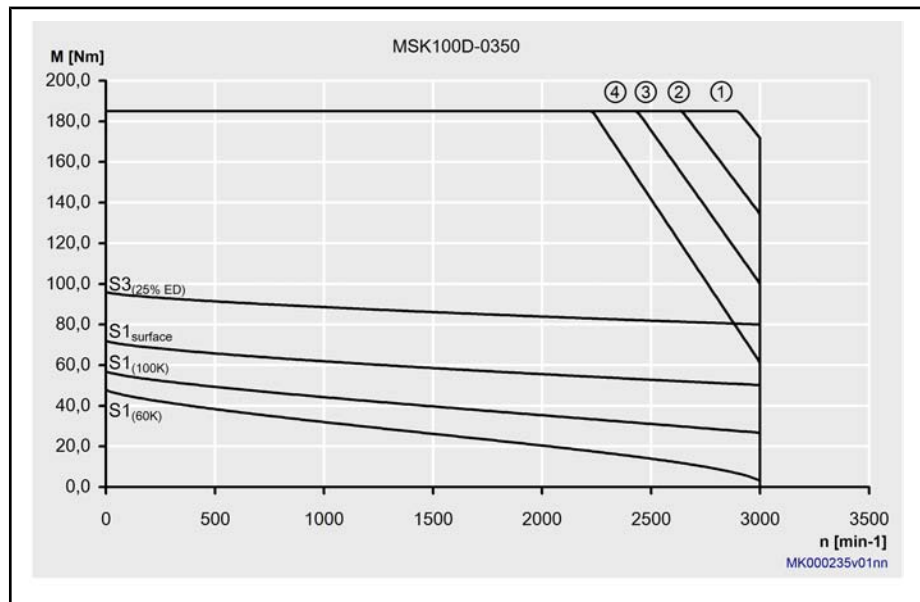

- ① Mmax for IndraDrive, controlled feed, 3 x AC 400 V
- ② Mmax for IndraDrive, uncontrolled feed, 3 x AC 480 V
- ③ Mmax for IndraDrive, uncontrolled feed, 3 x AC 440 V
- ④ Mmax for IndraDrive, uncontrolled feed, 3 x AC 400 V

Fig.4-116: Characteristic curve of a MSK100D-0350 motor

4.26 MSK101C - Technical Data

Designation	Symbol	Unit	MSK101C-0200-NN	MSK101C-0300-NN	MSK101C-0450-NN
UL Files (UL)			E163211		
Continuous torque at standstill 60 K	M_{0_60}	Nm	32.0		
Continuous current at standstill 60 K	$I_{0_60(rms)}$	A	14.9	18.7	25.1
Continuous torque at standstill 100 K	M_{0_100}	Nm	36.5		
Continuous current at standstill 100 K	$I_{0_100(rms)}$	A	17.0	21.3	28.6
Continuous torque at standstill surface	M_{0_S}	Nm	48.0		
Continuous current at standstill surface	$I_{0_S(rms)}$	A	22.4	28.1	37.7
Maximum torque	M_{max}	Nm	110.0		
Maximum Current	$I_{max(rms)}$	A	67.1	84.2	113.0
Torque constant at 20 °C ¹⁾	K_{M_N}	Nm/A	2.37	1.88	1.40
Voltage constant at 20 °C ²⁾	K_{EMK_1000}	V/min ⁻¹	146.0	115.7	86.3
Winding resistance at 20 °C	R_{12}	ohms	0.68	0.45	0.23
Winding inductivity	L_{12}	mH	9.700	6.000	3.300
Discharge capacity of the component	C_{dis}	nF	6.2		6.8
Number of pole pairs	p	-	4		
Moment of inertia of the rotor	J_{rot}	kg*m ²	0.00650		
Thermal time constant	T_{th}	min	36.0	38.0	36.0
Maximum speed	n_{max}	min ⁻¹	3,300	4,500	5,800
Sound pressure level	L_P	dB[A]	<75		
Weight ³⁾	m	kg	28.3 (32.1)		
Ambient temperature in operation	T_{amb}	°C	0 ... 40		
Type of protection according to IEC 60529	---	-	IP65		
Insulation class according to DIN EN 60034-1	---	-	155		

Latest amendment: 2008-06-09

1) 2)

Manufacturing tolerance ±5 %

3)

(...) Values for motors with holding brake, sorted (holding brake 1, holding brake 2 ...)

Fig.4-117:

MSK - Technical data (standard and air cooling)

Technical Data

Designation	Symbol	Unit	MSK101C-0200-FN	MSK101C-0300-FN	MSK101C-0450-FN
UL Files (UL)			E163211		
Continuous torque at standstill 60 K	M_{0_60}	Nm	32.0		
Continuous current at standstill 60 K	$I_{0_60(rms)}$	A	14.9	18.7	25.1
Continuous torque at standstill 100 K	M_{0_100}	Nm	36.5		
Continuous current at standstill 100 K	$I_{0_100(rms)}$	A	17.0	21.3	37.7
Standstill continuous torque liquid	M_{0_L}	Nm	60.8		
Continuous standstill current liquid	$I_{0_L(rms)}$	A	28.3	35.3	47.7
Maximum torque	M_{max}	Nm	110.0		
Maximum Current	$I_{max(rms)}$	A	67.1	84.2	113.0
Torque constant at 20 °C ¹⁾	K_{M_N}	Nm/A	2.37	1.88	1.40
Voltage constant at 20 °C ²⁾	K_{EMK_1000}	V/min ⁻¹	146.0	115.7	86.3
Winding resistance at 20 °C	R_{12}	ohms	0.68	0.45	0.23
Winding inductivity	L_{12}	mH	9.700	6.000	3.300
Discharge capacity of the component	C_{dis}	nF	6.2		6.8
Number of pole pairs	p	-	4		
Moment of inertia of the rotor	J_{rot}	kg*m ²	0.00650		
Thermal time constant	T_{th}			38.0	
Maximum speed	n_{max}	min ⁻¹	3,300	4,500	5,800
Sound pressure level	L_P	dB[A]	<75		
Weight ³⁾	m	kg	28.3 (32.1)		
Ambient temperature in operation	T_{amb}	°C	0 ... 40		
Type of protection according to IEC 60529	---	-	IP65		
Insulation class according to DIN EN 60034-1	---	-	155		
Data liquid cooling					
Power loss to be dissipated	P_V	kW	1.10		
Coolant inlet temperature	T_{ein}	°C	10 ... 40		
Permitted coolant temperature rise at P_V	ΔT	K	10		

Latest amendment: 2008-06-09

Designation	Symbol	Unit	MSK101C-0200-FN	MSK101C-0300-FN	MSK101C-0450-FN
Required coolant flow at Pv	Q_{min}	l/min	1.5		
Pressure loss at Q_{min}	Δp	bar	0.8		
Maximum permitted inlet pressure	p_{max}	bar	3.0		
Volume of coolant duct	V_{kuehl}	l	0.09		
Latest amendment: 2008-06-09					

- 1) 2) Manufacturing tolerance $\pm 5\%$
- 3) (...) Values for motors with holding brake, sorted (holding brake 1, holding brake 2 ...)

Fig.4-118: MSK - Technical data (standard and liquid cooling)

Designation	Symbol	Unit	Holding brake 2	Holding brake 3
Holding torque	M_4	Nm	70.0	120.0
Rated voltage	U_N	V	24	
Rated current	I_N	A	1.29	1.46
Connection time	t_1	ms	53	80
Disconnection time	t_2	ms	97	150
Moment of inertia of the holding brake	J_{rot}	kg*m ²	0.003000	0.005750
Latest amendment: 2005-05-17				

Fig.4-119: Holding brakes - Technical data (optional)

Characteristic Motor Curves

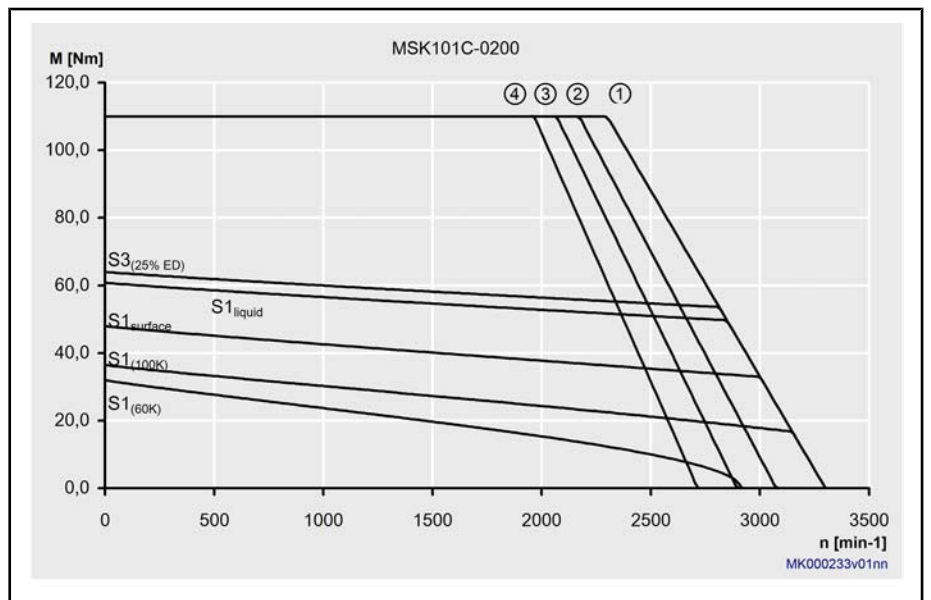

- ① Mmax for IndraDrive, controlled feed, 3 x AC 400 V
- ② Mmax for IndraDrive, uncontrolled feed, 3 x AC 480 V
- ③ Mmax for IndraDrive, uncontrolled feed, 3 x AC 440 V
- ④ Mmax for IndraDrive, uncontrolled feed, 3 x AC 400 V

Fig.4-120: Characteristic curve of a MSK101C-0200 motor

Technical Data

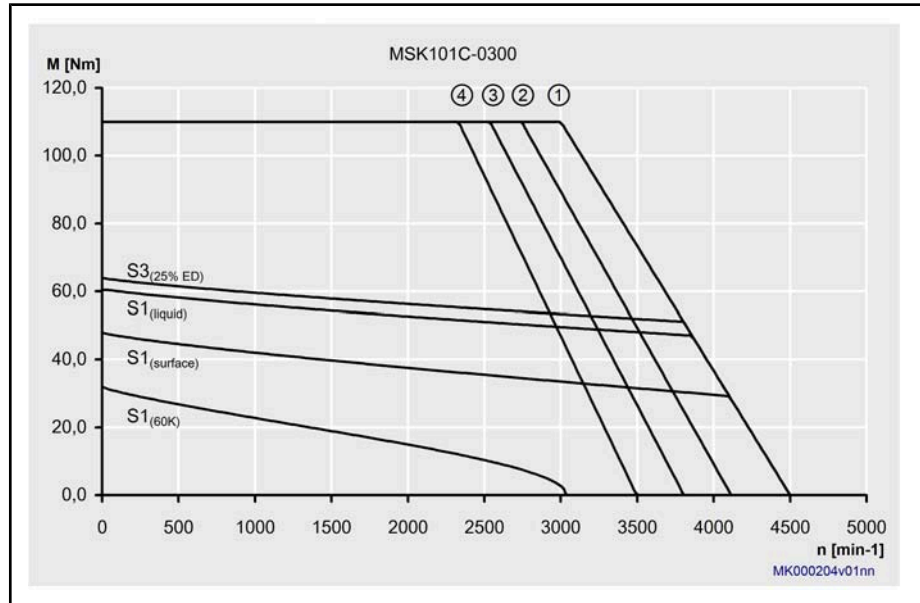

- ① Mmax for IndraDrive, controlled feed, 3 x AC 400 V
- ② Mmax for IndraDrive, uncontrolled feed, 3 x AC 480 V
- ③ Mmax for IndraDrive, uncontrolled feed, 3 x AC 440 V
- ④ Mmax for IndraDrive, uncontrolled feed, 3 x AC 400 V

Fig.4-121: Characteristic curve of a MSK101C-300 motor

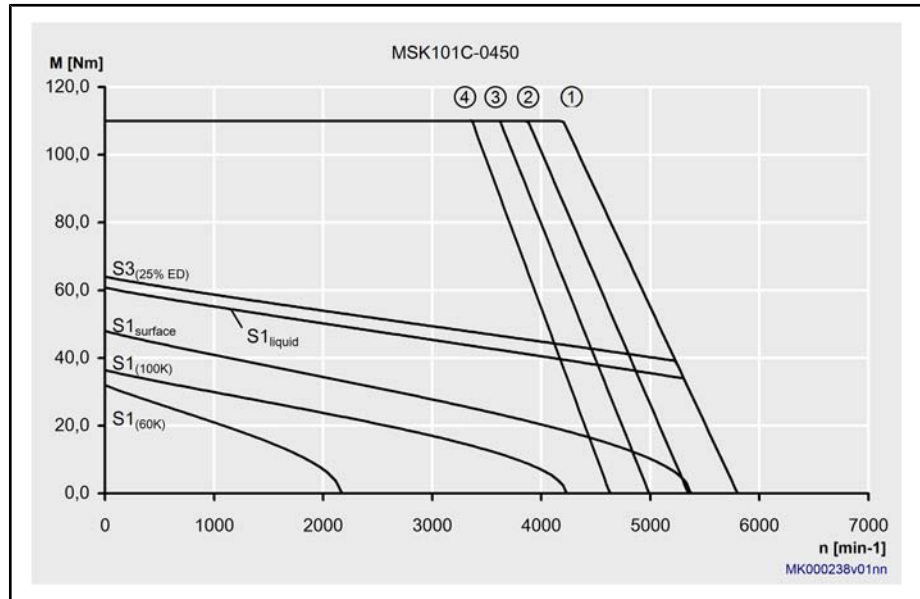

- ① Mmax for IndraDrive, controlled feed, 3 x AC 400 V
- ② Mmax for IndraDrive, uncontrolled feed, 3 x AC 480 V
- ③ Mmax for IndraDrive, uncontrolled feed, 3 x AC 440 V
- ④ Mmax for IndraDrive, uncontrolled feed, 3 x AC 400 V

Fig.4-122: Characteristic curve of a MSK101C-0450 motor

4.27 MSK101D - Technical Data

Designation	Symbol	Unit	MSK101D-0200-NN	MSK101D-0300-NN	MSK101D-0450-NN
UL Files (UL)			E163211		
Continuous torque at standstill 60 K	M_{0_60}	Nm	50.0		
Continuous current at standstill 60 K	$I_{0_60(rms)}$	A	22.2	30.6	41.7
Continuous torque at standstill 100 K	M_{0_100}	Nm	57.0		
Continuous current at standstill 100 K	$I_{0_100(rms)}$	A	26.8	34.9	50.6
Continuous torque at standstill, surface	M_{0_S}	Nm	75.0		
Continuous current at standstill, surface	$I_{0_S(rms)}$	A	33.3	45.9	66.0
Maximum torque	M_{max}	Nm	160.0		
Maximum Current	$I_{max(rms)}$	A	99.9	137.7	187.7
Torque constant at 20 °C ¹⁾	K_{M_N}	Nm/A	2.48	1.80	1.32
Voltage constant at 20 °C ²⁾	K_{EMK_1000}	V/min ⁻¹	152.0	113.0	81.0
Winding resistance at 20 °C	R_{12}	ohms	0.35	0.19	0.10
Winding inductivity	L_{12}	mH	6.000	3.200	1.700
Discharge capacity of the component	C_{dis}	nF	13.2	9.1	13.2
Number of pole pairs	p	-	4		
Moment of inertia of the rotor	J_{rot}	kg*m ²	0.00932		
Thermal time constant	T_{th}	min	100.0		
Maximum speed	n_{max}	min ⁻¹	3,400	4,600	6,000
Sound pressure level	L_P	dB[A]	<75		
Weight ³⁾	m	kg	40.0 (43.8) (46.2)		
Ambient temperature in operation	T_{amb}	°C	0 ... 40		
Type of protection according to IEC 60529	---	-	IP65		
Insulation class according to DIN EN 60034-1	---	-	155		

Latest amendment: 2008-01-29

1) 2)

Manufacturing tolerance ±5 %

3)

(...) Values for motors with holding brake, sorted (holding brake 1, holding brake 2 ...)

Fig.4-123:

technical data

Technical Data

Designation	Symbol	Unit	MSK101D-0200-FN	MSK101D-0300-FN	MSK101D-0450-FN
UL Files (UL)			E163211		
Continuous torque at standstill 60 K	M_{0_60}	Nm	50.0		
Continuous current at standstill 60 K	$I_{0_60(rms)}$	A	22.2	30.6	41.7
Continuous torque at standstill 100 K	M_{0_100}	Nm	57.0		
Continuous current at standstill 100 K	$I_{0_100(rms)}$	A	26.8	34.9	50.6
Standstill continuous torque liquid	M_{0_L}	Nm	95.0		
Continuous standstill current liquid	$I_{0_L(rms)}$	A	43.3	58.1	79.2
Maximum torque	M_{max}	Nm	160.0		
Maximum Current	$I_{max(rms)}$	A	99.9	137.7	187.7
Torque constant at 20 °C ¹⁾	K_{M_N}	Nm/A	2.48	1.80	1.32
Voltage constant at 20 °C ²⁾	K_{EMK_1000}	V/min ⁻¹	152.0	113.0	81.0
Winding resistance at 20 °C	R_{12}	ohms	0.35	0.19	0.10
Winding inductivity	L_{12}	mH	6.000	3.200	1.700
Discharge capacity of the component	C_{dis}	nF	13.2	9.1	13.2
Number of pole pairs	p	-	4		
Moment of inertia of the rotor	J_{rot}	kg*m ²	0.00932		
Thermal time constant	T_{th}	min	30.0	100.0	
Maximum speed	n_{max}	min ⁻¹	3,400	4,600	6,000
Sound pressure level	L_P	dB[A]	<75		
Weight ³⁾	m	kg	40.0 (43.8) (46.2)		
Ambient temperature in operation	T_{amb}	°C	0 ... 40		
Type of protection according to IEC 60529	---	-	IP65		
Insulation class according to DIN EN 60034-1	---	-	155		
Data liquid cooling					
Power loss to be dissipated	P_V	kW	1.2		
Coolant inlet temperature	T_{ein}	°C	10 ... 40		
Permitted coolant temperature rise at P_V	ΔT	K	10		
Required coolant flow at P_V	Q_{min}	l/min	1.7		
Latest amendment: 2008-05-14					

Designation	Symbol	Unit	MSK101D-0200-FN	MSK101D-0300-FN	MSK101D-0450-FN
Pressure loss at Q_{min}	Δp	bar	0.9		
Maximum permitted inlet pressure	p_{max}	bar	3.0		
Volume of coolant duct	V_{kuehl}	l	0.11		
Latest amendment: 2008-05-14					

1) 2) Manufacturing tolerance $\pm 5\%$
 3) (...) Values for motors with holding brake, sorted (holding brake 1, holding brake 2 ...)
Fig. 4-124: technical data

Designation	Symbol	Unit	Holding brake 2	Holding brake 3
Holding torque	M_4	Nm	70.0	120.0
Rated voltage	U_N	V	24	
Rated current	I_N	A	1.29	1.46
Connection time	t_1	ms	53	80
Disconnection time	t_2	ms	97	150
Moment of inertia of the holding brake	J_{rot}	kg*m ²	0.003000	0.005750
Latest amendment: 2005-05-17				

Fig. 4-125: Holding brakes - Technical data (optional)

Motor Characteristic Curves

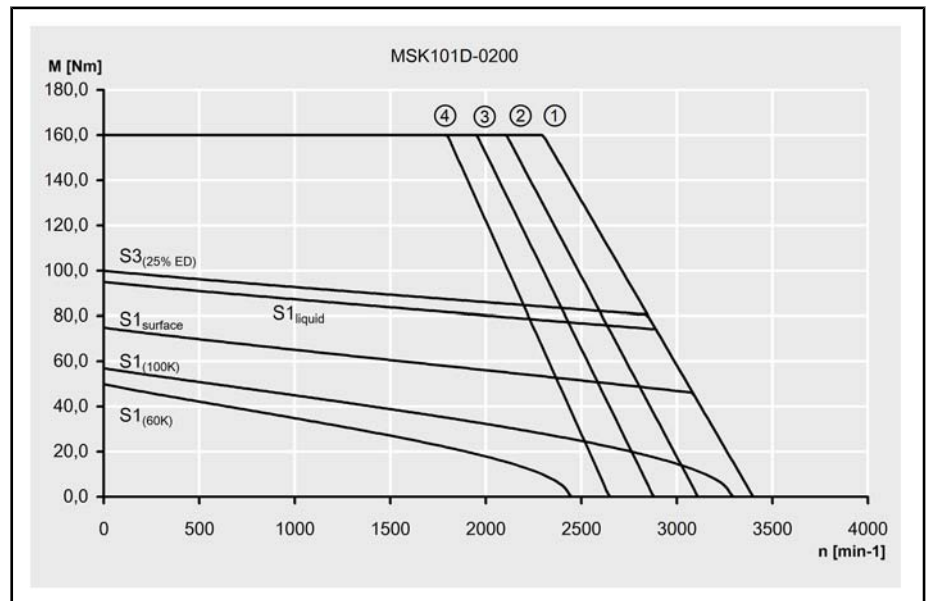

- ① Mmax for IndraDrive, controlled feed, 3 x AC 400 V
- ② Mmax for IndraDrive, uncontrolled feed, 3 x AC 480 V
- ③ Mmax for IndraDrive, uncontrolled feed, 3 x AC 440 V
- ④ Mmax for IndraDrive, uncontrolled feed, 3 x AC 400 V

Fig. 4-126: Characteristic curve of a MSK101D-0200 motor

Technical Data

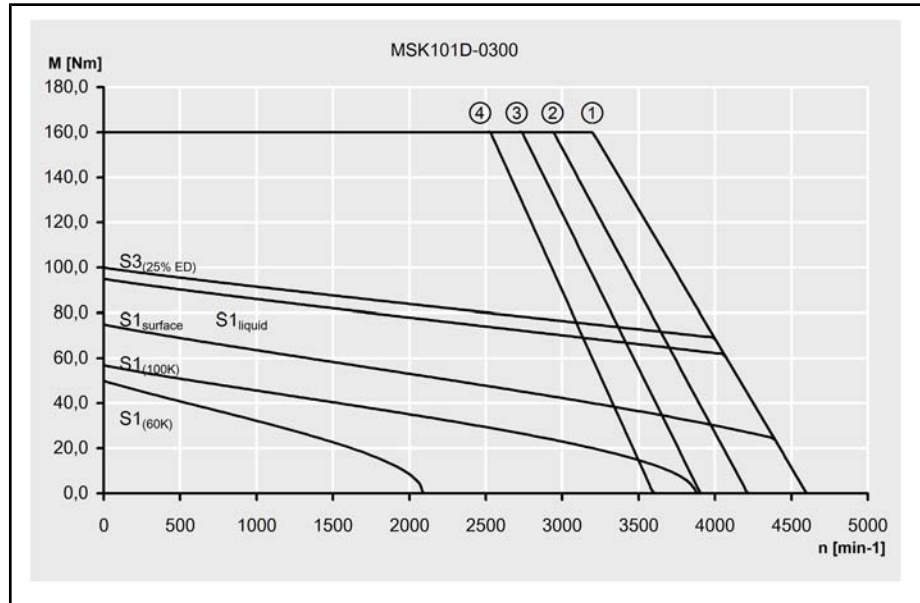

- ① Mmax for IndraDrive, controlled feed, 3 x AC 400 V
- ② Mmax for IndraDrive, uncontrolled feed, 3 x AC 480 V
- ③ Mmax for IndraDrive, uncontrolled feed, 3 x AC 440 V
- ④ Mmax for IndraDrive, uncontrolled feed, 3 x AC 400 V

Fig.4-127: Characteristic curve of a MSK101D-300 motor

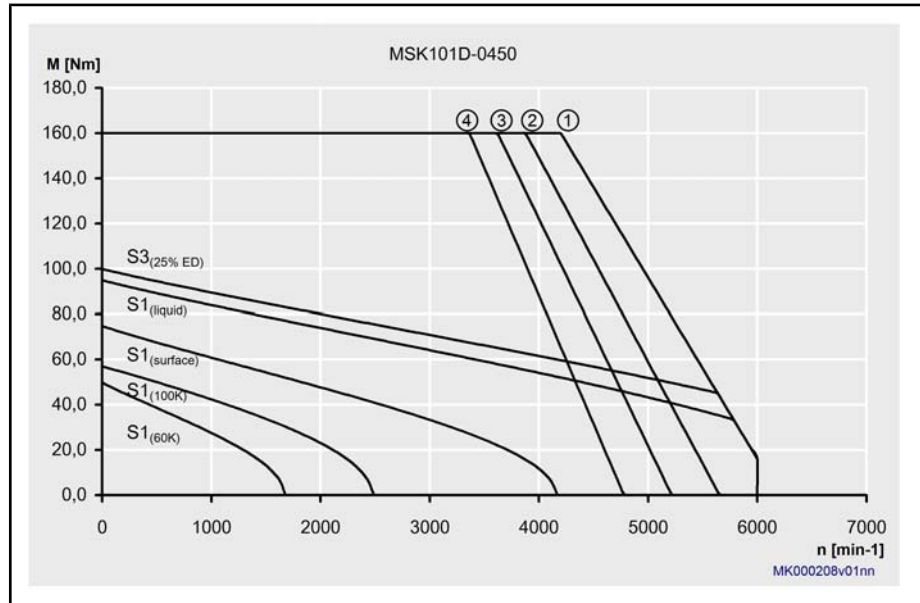

- ① Mmax for IndraDrive, controlled feed, 3 x AC 400 V
- ② Mmax for IndraDrive, uncontrolled feed, 3 x AC 480 V
- ③ Mmax for IndraDrive, uncontrolled feed, 3 x AC 440 V
- ④ Mmax for IndraDrive, uncontrolled feed, 3 x AC 400 V

Fig.4-128: Characteristic curve of a MSK101D-0450 motor

4.28 MSK101E - Technical Data

Designation	Symbol	Unit	MSK101E-0200-NN	MSK101E-0300-NN	MSK101E-0450-NN
UL Files (UL)			E163211		
Continuous torque at standstill 60 K	M_{0_60}	Nm	70.0		
Continuous current at standstill 60 K	$I_{0_60(rms)}$	A	32.1	41.6	58.3
Continuous torque at standstill 100 K	M_{0_100}	Nm	80.5		
Continuous current at standstill 100 K	$I_{0_100(rms)}$	A	39.0	47.8	67.6
Continuous torque at standstill, surface	M_{0_S}	Nm	105.0		
Continuous current at standstill, surface	$I_{0_S(rms)}$	A	48.2	62.4	87.5
Maximum torque	M_{max}	Nm	231.0		
Maximum current	$I_{max(rms)}$	A	144.5	187.4	262.4
Torque constant at 20 °C ¹⁾	K_{M_N}	Nm/A	2.40	1.85	1.32
Voltage constant at 20 °C ²⁾	K_{EMK_1000}	V/min ⁻¹	148.0	113.8	81.2
Winding resistance at 20 °C	R_{12}	ohms	0.18	0.11	0.06
Winding inductivity	L_{12}	mH	3.300	1.960	1.080
Discharge capacity of the component	C_{dis}	nF	15.2	16.7	
Number of pole pairs	p	-	4		
Moment of inertia of the rotor	J_{rot}	kg*m ²	0.01380		
Thermal time constant	T_{th}	min	100.0		
Maximum speed	n_{max}	min ⁻¹	3,500	4,600	6,000
Sound pressure level	L_P	dB[A]	<75		
Weight ³⁾	m	kg	53.5 (57.3) (59.7)		
Ambient temperature in operation	T_{amb}	°C	0 ... 40		
Type of protection according to IEC 60529	---	-	IP65		
Insulation class according to DIN EN 60034-1	---	-	155		

Latest amendment: 2008-01-29

1) 2)

Manufacturing tolerance ±5 %

3)

(...) Values for motors with holding brake, sorted (holding brake 1, holding brake 2 ...)

Fig.4-129:

MSK - Technical data (standard and air cooling)

Technical Data

Designation	Symbol	Unit	MSK101E-0200-FN	MSK101E-0300-FN	MSK101E-0450-FN
UL Files (UL)			E163211		
Continuous torque at standstill 60 K	M_{0_60}	Nm	70.0		
Continuous current at standstill 60 K	$I_{0_60(rms)}$	A	32.1	41.6	58.3
Continuous torque at standstill 100 K	M_{0_100}	Nm	80.5		
Continuous current at standstill 100 K	$I_{0_100(rms)}$	A	39.0	47.8	67.6
Standstill continuous torque liquid	M_{0_L}	Nm	133.0		116.0
Continuous standstill current liquid	$I_{0_L(rms)}$	A	63.8	79.0	97.0
Maximum torque	M_{max}	Nm	231.0		
Maximum Current	$I_{max(rms)}$	A	144.5	187.4	262.4
Torque constant at 20 °C ¹⁾	K_{M_N}	Nm/A	2.40	1.85	1.32
Voltage constant at 20 °C ²⁾	K_{EMK_1000}	V/min ⁻¹	148.0	113.8	81.2
Winding resistance at 20 °C	R_{12}	ohms	0.18	0.11	0.06
Winding inductivity	L_{12}	mH	3.300	1.960	1.080
Discharge capacity of the component	C_{dis}	nF	15.2	16.7	
Number of pole pairs	p	-	4		
Moment of inertia of the rotor	J_{rot}	kg*m ²	0.01380		
Thermal time constant	T_{th}	min	100.0		
Maximum speed	n_{max}	min ⁻¹	3500	4600	6000
Sound pressure level	L_P	dB[A]	<75		
Weight ³⁾	m	kg	53.5 (57.3) (59.7)		
Ambient temperature in operation	T_{amb}	°C	0 ... 40		
Type of protection according to IEC 60529	---	-	IP65		
Insulation class according to DIN EN 60034-1	---	-	155		
Data liquid cooling					
Power loss to be dissipated	P_V	kW	1.3		
Coolant inlet temperature	T_{ein}	°C	10 ... 40		
Permitted coolant temperature rise at P_V	ΔT	K	10		

Latest amendment: 2008-06-09

Designation	Symbol	Unit	MSK101E-0200-FN	MSK101E-0300-FN	MSK101E-0450-FN
Required coolant flow at Pv	Q_{min}	l/min	1.8		
Pressure loss at Q_{min}	Δp	bar	1.0		
Maximum permitted inlet pressure	p_{max}	bar	3.0		
Volume of coolant duct	V_{kuehl}	l	0.14		
Latest amendment: 2008-06-09					

1) 2) Manufacturing tolerance $\pm 5\%$
 3) (...) Values for motors with holding brake, sorted (holding brake 1, holding brake 2 ...)

Fig.4-130: MSK - Technical data (standard and liquid cooling)

Designation	Symbol	Unit	Holding brake 2	Holding brake 3
Holding torque	M_4	Nm	70.0	120.0
Rated voltage	U_N	V	24	
Rated current	I_N	A	1.29	1.46
Connection time	t_1	ms	53	80
Disconnection time	t_2	ms	97	150
Moment of inertia of the holding brake	J_{rot}	kg*m ²	0.003000	0.005750
Latest amendment: 2005-05-17				

Fig.4-131: Holding brakes - Technical data (optional)

Characteristic Motor Curves

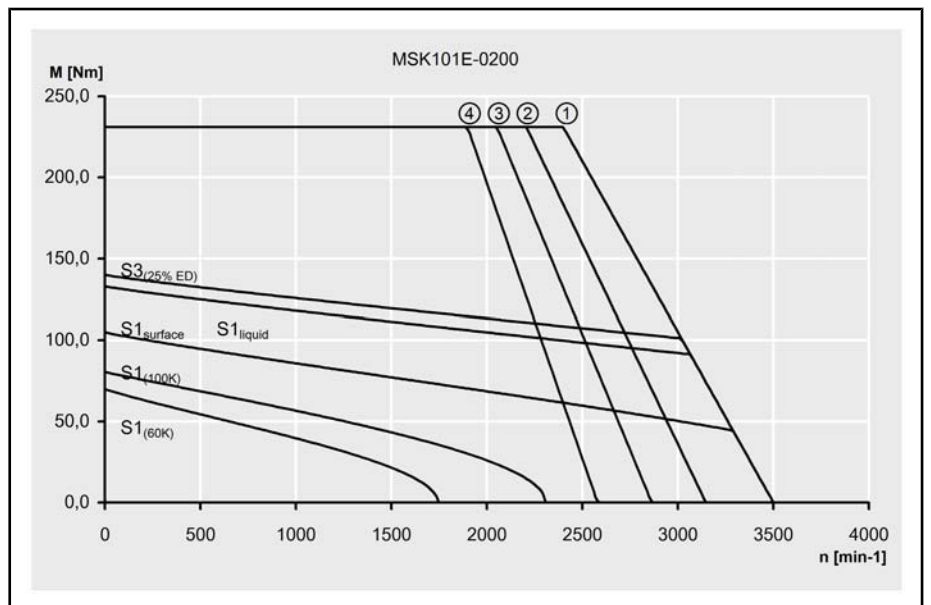

- ① Mmax for IndraDrive, controlled feed, 3 x AC 400 V
- ② Mmax for IndraDrive, uncontrolled feed, 3 x AC 480 V
- ③ Mmax for IndraDrive, uncontrolled feed, 3 x AC 440 V
- ④ Mmax for IndraDrive, uncontrolled feed, 3 x AC 400 V

Fig.4-132: Characteristic curve of a MSK101E-0200 motor

Technical Data

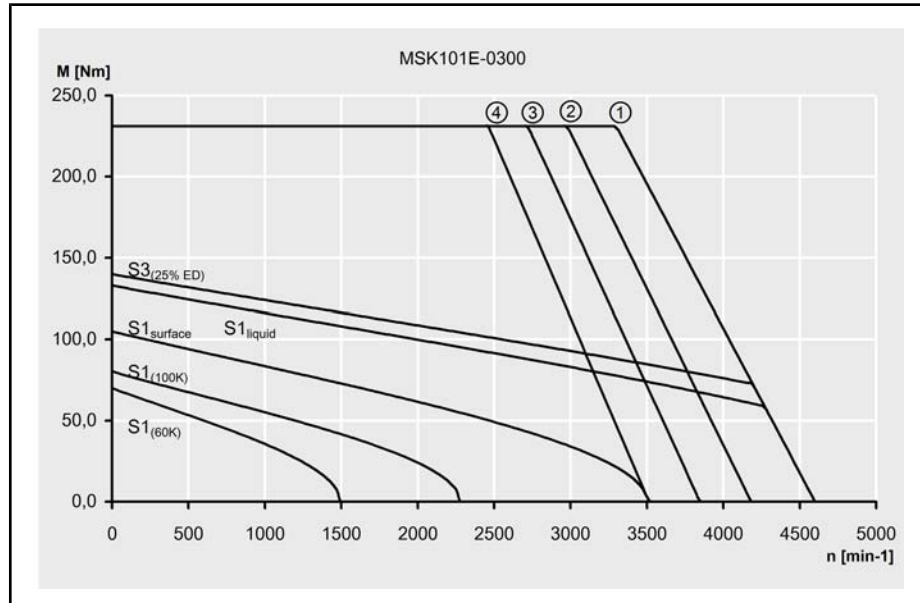

- ① Mmax for IndraDrive, controlled feed, 3 x AC 400 V
- ② Mmax for IndraDrive, uncontrolled feed, 3 x AC 480 V
- ③ Mmax for IndraDrive, uncontrolled feed, 3 x AC 440 V
- ④ Mmax for IndraDrive, uncontrolled feed, 3 x AC 400 V

Fig.4-133: Characteristic curve of a MSK101E-300 motor

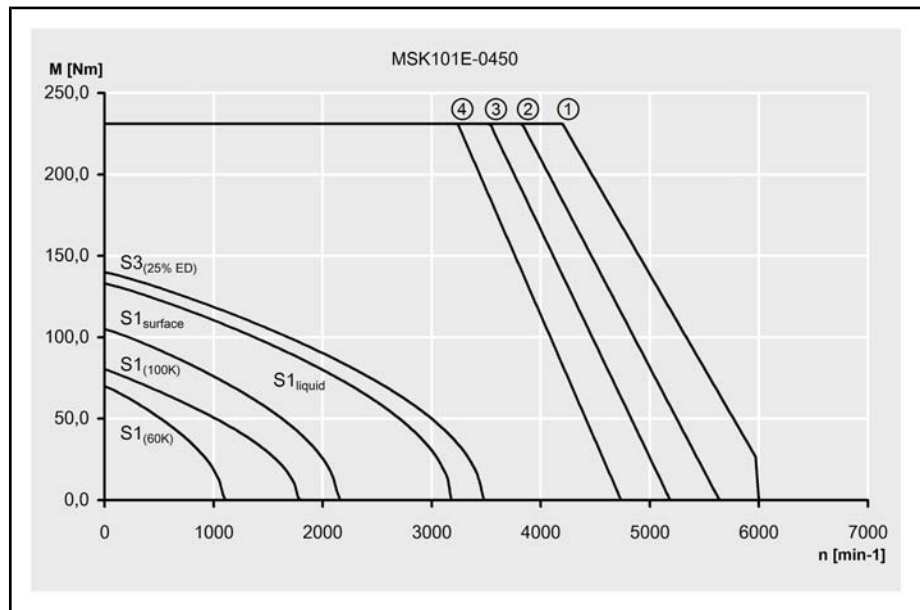

- ① Mmax for IndraDrive, controlled feed, 3 x AC 400 V
- ② Mmax for IndraDrive, uncontrolled feed, 3 x AC 480 V
- ③ Mmax for IndraDrive, uncontrolled feed, 3 x AC 440 V
- ④ Mmax for IndraDrive, uncontrolled feed, 3 x AC 400 V

Fig.4-134: Characteristic curve of a MSK101E-0450 motor

4.29 MSK103A - Technical Data

Designation	Symbol	Unit	MSK103A-0300-NN
UL Files (UL)			E163211
Continuous torque at standstill 60 K	M_{0_60}	Nm	21.0
Continuous current at standstill 60 K	$I_{0_60(rms)}$	A	12.5
Continuous torque at standstill 100 K	M_{0_100}	Nm	24.0
Continuous current at standstill 100 K	$I_{0_100(rms)}$	A	14.3
Maximum torque	M_{max}	Nm	54.0
Maximum Current	$I_{max(rms)}$	A	40.0
Torque constant at 20 °C ¹⁾	K_{M_N}	Nm/A	1.74
Voltage constant at 20 °C ²⁾	K_{EMK_1000}	V/min ⁻¹	111.0
Winding resistance at 20 °C	R_{12}	ohms	0.59
Winding inductivity	L_{12}	mH	12.800
Discharge capacity of the component	C_{dis}	nF	1.5
Number of pole pairs	p	-	4
Moment of inertia of the rotor	J_{rot}	kg*m ²	0.00442
Thermal time constant	T_{th}	min	25.0
Maximum speed	n_{max}	min ⁻¹	5,200
Sound pressure level	L_P	dB[A]	<75
Weight ³⁾	m	kg	18.0 (21.5)
Ambient temperature in operation	T_{amb}	°C	0 ... 40
Type of protection according to IEC 60529	---	-	IP65
Insulation class according to DIN EN 60034-1	---	-	155
Latest amendment: 2008-09-26			

1) 2) Manufacturing tolerance ±5 %

3) (...) Values for motors with holding brake, sorted (holding brake 1, holding brake 2 ...)

Fig.4-135: MSK - Technical data (standard cooling)

Designation	Symbol	Unit	Holding brake 1
Holding torque	M_4	Nm	33
Rated voltage	U_N	V	24
Latest amendment: 2008-07-09			

Technical Data

Designation	Symbol	Unit	Holding brake 1
Rated current	I_N	A	0.94
Connection time	t_1	ms	40
Disconnection time	t_2	ms	270
Moment of inertia of the holding brake	J_{rot}	kg*m ²	0.00106

Latest amendment: 2008-07-09

Fig.4-136: Holding brakes - Technical data (optional)

Characteristic Motor Curves

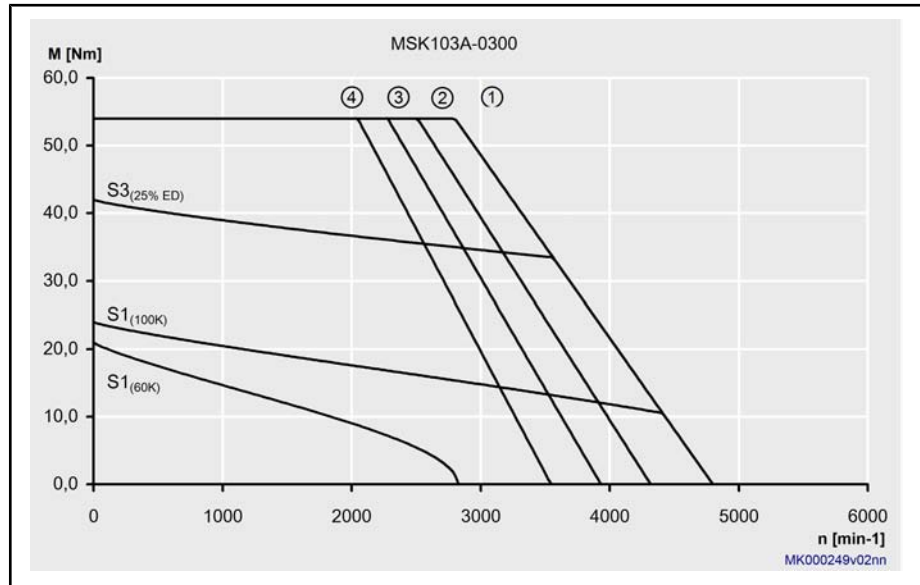

- ① Mmax for IndraDrive, controlled feed, 3 x AC 400 V
- ② Mmax for IndraDrive, uncontrolled feed, 3 x AC 480 V
- ③ Mmax for IndraDrive, uncontrolled feed, 3 x AC 440 V
- ④ Mmax for IndraDrive, uncontrolled feed, 3 x AC 400 V

Fig.4-137: Characteristic curve of a MSK103A-0300 motor

4.30 MSK103B - Technical Data

Designation	Symbol	Unit	MSK103B-0300-NN
UL Files (UL)			E163211
Continuous torque at standstill 60 K	$M_{0,60}$	Nm	28.0
Continuous current at standstill 60 K	$I_{0,60(rms)}$	A	17.0
Continuous torque at standstill 100 K	$M_{0,100}$	Nm	31.0
Continuous current at standstill 100 K	$I_{0,100(rms)}$	A	19.0
Maximum torque	M_{max}	Nm	85.0
Maximum Current	$I_{max(rms)}$	A	63.0
Torque constant at 20 °C ¹⁾	$K_{M,N}$	Nm/A	1.76
Voltage constant at 20 °C ²⁾	$K_{EMK,1000}$	V/min ⁻¹	108.0
Winding resistance at 20 °C	R_{12}	ohms	0.35
Winding inductivity	L_{12}	mH	8.000
Discharge capacity of the component	C_{dis}	nF	2.1
Number of pole pairs	p	-	4
Moment of inertia of the rotor	J_{rot}	kg*m ²	0.00594
Thermal time constant	T_{th}	min	27.0
Maximum speed	n_{max}	min ⁻¹	4,700
Sound pressure level	L_P	dB[A]	<75
Weight ³⁾	m	kg	22.5 (26.0)
Ambient temperature in operation	T_{amb}	°C	0 ... 40
Type of protection according to IEC 60529	---	-	IP65
Insulation class according to DIN EN 60034-1	---	-	155
Latest amendment: 2008-08-28			

1) 2) Manufacturing tolerance $\pm 5\%$

3) (...) Values for motors with holding brake, sorted (holding brake 1, holding brake 2 ...)

Fig.4-138: MSK - Technical data (standard cooling)

Designation	Symbol	Unit	Holding brake 1
Holding torque	M_4	Nm	33.0
Rated voltage	U_N	V	24
Latest amendment: 2008-07-09			

Technical Data

Designation	Symbol	Unit	Holding brake 1
Rated current	I_N	A	0.94
Connection time	t_1	ms	40
Disconnection time	t_2	ms	270
Moment of inertia of the holding brake	J_{rot}	kg*m ²	0.001060

Latest amendment: 2008-07-09

Fig.4-139: Holding brakes - Technical data (optional)

Characteristic Motor Curves

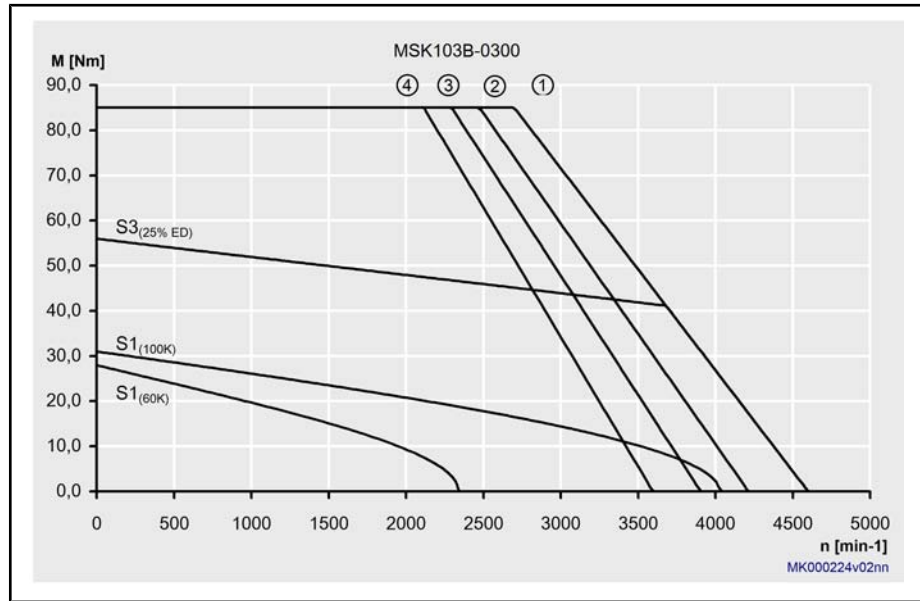

- ① M_{max} for IndraDrive, controlled feed, 3 x AC 400 V
- ② M_{max} for IndraDrive, uncontrolled feed, 3 x AC 480 V
- ③ M_{max} for IndraDrive, uncontrolled feed, 3 x AC 440 V
- ④ M_{max} for IndraDrive, uncontrolled feed, 3 x AC 400 V

Fig.4-140: Characteristic curve of a MSK103B-0300 motor

4.31 MSK103D - Technical Data

Designation	Symbol	Unit	MSK103D-0300-NN
UL Files (UL)			E163211
Continuous torque at standstill 60 K	M_{0_60}	Nm	46.0
Continuous current at standstill 60 K	$I_{0_60(rms)}$	A	26.3
Continuous torque at standstill 100 K	M_{0_100}	Nm	53.0
Continuous current at standstill 100 K	$I_{0_100(rms)}$	A	30.8
Maximum torque	M_{max}	Nm	138.0
Maximum Current	$I_{max(rms)}$	A	94.7
Torque constant at 20 °C ¹⁾	K_{M_N}	Nm/A	1.84
Voltage constant at 20 °C ²⁾	K_{EMK_1000}	V/min ⁻¹	113.0
Winding resistance at 20 °C	R_{12}	ohms	0.19
Winding inductivity	L_{12}	mH	4.870
Discharge capacity of the component	C_{dis}	nF	6.0
Number of pole pairs	p	-	4
Moment of inertia of the rotor	J_{rot}	kg*m ²	0.00894
Thermal time constant	T_{th}	min	36.0
Maximum speed	n_{max}	min ⁻¹	4600
Sound pressure level	L_P	dB[A]	<75
Weight ³⁾	m	kg	31.6 (36.1)
Ambient temperature in operation	T_{amb}	°C	0 ... 40
Type of protection according to IEC 60529	---	-	IP65
Insulation class according to DIN EN 60034-1	---	-	155
Latest amendment: 2008-09-26			

1) 2) Manufacturing tolerance $\pm 5\%$

3) (...) Values for motors with holding brake, sorted (holding brake 1, holding brake 2 ...)

Fig.4-141: MSK - Technical data (standard cooling)

Technical Data

Characteristic Motor Curves

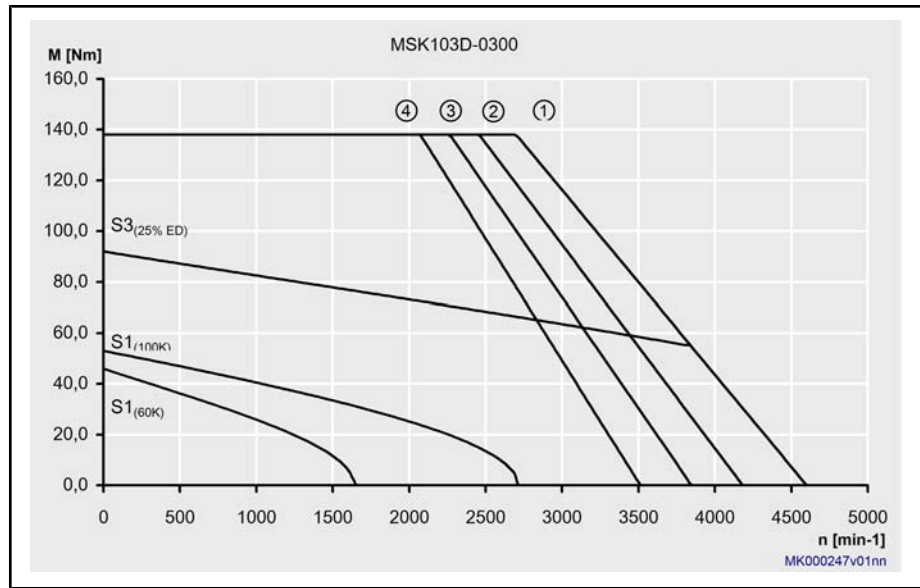

- ① Mmax for IndraDrive, controlled feed, 3 x AC 400 V
- ② Mmax for IndraDrive, uncontrolled feed, 3 x AC 480 V
- ③ Mmax for IndraDrive, uncontrolled feed, 3 x AC 440 V
- ④ Mmax for IndraDrive, uncontrolled feed, 3 x AC 400 V

Fig. 4-142: Characteristic curve of a MSK103D-0300 motor

4.32 MSK131B - Technical Data

Designation	Symbol	Unit	MSK131B-0200-NN
UL Files (UL)			E163211
Continuous torque at standstill 60 K	M_{0_60}	Nm	85.0
Continuous current at standstill 60 K	$I_{0_60(rms)}$	A	36.7
Continuous torque at standstill 100 K	M_{0_100}	Nm	---
Continuous current at standstill 100 K	$I_{0_100(rms)}$	A	---
Continuous torque at standstill. surface	M_{0_S}	Nm	127.5
Continuous current at standstill. surface	$I_{0_S(rms)}$	A	55.1
Maximum torque	M_{max}	Nm	250.0
Maximum Current	$I_{max(rms)}$	A	165.0
Torque constant at 20 °C ¹⁾	K_{M_N}	Nm/A	2.55
Voltage constant at 20 °C ²⁾	K_{EMK_1000}	V/min ⁻¹	155.0
Winding resistance at 20 °C	R_{12}	ohms	0.16
Winding inductivity	L_{12}	mH	5.300
Discharge capacity of the component	C_{dis}	nF	14.3
Number of pole pairs	p	-	4
Moment of inertia of the rotor	J_{rot}	kg*m ²	0.02320
Thermal time constant	T_{th}	min	82.0
Maximum speed	n_{max}	min ⁻¹	3,200
Sound pressure level	L_P	dB[A]	<75
Weight ³⁾	m	kg	84.0 (89.4)
Ambient temperature in operation	T_{amb}	°C	0 ... 40
Type of protection according to IEC 60529	---	-	IP65
Insulation class according to DIN EN 60034-1	---	-	155

Latest amendment: 2008-10-21

1) 2)

Manufacturing tolerance ±5 %

3)

(...) Values for motors with holding brake, sorted (holding brake 1, holding brake 2 ...)

Fig.4-143:

MSK - Technical data (standard and air cooling)

Technical Data

Designation	Symbol	Unit	Holding brake 1
Holding torque	M_4	Nm	100.0
Rated voltage	U_N	V	24
Rated current	I_N	A	2.00
Connection time	t_1	ms	70
Disconnection time	t_2	ms	190
Moment of inertia of the holding brake	J_{rot}	kg*m ²	0.005300

Latest amendment: 2003-12-09

Fig.4-144: Holding brakes - Technical data (optional)

Characteristic Motor Curves

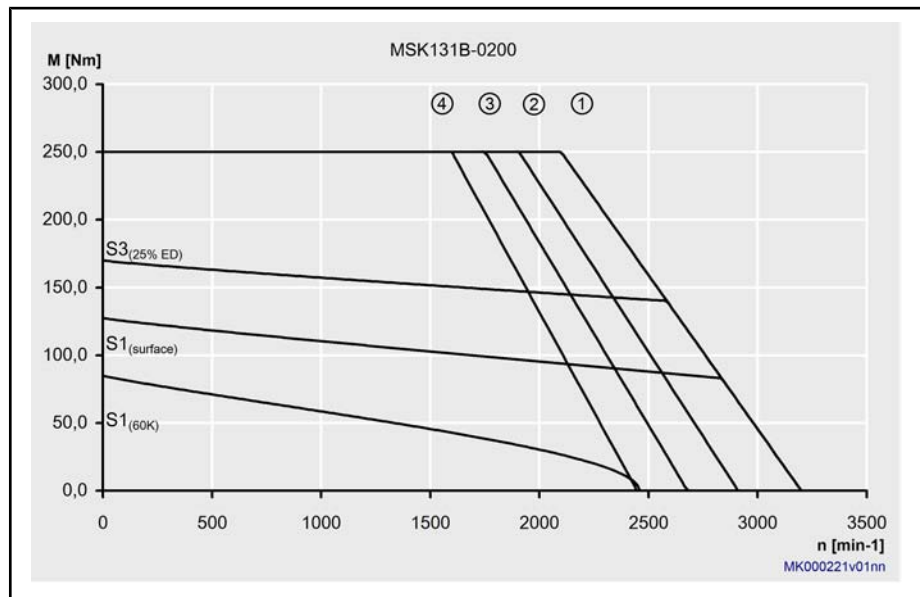

- ① Mmax for IndraDrive, controlled feed, 3 x AC 400 V
- ② Mmax for IndraDrive, uncontrolled feed, 3 x AC 480 V
- ③ Mmax for IndraDrive, uncontrolled feed, 3 x AC 440 V
- ④ Mmax for IndraDrive, uncontrolled feed, 3 x AC 400 V

Fig.4-145: Characteristic curve of a MSK131B-0200 motor

4.33 MSK131D - Technical Data

Designation	Symbol	Unit	MSK131D-0200-NN
UL Files (UL)			-
Continuous torque at standstill 60 K	M_{0_60}	Nm	160.0
Continuous current at standstill 60 K	$I_{0_60(rms)}$	A	65.2
Continuous torque at standstill 100 K	M_{0_100}	Nm	---
Continuous current at standstill 100 K	$I_{0_100(rms)}$	A	---
Continuous torque at standstill. surface	M_{0_S}	Nm	240.0
Continuous current at standstill. surface	$I_{0_S(rms)}$	A	97.8
Maximum torque	M_{max}	Nm	495.0
Maximum Current	$I_{max(rms)}$	A	293.4
Torque constant at 20 °C ¹⁾	K_{M_N}	Nm/A	2.70
Voltage constant at 20 °C ²⁾	K_{EMK_1000}	V/min ⁻¹	170.0
Winding resistance at 20 °C	R_{12}	ohms	0.07
Winding inductivity	L_{12}	mH	3.000
Discharge capacity of the component	C_{dis}	nF	27.7
Number of pole pairs	p	-	4
Moment of inertia of the rotor	J_{rot}	kg*m ²	0.03820
Thermal time constant	T_{th}	min	120.0
Maximum speed	n_{max}	min ⁻¹	3,000
Sound pressure level	L_P	dB[A]	<75
Weight ³⁾	m	kg	116.0 (121.4)
Ambient temperature in operation	T_{amb}	°C	0 ... 40
Type of protection according to IEC 60529	---	-	IP65
Insulation class according to DIN EN 60034-1	---	-	155

Latest amendment: 2008-06-09

1) 2)

Manufacturing tolerance ±5 %

3)

(...) Values for motors with holding brake, sorted (holding brake 1, holding brake 2 ...)

Fig.4-146:

MSK - Technical data (standard and air cooling)

Technical Data

Designation	Symbol	Unit	Holding brake 1	Holding brake 2
Holding torque	M_4	Nm	100.0	240.0
Rated voltage	U_N	V	24	
Rated current	I_N	A	2.00	1.87
Connection time	t_1	ms	70	30
Disconnection time	t_2	ms	190	300
Moment of inertia of the holding brake	J_{rot}	kg*m ²	0.005300	0.018800

Latest amendment: 2003-12-09

Fig.4-147: Holding brakes - Technical data (optional)

Characteristic Motor Curves

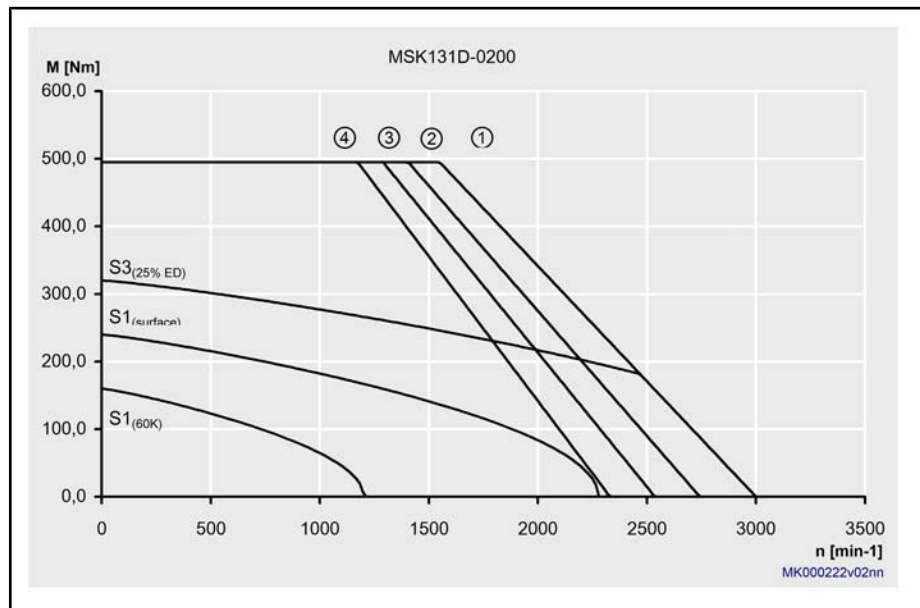

- ① Mmax for IndraDrive, controlled feed. 3 x AC 400 V
- ② Mmax for IndraDrive, uncontrolled feed, 3 x AC 480 V
- ③ Mmax for IndraDrive, uncontrolled feed, 3 x AC 440 V
- ④ Mmax for IndraDrive, uncontrolled feed, 3 x AC 400 V

Fig.4-148: Characteristic curve of a MSK131D-0200 motor

5 Specifications

5.1 Technical Design

Motor design	Motor frame size B5 acc. to EN60034-7 (for additional information see chapter 9.3 "Design and Installation Positions" on page 231)
Housing painting	Black (RAL 9005)
Vibration Severity Grade (Quality of Vibration)	Level A, acc. to EN 60034-14:2004
Concentricity, run-out and alignment	according to DIN 42955, Edition 12.81 (IEC 60072-1)

Encoder	Concentricity tolerance		Run-out and alignment tolerance	
S1, M1	N	---	N	---
S2, M2	---	R	---	R

Fig. 5-1: Tolerance for concentricity, run-out and alignment depend from the encoder option

Flange	according to DIN 42948, ed. 11.65.
Output shaft, shaft end and centering hole	All motors with keyway are balanced with complete key. The machine element to be driven must be balanced without a key. Shaft end cylindrical according to DIN 748, Part 3, ed. 07.75. IEC 60072 (-1). Centering hole, according to DIN 332 Part 2, Edition 05.83

Motor	Corresponding key according to DIN 6885-A (does not belong to scope of delivery of the motors)	Centering hole, according to DIN 332 Part 2, Edition 05.83
MSK030	3×3×16	DS M3
MSK040	5×5 ×20	DS M5
MSK050	6×6×32	DS M6
MSK060	8×7×40	DS M8
MSK061	6×6×32	DS M6
MSK070	10×8×45	DS M10
MSK071	10×8×45	DS M10
MSK075 ¹⁾	10×8×45	DS M10
MSK076	8×7×40	DS M8
MSK100	10×8×45	DS M10
MSK101	10×8×70	DS M12
MSK103 ¹⁾	-	DS M12
MSK131 ¹⁾	14×10×80	DS M16

¹⁾ Motor not available in ATEX design

Fig. 5-2: Key and centering hole

Specifications

5.2 MSK030 Specifications

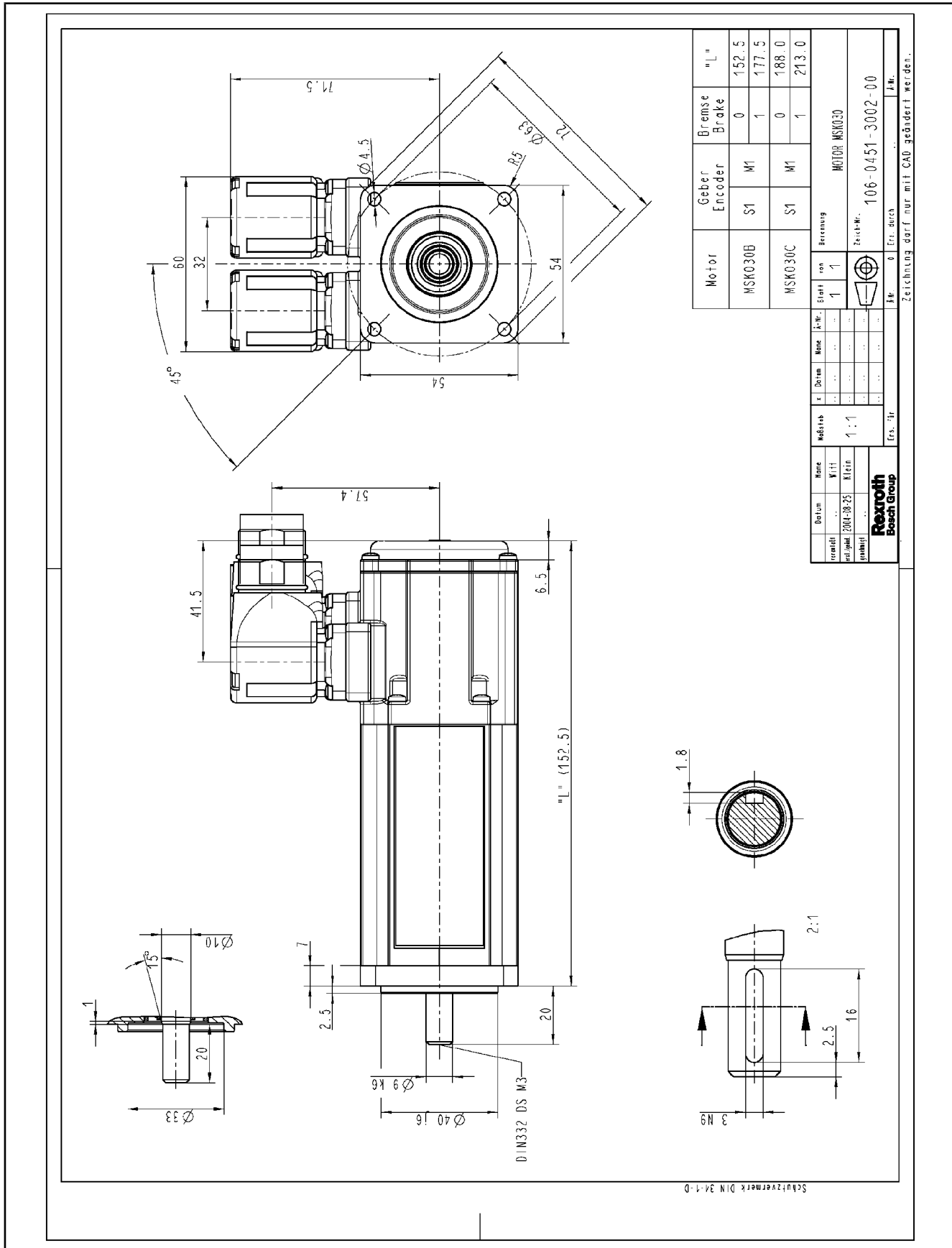

Fig.5-3: MSK030 specification

5.3 MSK040 Specifications

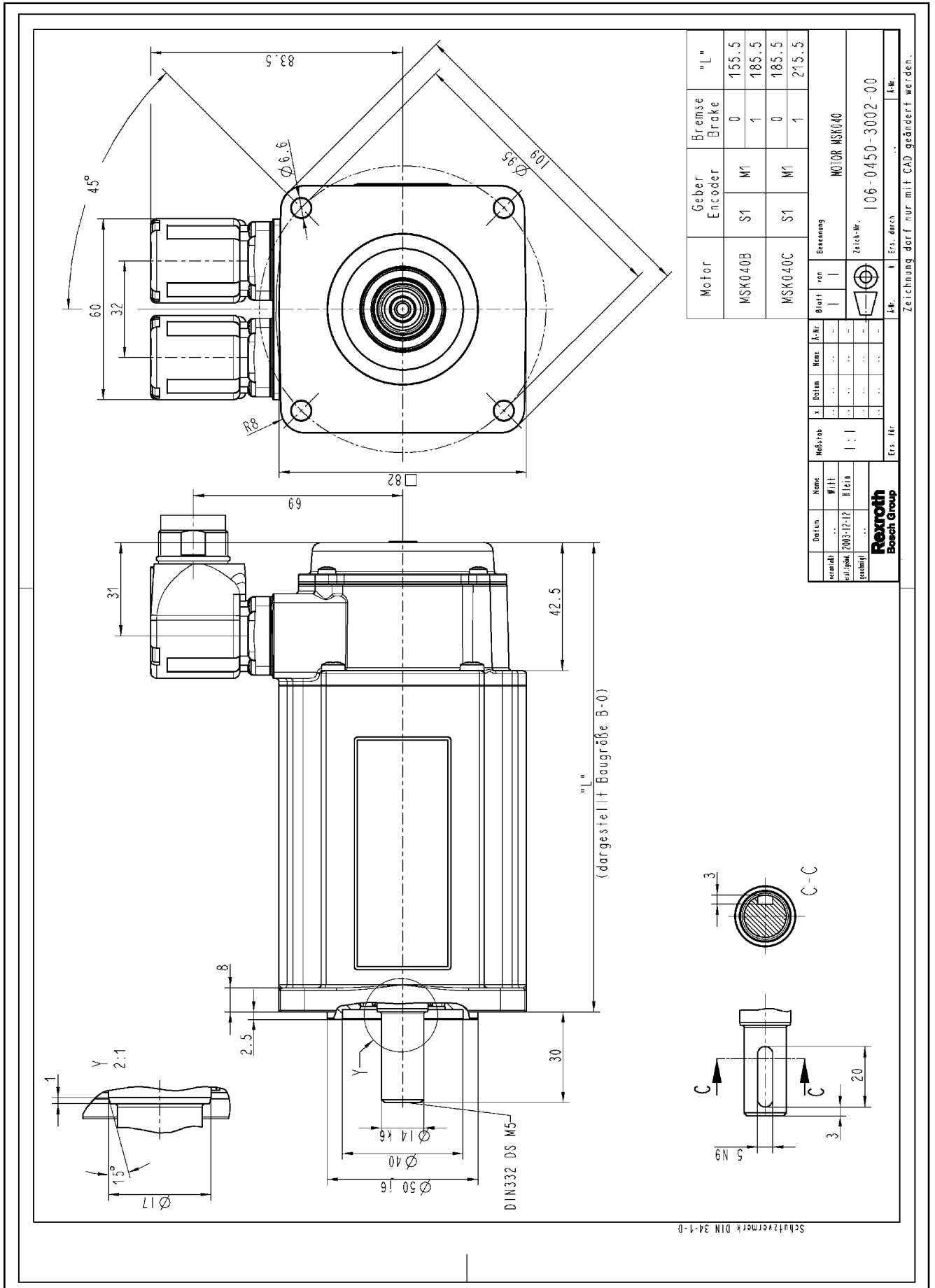

Fig.5-4: MSK040 specification

Specifications

5.4 MSK050 Specifications

Schützvermerk DIN 34-1-0

Motor		Geber Encoder		Bremsbrake		"L"
MSK050B		S1	M1	0	1	173
MSK050C		S1	M1	0	1	203
		S2	M2	0	1	197
		S2	M2	0	1	227
		S1	M1	0	1	203
		S2	M2	0	1	233
		S2	M2	0	1	227
		S2	M2	1	1	257

Motor				Bremsung			
Blatt	von	Motor		Blatt	von	Motor	
1	1	MSK050		1	1	MSK050	
Zeich-Nr.				106-0421-3001-00			

Druck 0 Ers. durch
Zeichnung darf nur mit CAD geändert werden.

Version	Datum	Benennung	Blatt	von
...

Maßstab	Maßstab	Blatt	von
1:2

Druck	Benennung
...	...

Fig.5-5: MSK050 specification

5.5 MSK060 Specifications

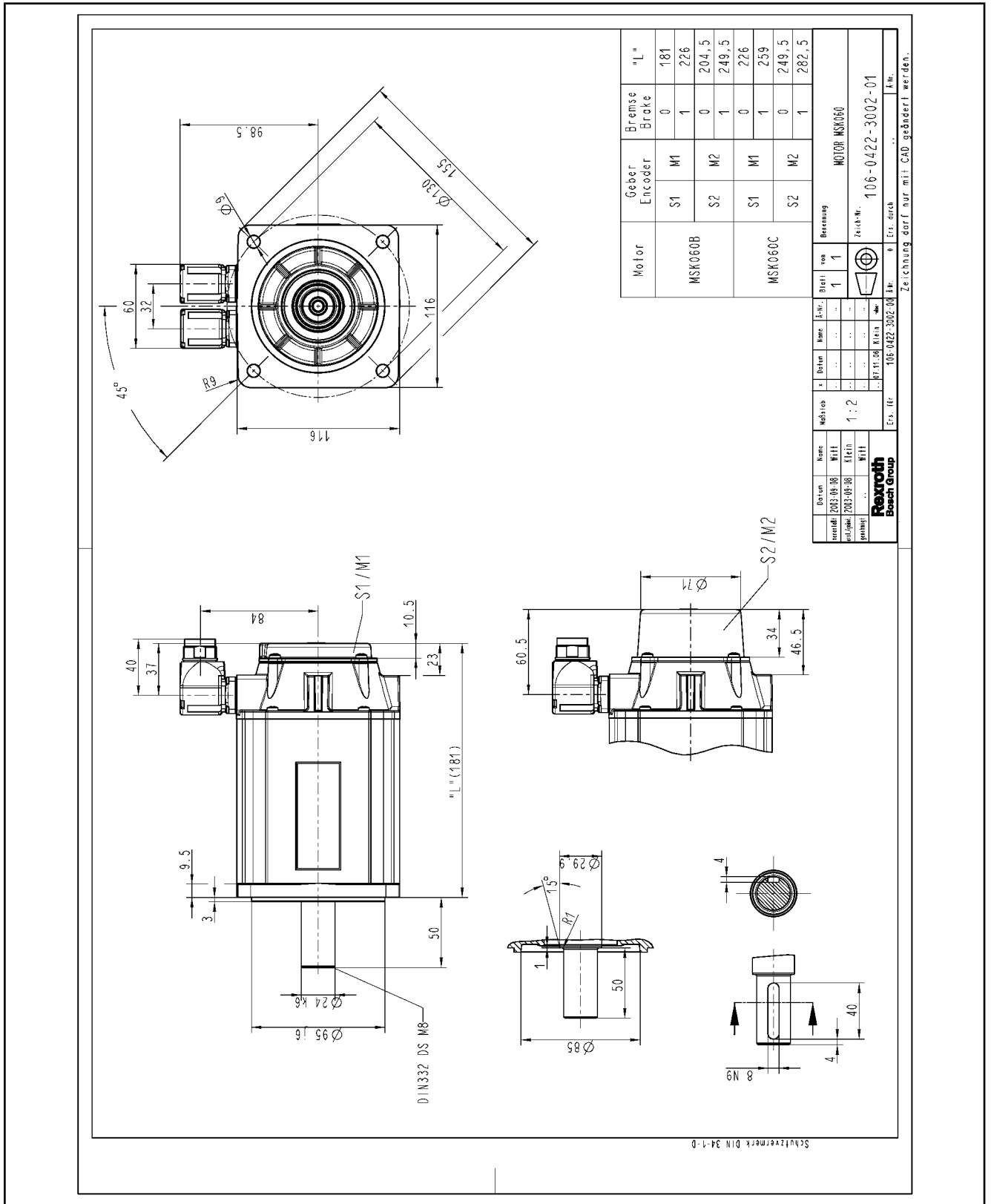

Fig.5-6: MSK060 specification

Specifications

5.6 MSK061 Specifications

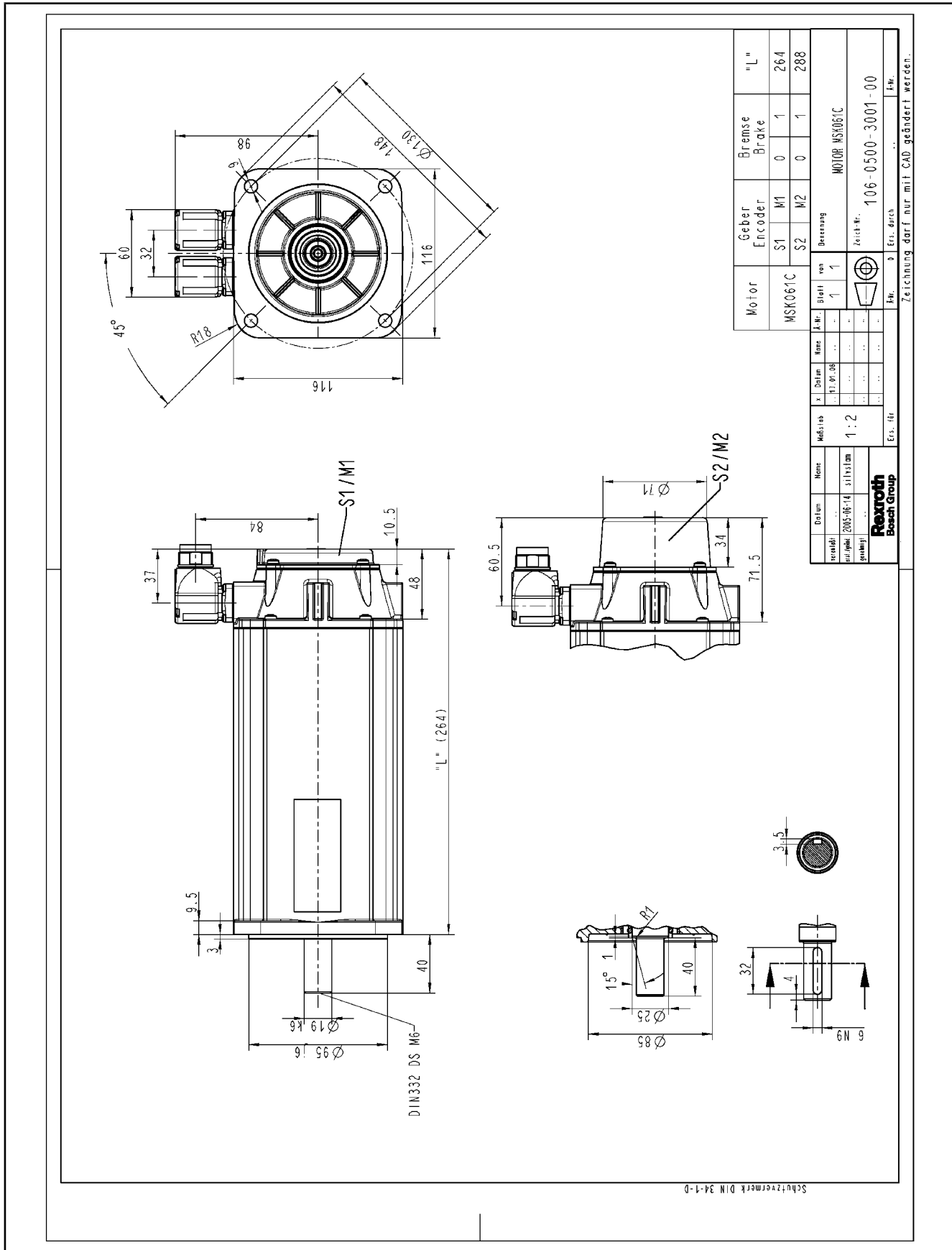

Fig.5-7: MSK061 specification

5.7 MSK070 Specifications

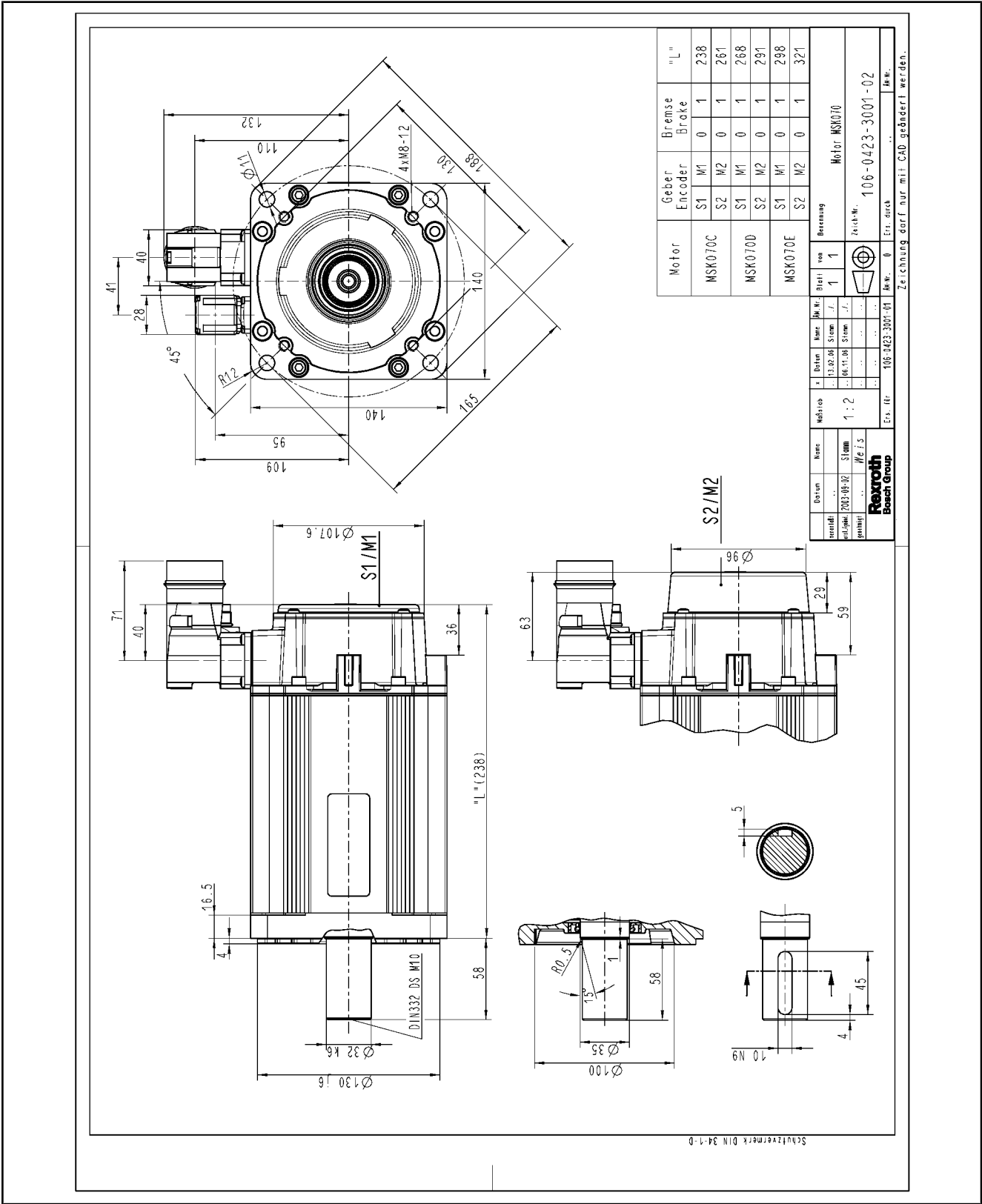

Fig.5-8: MSK070 specification

Specifications

5.8 MSK071 Specifications

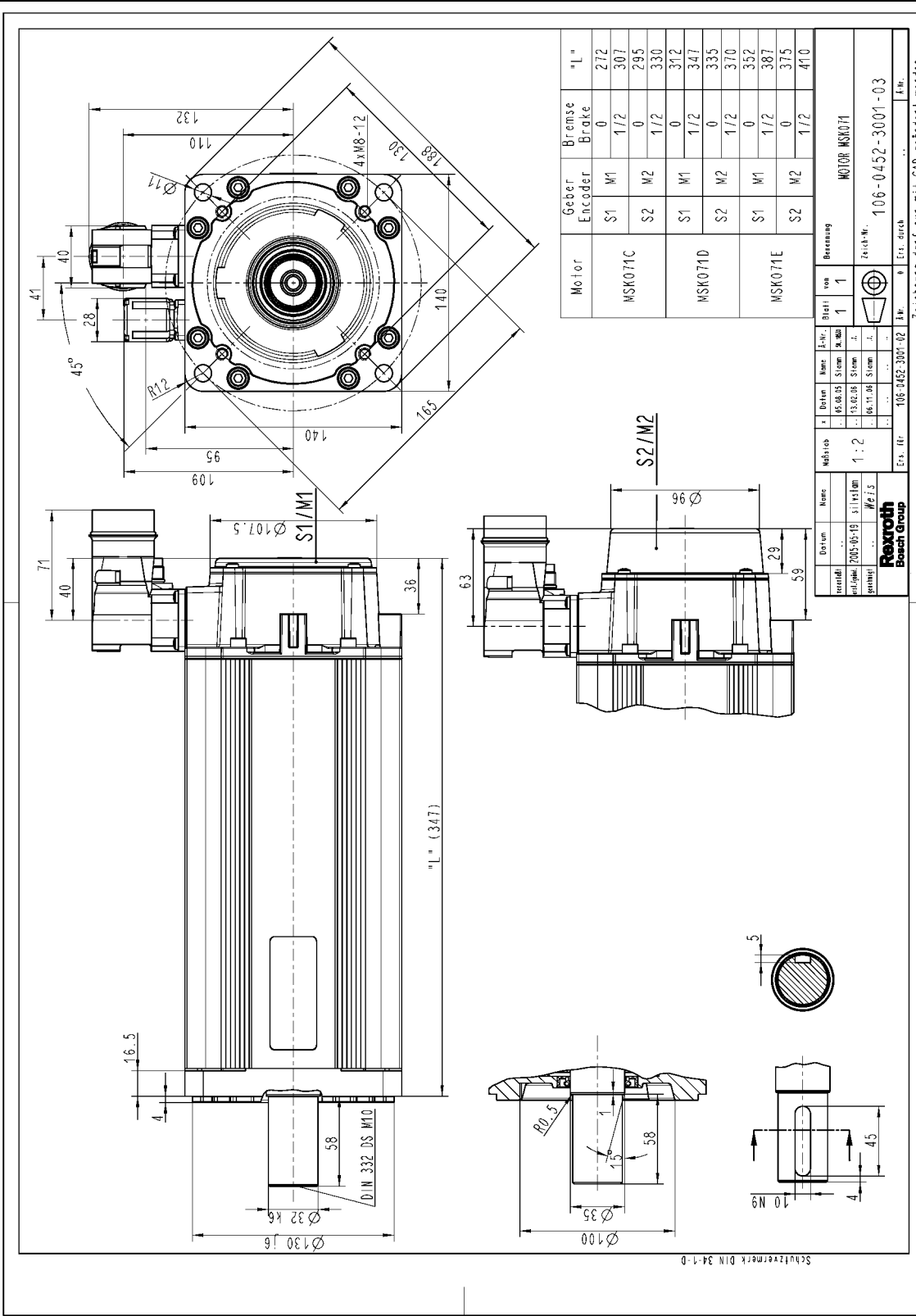

Fig.5-9: MSK071...NN specification

5.9 MSK071 Specifications Liquid Cooling

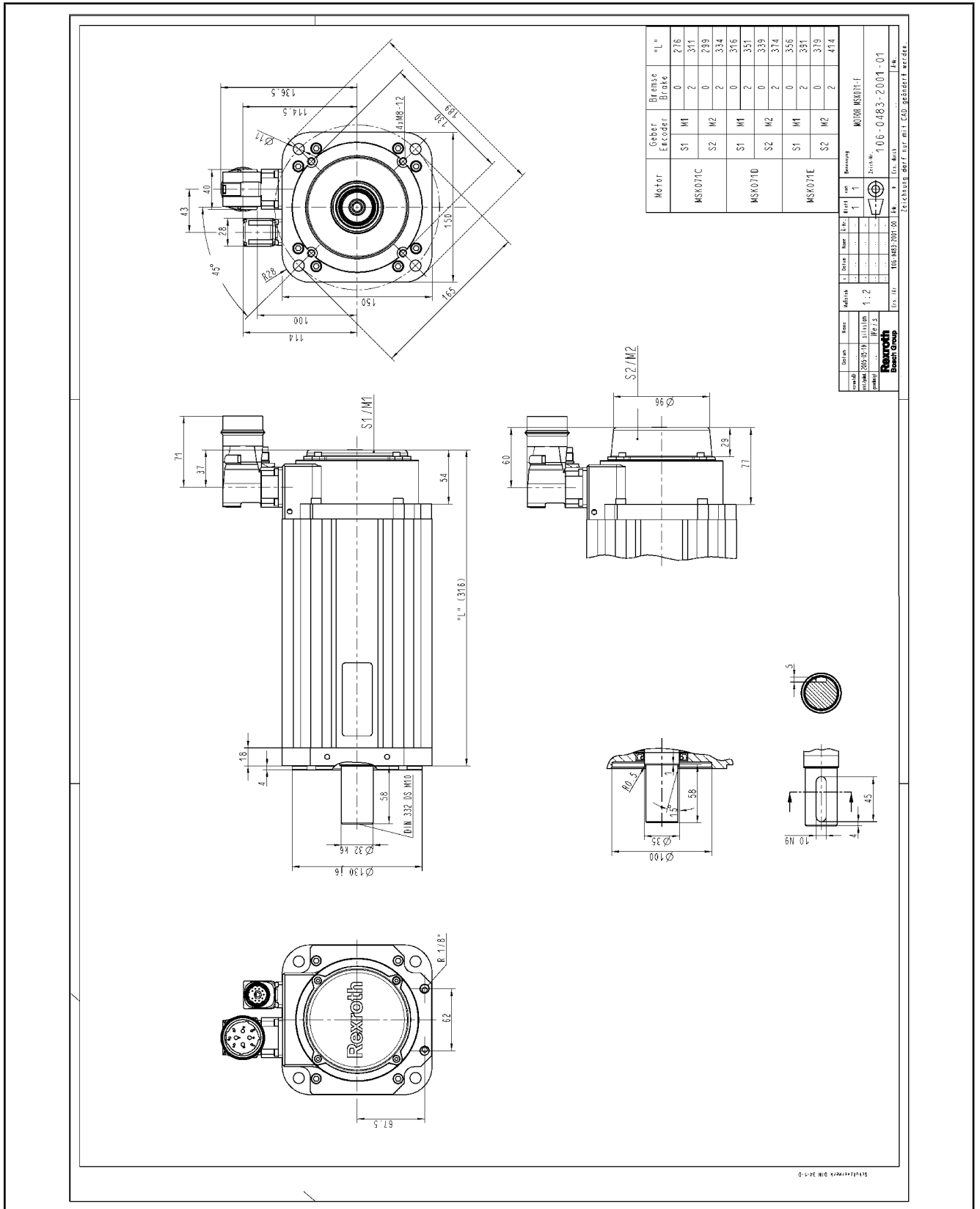

Fig.5-10: MSK071...FN specification

Specifications

5.10 MSK075 Specifications

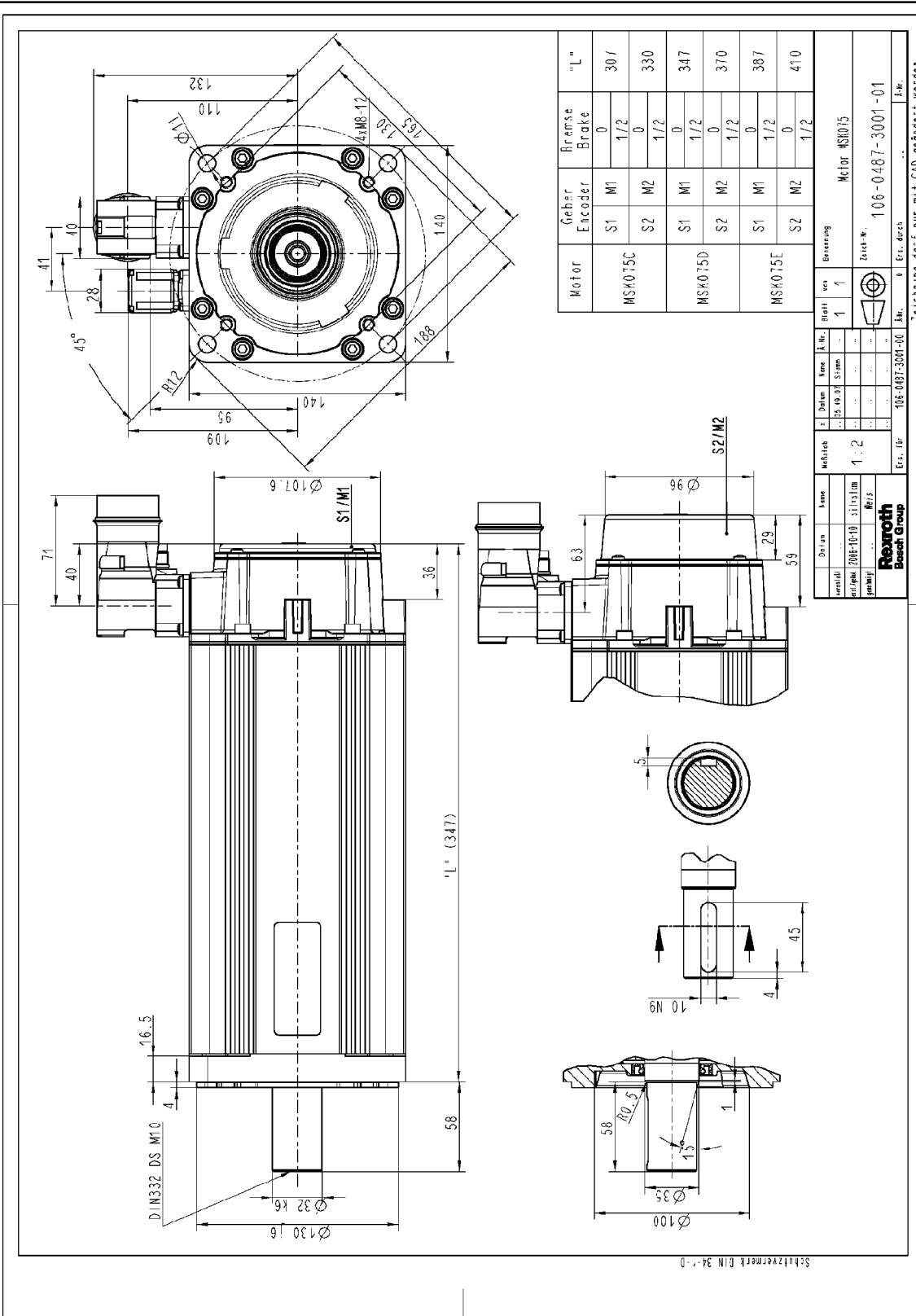

Fig.5-11: MSK075...NN specification

5.11 MSK075 Specifications Liquid Cooling

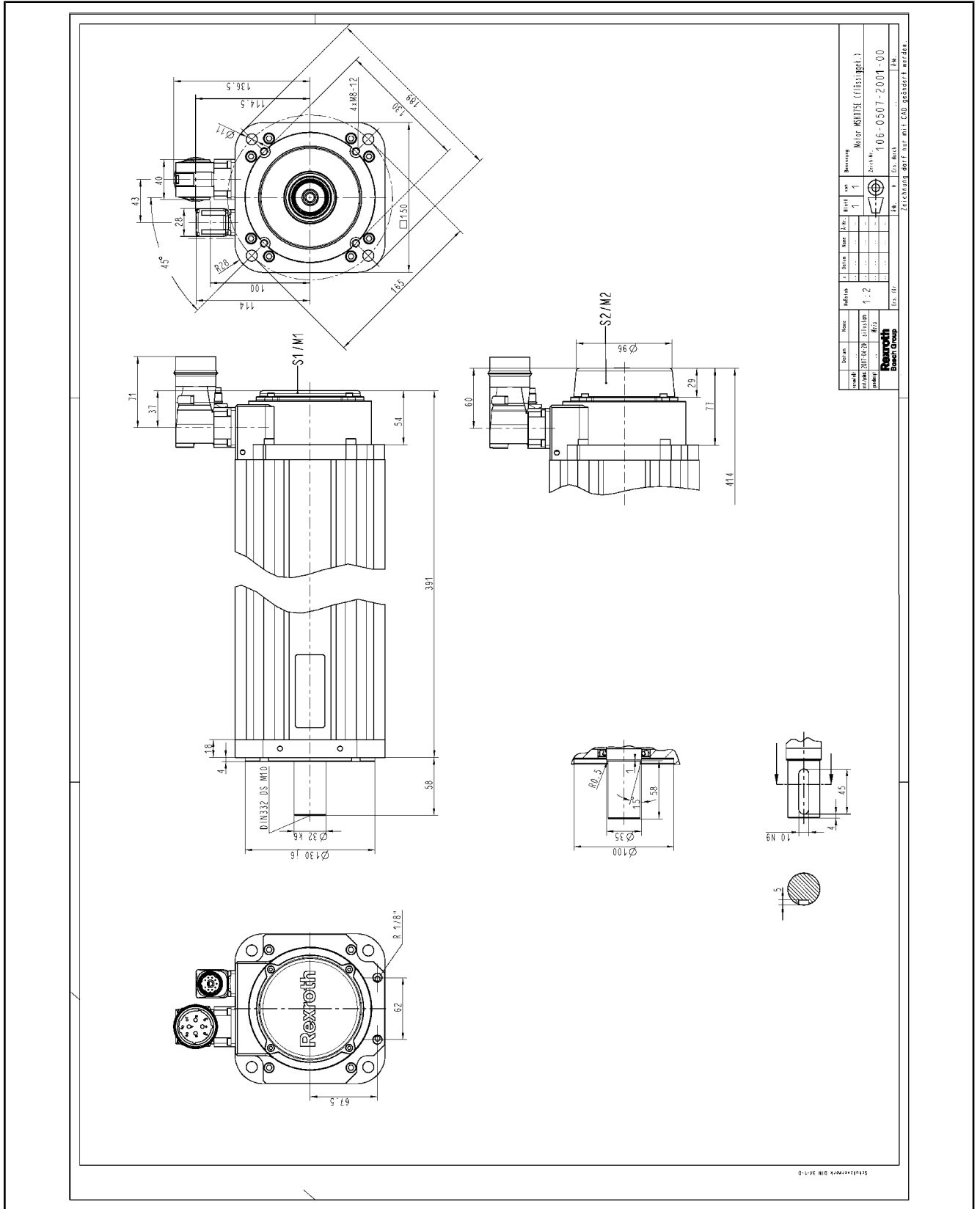

Fig.5-12: MSK075...FN specification

Specifications

5.12 MSK076 Specifications

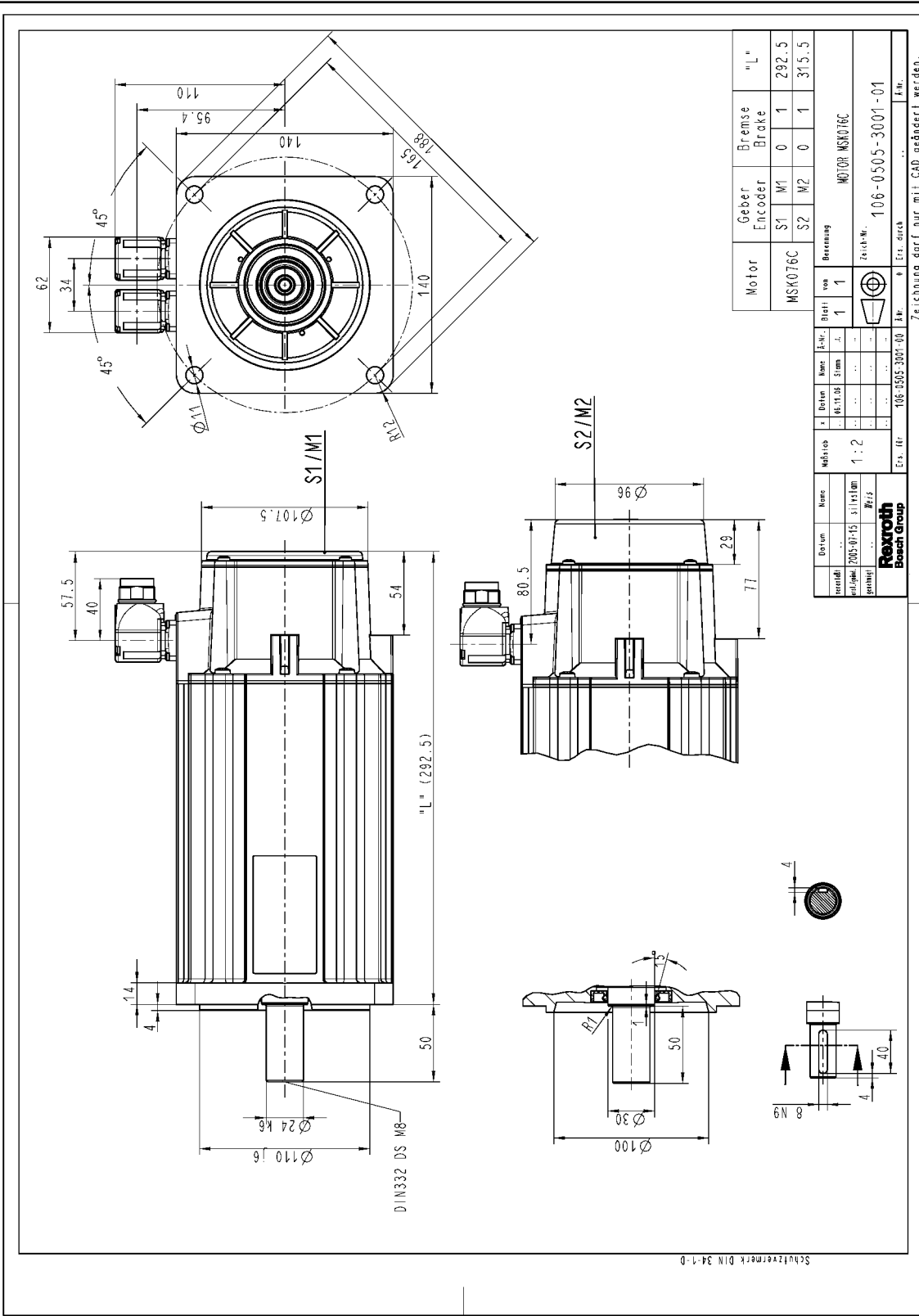

Fig.5-13: MSK076 specification

5.13 MSK100 Specifications

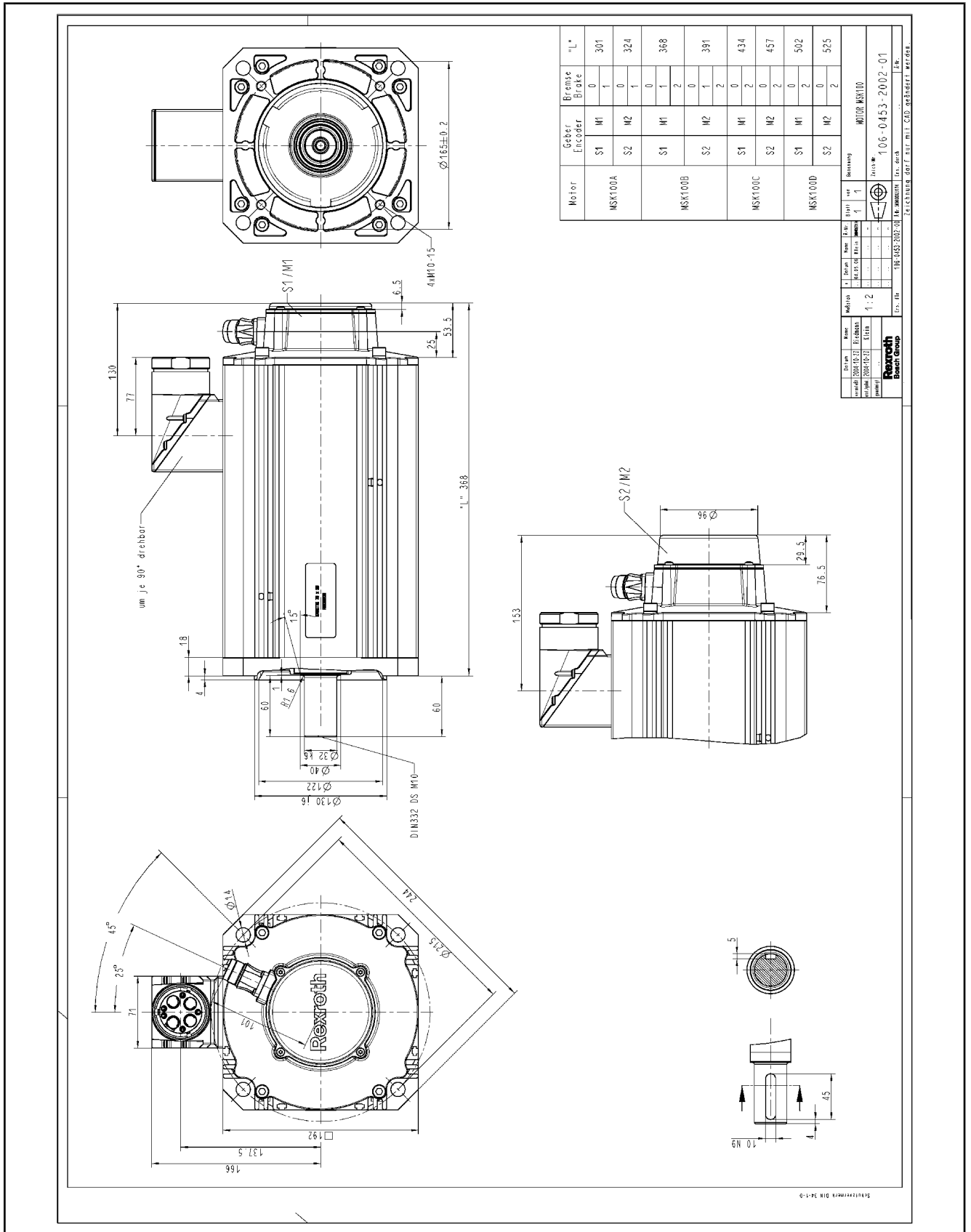

Fig. 5-14: MSK100 specification

Specifications

5.14 MSK101 Specifications

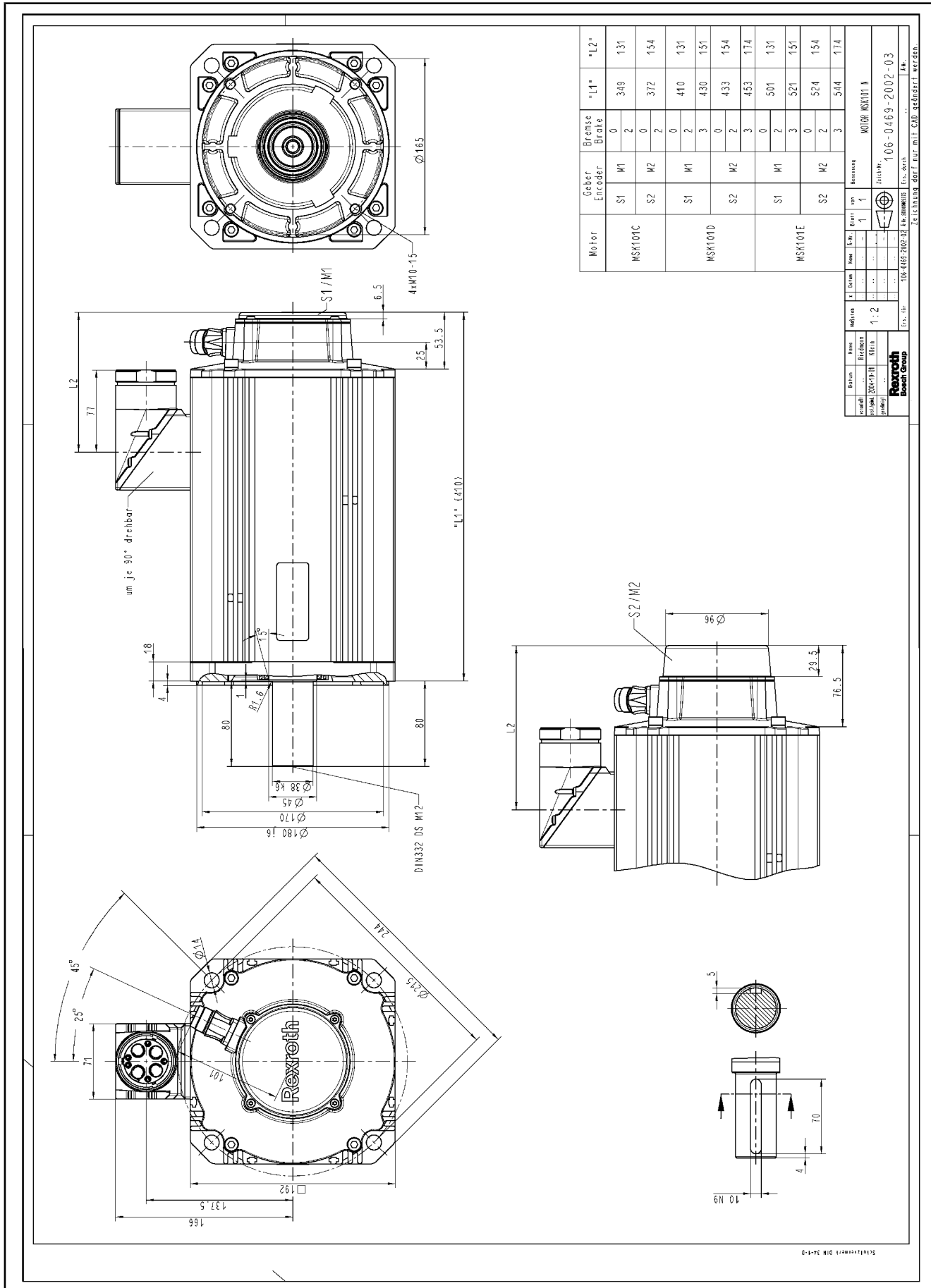

Fig.5-15: MSK101 specification

5.15 MSK101 Specifications Liquid Cooling

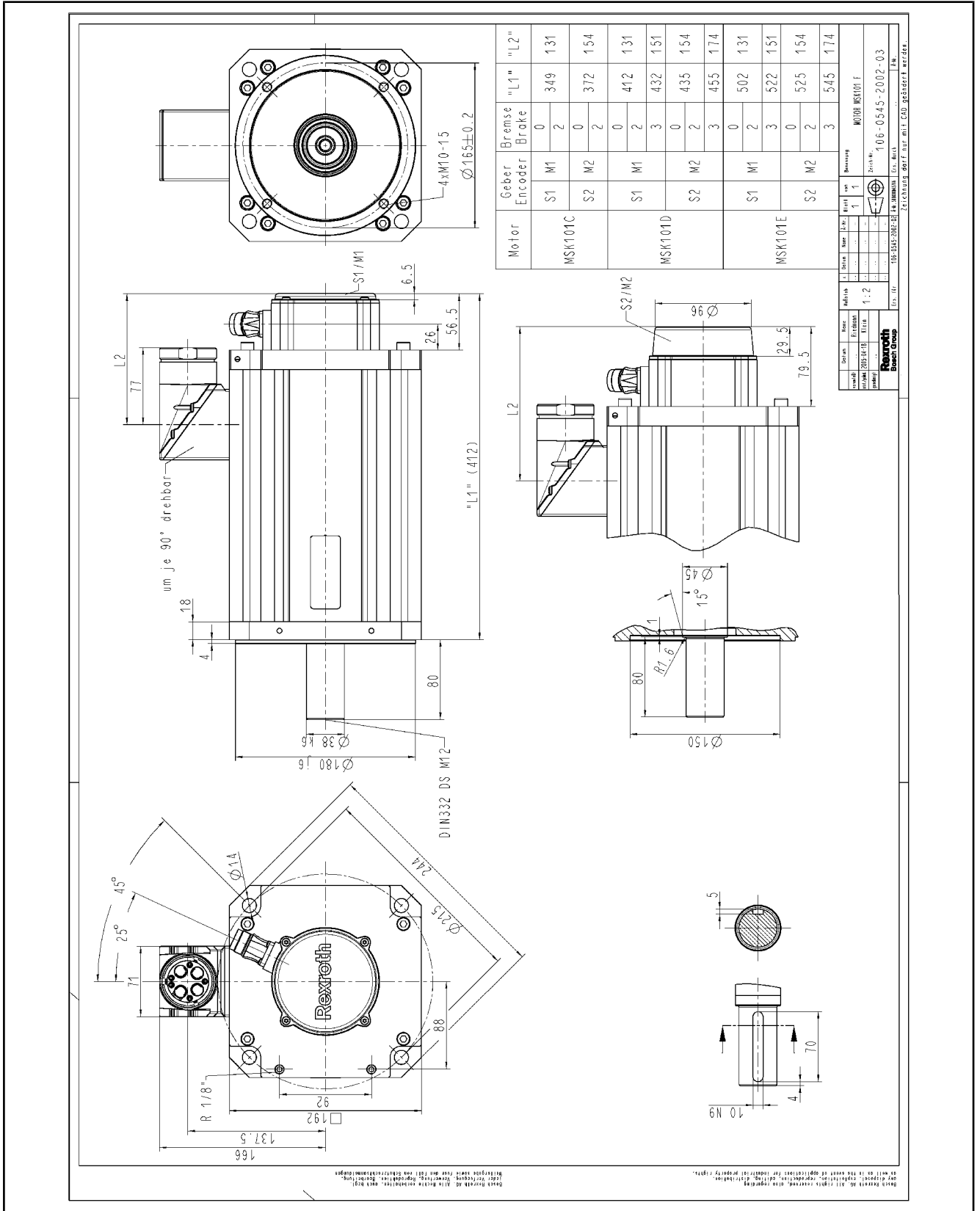

Fig.5-16: MSK101...FN specification

Specifications

5.16 MSK103 Specifications

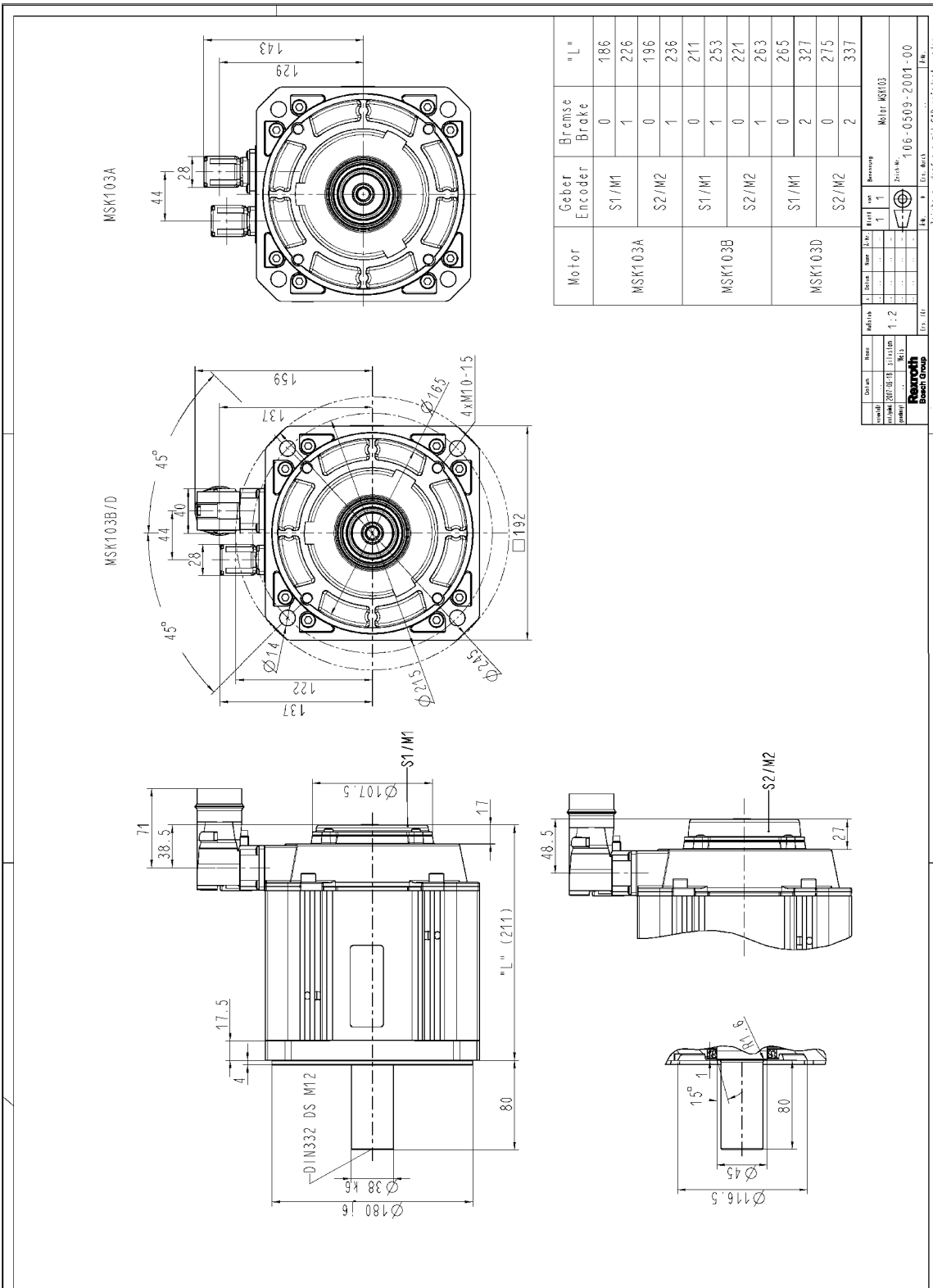

Fig.5-17: MSK103 specification

5.17 MSK131 Specifications

The technical drawings show the MSK131 motor from multiple perspectives. The side view includes dimensions for the motor housing (L1, L2, L3), bearing positions (B1, B2), and mounting feet. The front view shows the motor's circular profile with mounting holes and a central shaft. Detail views show the shaft diameter ($\varnothing 26$), encoder connection, and mounting foot details.

Motor	Geber Encoder	Brake Broke	"L1"	"L2"	"L3"
MSK131B	S1 M1	0	470	175	160
	S2 M2	1	470	180	160
MSK131D	S1 M1	0	610	235	233
	S2 M2	1	610	260	233

Material	Address	Reichweite	Druck	Druckklasse	Druckwert
MSK131	1, 2				106-0566-2002-00

0-1-PE MID 43994131015

Fig.5-18: MSK131 specification

6 Type Codes

6.1 MSK Type Code - Structure and Description

General Information Each order of a Rexroth product must be based on the type code. All available motor variants are uniquely described by their type code. The individual characters of the type code (abbrev. column) and their meaning are described below.



- The sections below are numbered according to the numbering of the individual type codes.
- Before ordering, please check the availability of the separate options with your Bosch Rexroth sales partner.

Product MSK three-digit Rexroth-specific designation of a servomotor series.

Frame Size The motor frame size determines important mechanical motor specifications and is proportional to the performance variables.

Frame Length Within a series, the graduation of the increasing motor frame length is indicated by ID letters in alphabetic order. Frame lengths are, for example, B, C, D and E.

Winding The four-digit sequence of figures identifies the rated speed applicable for the respective type of winding.

Cooling Mode	Option	Design	Detail
	NN	Natural Convection	Fan mounting possible ¹⁾
	FN	Liquid cooling	Standard connection for coolant ducts 1/8", fan mounting not possible

1) Not admissible for ATEX version

Fig. 6-1: Cooling modes for IndraDyn S motors

Encoder IndraDyn S motors are equipped with an integrated encoder system. To control the motor speed and / or to position the motor, the drive control device must know the current motor position.

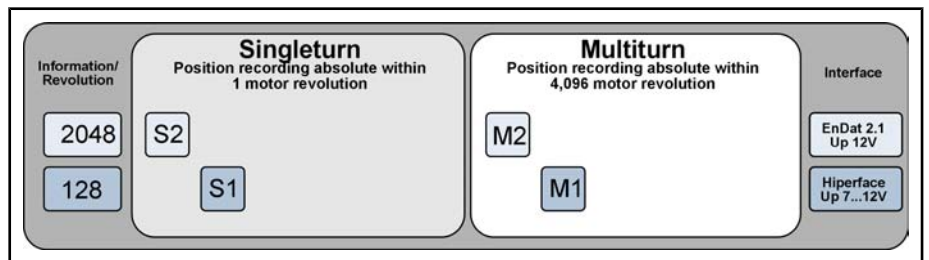
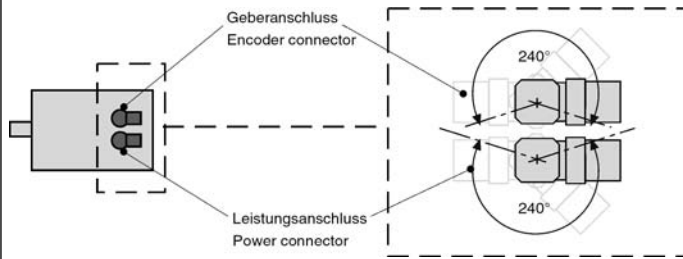

Fig. 6-2: IndraDyn S motor encoders

Type Codes

Electrical Connection

Option	Description
U ¹⁾	Rotating power and encoder connector 
A ²⁾	Power connector, side A
B ²⁾	Power connector, side B
L ²⁾	Power connector, to the left
R ²⁾	Power connector, to the right

1) for MSK030, -040, -050, -060, -070, -071, -076, -103 motors

2) for MSK100, -101, -131 motors

Fig.6-3: IndraDyn S connectors with fixed output direction

Drive Shaft

In order to connect the machine elements to be driven to the motor drive shafts, the following options are available for all IndraDyn S motors:

Option	Design	Detail
G	Plain shaft	With frontal centering hole with "DS" thread according to DIN 332, Part 2, Edition 05.83
P	Shaft with keyway ¹⁾	
1) Keyway according to DIN 6885, sheet 1, ed. 08.68. For details, refer to the dimension sheets.		

Fig.6-4: IndraDyn S output shafts



IndraDyn S motors are balanced with a key. The related key is not included in the scope of delivery.

Holding Brake

As an option, IndraDyn S motors are available with electrically releasing holding brakes with various holding torques.

Option	Holding Brakes	
0	Without holding brake	
1, 2, 3	With holding brake	The holding torques are indicated in the motor type code.

Fig.6-5: IndraDyn S holding brakes



The holding brake is not suitable for the protection of personnel or as a service brake! Please also observe the installation and safety instructions on the motor holding brakes in the chapter entitled "Application Notes".

Design

NNNN = standard design

NSNN = standard and explosion protection design according to equipment group II, categories 3G and 3D according to DIN EN 60079 et seqq.

RNNN = design with increased concentricity

Type Codes

RSNN = design with increased concentricity and explosion protection design according to equipment group II, categories 3G and 3D according to DIN EN 60079 et seqq.

Reference to Standards The item "Reference to Standards" indicates standards referred to in the type code (e.g. DIN, EN, ISO, etc.) or factory standards (RNC ...) that are also applicable. The version listed is always that valid at the time the type code is issued.

Comment Please refer to this item for additionally required information concerning the handling of the type code. This includes, for example, descriptions on footnotes or notes on availability.

Type Codes

6.2 MSK030 Type Code

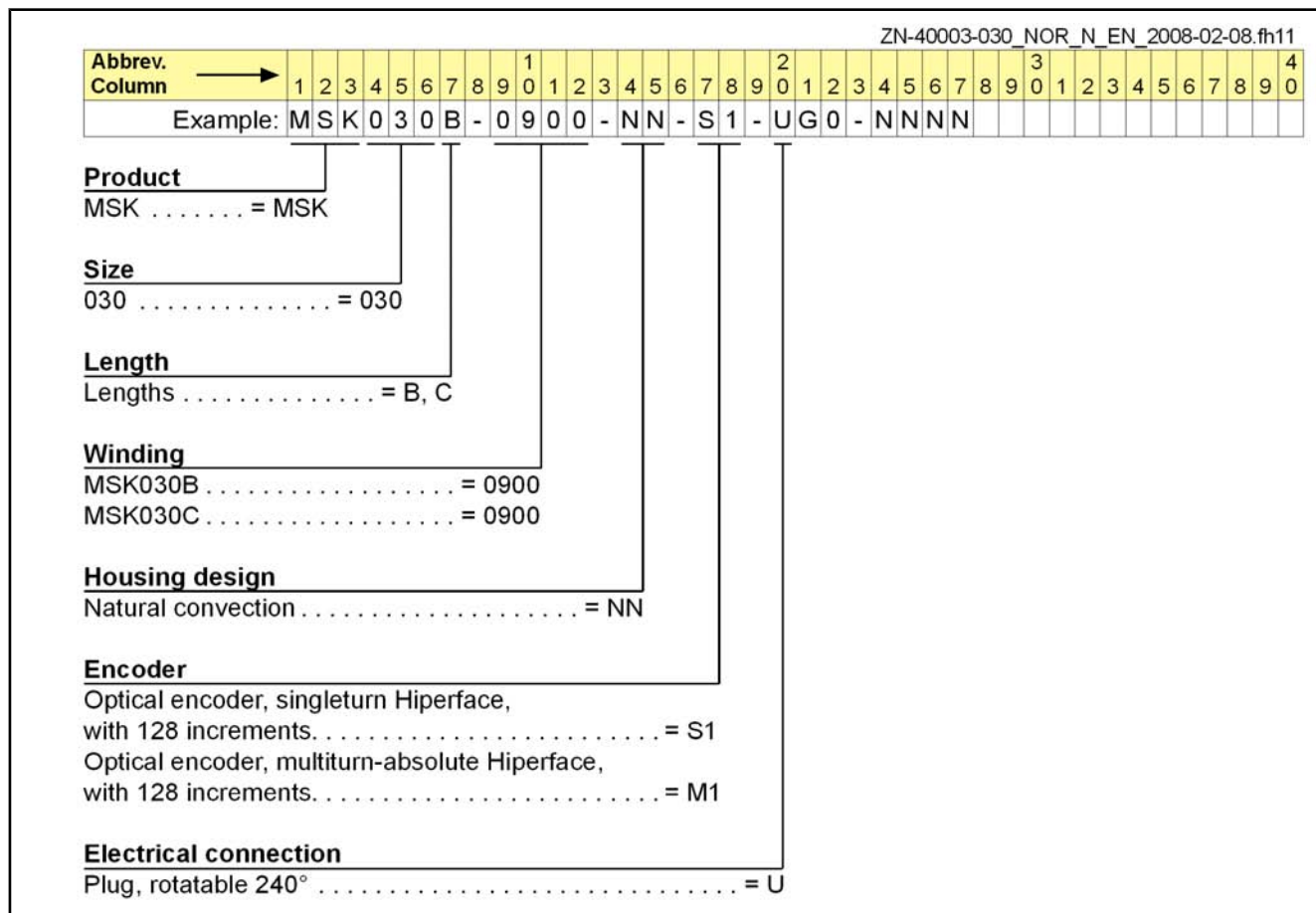

Fig.6-6: MSK030 type code (page 1)

ZN-40003-030 NOR_N_EN_2008-02-08.fh11

Abbrev. Column	1	2	3	4	5	6	7	8	9	0	1	2	3	4	5	6	7	8	9	0	1	2	3	4	5	6	7	8	9	0	1	2	3	4	5	6	7	8	9	0						
Example:	M	S	K	0	3	0	B	-	0	9	0	0	-	N	N	-	S	1	-	U	G	0	-	N	N	N	N																			

Shaft			
Plain shaft with shaft sealing ring (standard).....	= G		
Shaft with keyway per DIN 6885-1 with shaft sealing ring...	= P		
Holding brake			
Without holding brake	= 0		
Holding brake, electrical release, 1 Nm.....	= 1		
Other design			
Standard.....	= NNNN		
Standard and Ex type for cluster II, categories 3G and 3D on DIN EN 60079 ff	= NSNN		
Standard reference			
Standard	Edition	Title	
DIN 6885-1	1968-08	Drive Type Fastenings without Taper Action; Parallel Keys, Keyways, Deep Patter	
DIN EN 60079 ff	-		
		Electrical apparatus for explosive gas atmospheres (ATEX)	

Fig.6-7: MSK030 type code (page 2)

Type Codes

6.3 MSK040 Type Code

ZN-40003-040_NOR_N_EN_2007-02-14.fh11

Abbrev. Column	1	2	3	4	5	6	7	8	9	0	1	2	3	4	5	6	7	8	9	0	1	2	3	4	5	6	7	8	9	0	
Example:	M	S	K	0	4	0	B	-	0	6	0	0	-	N	N	-	S	1	-	U	G	0	-	N	N	N	N				

Product
MSK = MSK

Size
040 = 040

Length
Lengths = B, C

Winding
MSK040B = 0450, 0600
MSK040C = 0450, 0600

Cooling mode
Natural convection = NN

Encoder
Optical encoder, singleturn hiperface, with 128 increments = S1
Optical encoder, multifurn hiperface, with 128 increments = M1

Electrical connection
Plug, rotatable 240° = U

Shaft
Plain shaft with shaft sealing ring (standard) = G
Shaft with key per DIN 6885-1 with shaft sealing ring = P

Holding brake
Without holding brake = 0
Holding brake, electrically-released, 4 Nm = 1

Fig.6-8: MSK040 type code (page 1)

ZN-40003-040_NOR_N_EN_2007-02-14.fh11

Abbrev. Column	1	2	3	4	5	6	7	8	9	0	1	2	3	4	5	6	7	8	9	0	1	2	3	4	5	6	7	8	9	0			
Example:	M	S	K	0	4	0	B	-	0	6	0	0	-	N	N	-	S	1	-	U	G	0	-	N	N	N	N						

Other design

Standard..... = NNNN
 Standard and Ex type for cluster II, categories 3G and 3D
 on DIN EN 60079 ff = NSNN

Standard reference

Standard	Title	Edition
DIN 6885-1	1968-08	Drive Type Fastenings without Taper Action; Parallel Keys, Keyways, Deep Pattern
DIN EN 60079 ff	-	Electrical apparatus for explosive gas atmospheres (ATEX)

Fig. 6-9: MSK040 type code (page 2)

Type Codes

6.4 MSK050 Type Code

ZN-40003-050_NOR_N_EN_2008-02-08.fh11

Abbrev. Column	→	1	2	3	4	5	6	7	8	9	1	0	1	2	3	4	5	6	7	8	9	2	0	1	2	3	4	5	6	7	8	9	3	0	1	2	3	4	5	6	7	8	9	4	0
Example:		M	S	K	0	5	0	C	-	0	6	0	0	-	N	N	-	S	1	-	U	G	0	-	N	N	N	N																	

Product
MSK = MSK

Size
050 = 050

Length
Lengths = B, C

Winding
MSK050B = 0300, 0450, 0600
MSK050C = 0300, 0450, 0600

Housing design
Natural convection = NN

Encoder
Optical encoder, singleturn Hiperface,
with 128 increments. = S1
Optical encoder, singleturn EnDat2.1,
with 2048 increments. = S2
Optical encoder, multiturn-absolute Hiperface,
with 128 increments. = M1
Optical encoder, multiturn-absolute EnDat2.1,
with 2048 increments. = M2

Electrical connection
Plug, rotatable 240° = U

Fig.6-10: MSK050 type code (page 1)

ZN-40003-050_NOR_N_EN_2008-02-08.fh11

Abbrev.	1	2	3	4	5	6	7	8	9	0	1	2	3	4	5	6	7	8	9	0	1	2	3	4	5	6	7	8	9	0	1	2	3	4	5	6	7	8	9	0														
Column																					1											2											3											4
Example:	M	S	K	0	5	0	C	-	0	6	0	0	-	N	N	-	S	1	-	U	G	0	-	N	N	N	N																											

Shaft
Plain shaft with shaft sealing ring (standard) = G
Shaft with keyway per DIN 6885-1 with shaft sealing ring. . . = P

Holding brake
Without holding brake = 0
Holding brake, electrical release, 6 Nm. = 1

Other design ①
Standard. = NNNN
Standard and Ex type for cluster II, categories 3G and 3D
on DIN EN 60079 ff = NSNN
Reduced shaft run-out, axial run-out according to DIN 42955. . . = RNNN
Reduced shaft run-out, axial run-out according to DIN 42955 and
Ex type for cluster II, categories 3G and 3D on DIN EN 60079 ff = RSNN

Note:
① Other design "NNNN" and "NSNN" are only available with encoder "S1" and "M1"
Other design "RNNN" and "RSNN" are only available with encoder "S2" and "M2"

Standard reference

Standard	Edition	Title
DIN 6885-1	1968-08	Drive Type Fastenings without Taper Action; Parallel Keys, Keyways, Deep Patter
DIN 42955	1981-12	Tolerances of shaft extension run-out of mounting flanges for rotating electrical machinery, test
DIN EN 60079 ff	-	Electrical apparatus for explosive gas atmospheres (ATEX)

Fig.6-11: MSK050 type code (page 2)

Type Codes

6.5 MSK060 Type Code

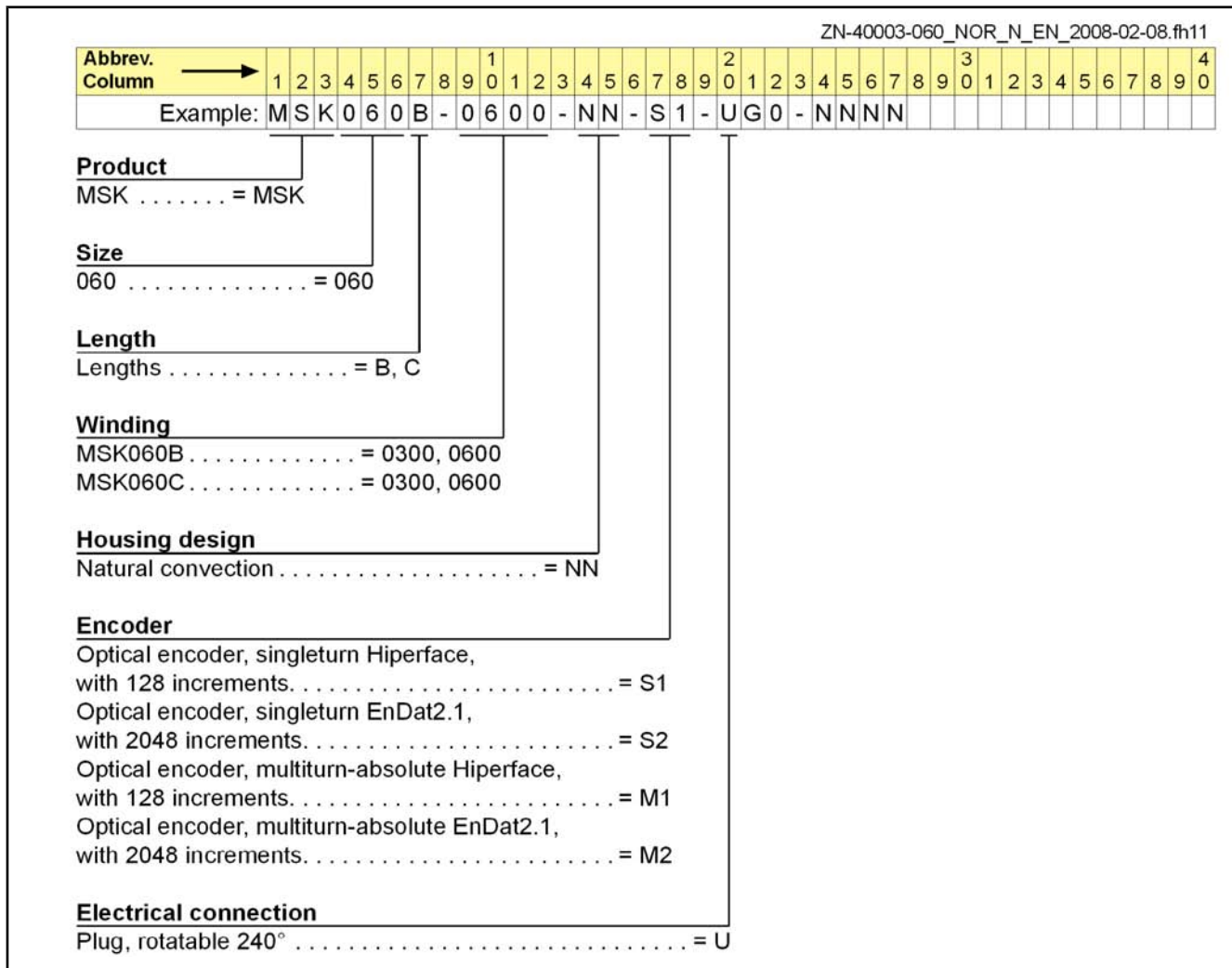

Fig. 6-12: MSK060 type code (page 1)

ZN-40003-060 NOR_N_EN_2008-02-08.fh11

Abbrev.																																											
Column →	1	2	3	4	5	6	7	8	9	0	1	2	3	4	5	6	7	8	9	0	1	2	3	4	5	6	7	8	9	0	1	2	3	4	5	6	7	8	9	0			
Example:	M	S	K	0	6	0	B	-	0	6	0	0	-	N	N	-	S	1	-	U	G	0	-	N	N	N	N																

Shaft
 Plain shaft with shaft sealing ring (standard) = G
 Shaft with keyway per DIN 6885-1 with shaft sealing ring. . . = P

Holding brake
 Without holding brake = 0
 Holding brake, electrical release, 10 Nm. = 1

Other design ①
 Standard. = NNNN
 Standard and Ex type for cluster II, categories 3G and 3D on DIN EN 60079 ff = NSNN
 Reduced shaft run-out, axial run-out according to DIN 42955. . . = RNNN
 Reduced shaft run-out, axial run-out according to DIN 42955 and Ex type for cluster II, categories 3G and 3D on DIN EN 60079 ff = RSNN

Note:
 ① Other design "NNNN" and "NSNN" are only available with encoder "S1" and "M1"
 Other design "RNNN" and "RSNN" are only available with encoder "S2" and "M2"

Standard reference

Standard	Edition	Title
DIN 6885-1	1968-08	Drive Type Fastenings without Taper Action; Parallel Keys, Keyways, Deep Patter
DIN 42955	1981-12	Tolerances of shaft extension run-out of mounting flanges for rotating electrical machinery, test
DIN EN 60079 ff	-	Electrical apparatus for explosive gas atmospheres (ATEX)

Fig. 6-13: MSK060 type code (page 2)

Type Codes

6.6 MSK061 Type Code

ZN-40003-061_NOR_N_EN_2008-05-21.fh11

Abbrev. Column		1	2	3	4	5	6	7	8	9	0	1	2	3	4	5	6	7	8	9	0	1	2	3	4	5	6	7	8	9	0	1	2	3	4	5	6	7	8	9	0				
Example:		M	S	K	0	6	1	C	-	0	3	0	0	-	N	N	-	S	1	-	U	G	0	-	N	N	N	N																	

Product
MSK = MSK

Size
061..... = 061

Length ¹
Lengths = B, C

Winding code
MSK061B = 0300
MSK061C = 0200, 0300, 0600

Cooling mode
Natural convection = NN

Encoder
Optical encoder, singleturn Hiperface, with 128 increments. = S1
Optical encoder, singleturn EnDat2.1, with 2048 increments. = S2
Optical encoder, multiturn-absolute Hiperface, with 128 increments. = M1
Optical encoder, multiturn-absolute EnDat2.1, with 2048 increments. = M2

Electrical connection
Plug, rotatable 240° = U

Shaft
Plain shaft with shaft sealing ring (standard)..... = G
Shaft with keyway per DIN 6885-1 with shaft sealing ring. . . = P

Fig. 6-14: MSK061 type code (page 1)

Type Codes

6.7 MSK070 Type Code

ZN-40003-070_NOR_N_EN_2008-02-08.fh11

Abbrev. Column	1	2	3	4	5	6	7	8	9	0	1	2	3	4	5	6	7	8	9	0	1	2	3	4	5	6	7	8	9	0	4		
Example:	M	S	K	0	7	0	C	-	0	4	5	0	-	N	N	-	S	1	-	U	G	0	-	N	N	N	N						

Product
MSK = MSK

Size
070 = 070

Length
Lengths. = C, D, E

Winding
MSK070C = 0150, 0300, 0450
MSK070D = 0150, 0300, 0450
MSK070E = 0150, 0300, 0450

Housing design
Natural convection = NN

Encoder
Optical encoder, singleturn Hiperface, with 128 increments. = S1
Optical encoder, singleturn EnDat2.1, with 2048 increments. = S2
Optical encoder, multiturn-absolute Hiperface, with 128 increments. = M1
Optical encoder, multiturn-absolute EnDat2.1, with 2048 increments. = M2

Electrical connection
Plug, rotatable 240° = U

Fig.6-16: MSK070 type code (page 1)

ZN-40003-070 NOR_N_EN_2008-02-08.fh11

Abbrev. Column	1	2	3	4	5	6	7	8	9	1	2	3	4	5	6	7	8	9	0	1	2	3	4	5	6	7	8	9	0	1	2	3	4	5	6	7	8	9	0	
Example:	M	S	K	0	7	0	C	-	0	4	5	0	-	N	N	-	S	1	-	U	G	0	-	N	N	N	N													

Shaft
 Plain shaft with shaft sealing ring (standard) = G
 Shaft with keyway per DIN 6885-1 with shaft sealing ring. . . = P

Holding brake
 Without holding brake = 0
 Holding brake, electrical release, 23 Nm. = 1

Other design ①
 Standard. = NNNN
 Standard and Ex type for cluster II, categories 3G and 3D
 on DIN EN 60079 ff = NSNN
 Reduced shaft run-out, axial run-out according to DIN 42955. . . = RNNN
 Reduced shaft run-out, axial run-out according to DIN 42955 and
 Ex type for cluster II, categories 3G and 3D on DIN EN 60079 ff = RSNN

Note:
 ① Other design "NNNN" and "NSNN" are only available with encoder "S1" and "M1"
 Other design "RNNN" and "RSNN" are only available with encoder "S2" and "M2"

Standard reference

Standard	Edition	Title
DIN 6885-1	1968-08	Drive Type Fastenings without Taper Action; Parallel Keys, Keyways, Deep Patter
DIN 42955	1981-12	Tolerances of shaft extension run-out of mounting flanges for rotating electrical machinery, test
DIN EN 60079 ff	-	Electrical apparatus for explosive gas atmospheres (ATEX)

Fig. 6-17: MSK070 type code (page 2)

Type Codes

6.8 MSK071 Type Code

ZN-40003-071_NOR_E_EN_2007-05-10.fh11

Abbrev. Column	1	2	3	4	5	6	7	8	9	0	1	2	3	4	5	6	7	8	9	0	1	2	3	4	5	6	7	8	9	0	
Example:	M	S	K	0	7	1	D	-	0	3	0	0	-	N	N	-	S	1	-	U	G	0	-	N	N	N	N				

Product
MSK = MSK

Size
071..... = 071

Length
Lengths = C, D, E

Winding
MSK071C = 0200, 0300, 0450
MSK071D = 0200, 0300, 0450
MSK071E = 0200, 0300, 0450

Cooling mode
Liquid cooling = FN 1
Natural convection = NN

Encoder
Optical encoder, singleturn Hiperface,
with 128 increments. = S1
Optical encoder, singleturn EnDat2.1,
with 2048 increments. = S2
Optical encoder, multiturn-absolute Hiperface,
with 128 increments. = M1
Optical encoder, multiturn-absolute EnDat2.1,
with 2048 increments. = M2

Electrical connection
Plug, rotatable 240° = U

Fig.6-18: MSK071 type code (page 1)

Abbrev. Column	1	2	3	4	5	6	7	8	9	10	11	12	13	14	15	16	17	18	19	20	21	22	23	24	25	26	27	28	29	30	
Example:	M	S	K	0	7	1	D	-	0	3	0	0	-	N	N	-	S	1	-	U	G	0	-	N	N	N	N				

ZN-40003-071_NOR_E_EN_2007-05-10.fh11

Shaft
Plain shaft with shaft sealing ring (standard). = G
Shaft with keyway per DIN 6885-1 with shaft sealing ring. . . = P

Holding brake
Without holding brake = 0
Holding brake, electrically-released, 23 Nm = 1
Holding brake, electrically-released, 30 Nm = 2

Other design ②
Standard. = NNNN
Standard and Ex type for cluster II, categories 3G and 3D
on DIN EN 60079 ff = NSNN
Reduced shaft run-out, axial run-out according to DIN 42955. . . = RNNN
Reduced shaft run-out, axial run-out according to DIN 42955 and
Ex type for cluster II, categories 3G and 3D on DIN EN 60079 ff = RSNN

Note:
① Cooling mode "FN" is only available with holding brake "0" and "2"
② Other design "NNNN" and "NSNN" are only available with encoder "S1" and "M1"
Other design "RNNN" and "RSNN" are only available with encoder "S2" and "M2"

Standard reference

Standard	Edition	Title
DIN 6885-1	1968-08	Drive Type Fastenings without Taper Action; Parallel Keys, Keyways, Deep Patter
DIN 42955	1981-12	Tolerances of shaft extension run-out of mounting flanges for rotating electrical machinery, test
DIN EN 60079 ff	-	Electrical apparatus for explosive gas atmospheres (ATEX)

Fig.6-19: MSK071 type code (page 2)

Type Codes

6.9 MSK075 Type Code

ZN-40003-075_NOR_E_EN_2007-07-26.flh11

Abbrev. Column	→	1										2										3										4														
1	2	3	4	5	6	7	8	9	0	1	2	3	4	5	6	7	8	9	0	1	2	3	4	5	6	7	8	9	0	1	2	3	4	5	6	7	8	9	0							
Example:		M	S	K	0	7	5	E	-	0	2	0	0	-	N	N	-	S	2	-	U	G	1	-	R	N	N	N																		

Product
MSK = MSK

Size
075..... = 075

Length
Lengths = C, D, E

Winding
MSK075C = 0200, 0300, 0450
MSK075D = 0200, 0300, 0450
MSK075E = 0200, 0300, 0450

Cooling mode
Liquid cooling..... = FN ❶
Natural convection..... = NN

Encoder
Optical encoder, singleturn Hiperface, with 128 increments..... = S1
Optical encoder, singleturn EnDat2.1, with 2048 increments..... = S2
Optical encoder, multiturn-absolute Hiperface, with 128 increments..... = M1
Optical encoder, multiturn-absolute EnDat2.1, with 2048 increments..... = M2

Electrical connection
Plug, rotatable 240° = U

Fig. 6-20: MSK075 type code (page 1)

ZN-40003-075_NOR_E_EN_2007-07-26.fh11

Abbrev. Column	1	2	3	4	5	6	7	8	9	1	2	3	4	5	6	7	8	9	2	1	2	3	4	5	6	7	8	9	3	1	2	3	4	5	6	7	8	9	4
Example:	M	S	K	0	7	5	E	-	0	2	0	0	-	N	N	-	S	2	-	U	G	1	-	R	N	N	N												

Shaft
 Plain shaft with shaft sealing ring (standard). = G
 Shaft with keyway per DIN 6885-1 with shaft sealing ring. . . = P

Holding brake
 Without holding brake = 0
 Holding brake, electrically-released, 23 Nm = 1
 Holding brake, electrically-released, 30 Nm = 2

Other design ②
 None = NNNN
 Reduced shaft run-out, axial run-out according to DIN 42955 . . . = RNNN

Note:
 ① Cooling mode "FN" is only available with length "E" and winding "0300" and "0450"
 ② Other design "NNNN" is only available with encoder "S1" and "M1"
 Other design "RNNN" is only available with encoder "S2" and "M2"

Standard reference

Standard	Edition	Title
DIN 6885-1	1968-08	Drive Type Fastenings without Taper Action; Parallel Keys, Keyways, Deep Patter
DIN 42955	1981-12	Tolerances of shaft extension run-out of mounting flanges for rotating electrical machinery, test

Fig. 6-21: MSK075 type code (page 2)

Type Codes

6.10 MSK076 Type Code

ZN-40003-076_NOR_E_EN_2007-07-30.fh11

Abbrev. Column	1	2	3	4	5	6	7	8	9	1	2	3	4	5	6	7	8	9	2	0	1	2	3	4	5	6	7	8	9	3	0	1	2	3	4	5	6	7	8	9	4	0							
Example:	M	S	K	0	7	6	C	-	0	3	0	0	-	N	N	-	S	1	-	U	G	0	-	N	N	N	N																						

Product		
MSK	= MSK	
Motor size		
076.....	= 076	
Motor length		
Lengths	= C	
Winding code		
MSK076C	= 0300, 0450	
Cooling mode		
Natural convection	= NN	
Encoder		
Optical encoder, singleturn Hiperface, with 128 increments.	= S1	
Optical encoder, singleturn EnDat2.1, with 2048 increments.	= S2	
Optical encoder, multiturn-absolute Hiperface, with 128 increments.	= M1	
Optical encoder, multiturn-absolute EnDat2.1, with 2048 increments.	= M2	
Electrical connection		
Plug, rotatable 240°	= U	
Shaft		
Plain shaft with shaft sealing ring (standard)	= G	
Shaft with keyway per DIN 6885-1 with shaft sealing ring. ...	= P	

Fig.6-22: MSK076 type code (page 1)

ZN-40003-076_NOR_E_EN_2007-07-30.fn11

Abbrev. Column	1	2	3	4	5	6	7	8	9	1	2	3	4	5	6	7	8	9	2	1	2	3	4	5	6	7	8	9	3	1	2	3	4	5	6	7	8	9	4	1	2	3	4	5	6	7	8	9	0
Example:	M	S	K	0	7	6	C	-	0	3	0	0	-	N	N	-	S	1	-	U	G	0	-	N	N	N	N																						

Holding brake

Without holding brake = 0

Holding brake, electrically-released, 11 Nm = 1

Other design ¹

Standard..... = NNNN

Standard and Ex type for cluster II, categories 3G and 3D
on DIN EN 60079 ff = NSNN

Reduced shaft run-out, axial run-out according to DIN 42955. . . . = RNNN

Reduced shaft run-out, axial run-out according to DIN 42955 and
Ex type for cluster II, categories 3G and 3D on DIN EN 60079 ff = RSNN

Note:

¹ Other design "NNNN" and "NSNN" are only available with encoder "S1" and "M1"
Other design "RNNN" and "RSNN" are only available with encoder "S2" and "M2"

Standard reference

Standard	Title	Edition
DIN 6885-1	1968-08	Drive Type Fastenings without Taper Action; Parallel Keys, Keyways, Deep Patter
DIN 42955	1981-12	Tolerances of shaft extension run-out of mounting flanges for rotating electrical machinery, test
DIN EN 60079 ff	-	Electrical apparatus for explosive gas atmospheres (ATEX)

Fig.6-23: MSK076 type code (page 2)

Type Codes

6.11 MSK100 Type Code

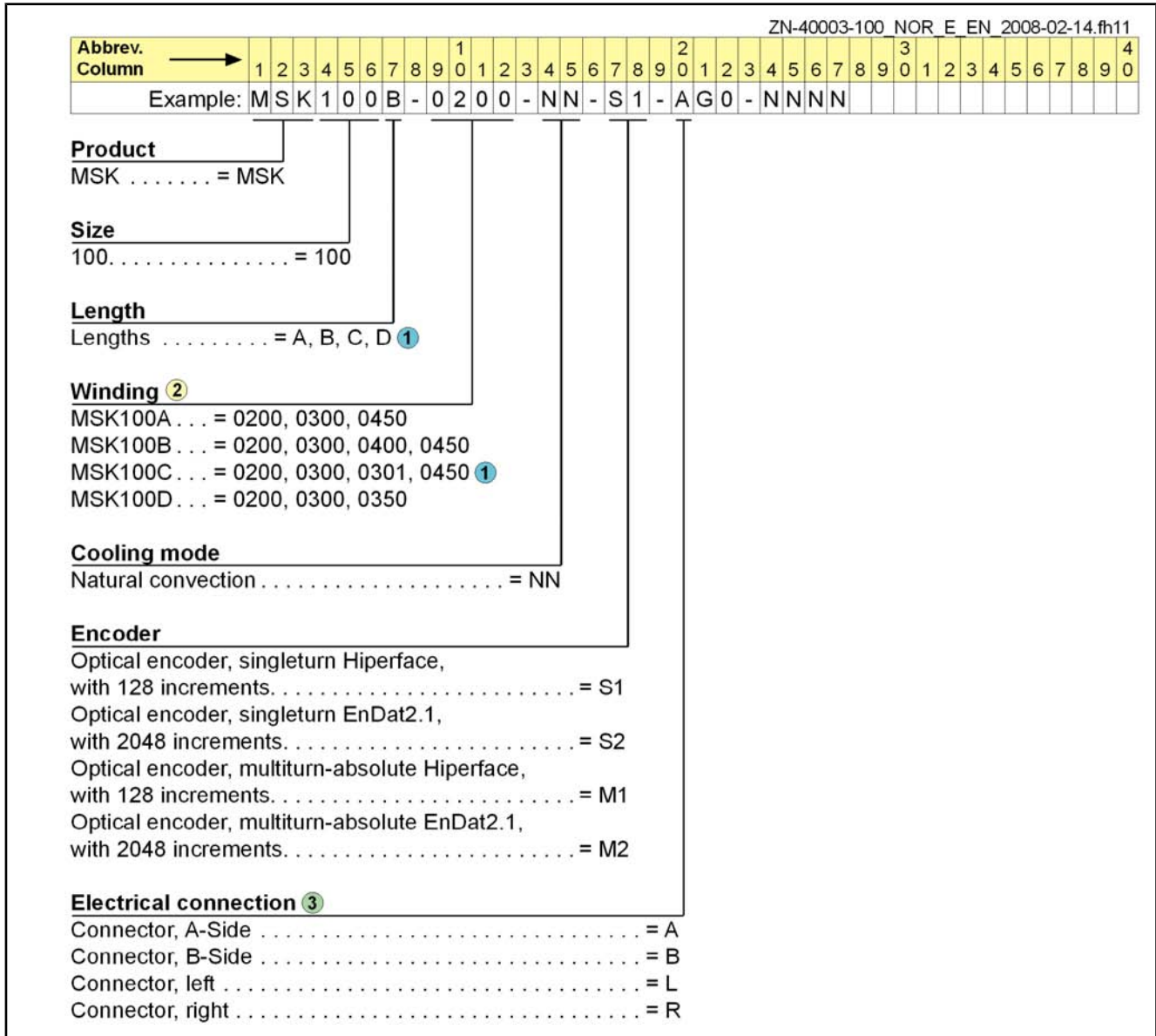

Fig.6-24: MSK100 type code (page 1)

Abbrev.	Column	1	2	3	4	5	6	7	8	9	1	2	3	4	5	6	7	8	9	0	2	1	2	3	4	5	6	7	8	9	0	3	1	2	3	4	5	6	7	8	9	0	4		
Example:		M	S	K	1	0	0	B	-	0	2	0	0	-	N	N	-	S	1	-	A	G	0	-	N	N	N	N																	

Shaft

Plain shaft with shaft sealing ring (standard) = G
 Shaft with keyway per DIN 6885-1 with shaft sealing ring. . . = P

Holding brake ④

Without holding brake. = 0
 Holding brake, electrically-released, 32 Nm = 1
 Holding brake, electrically-released, 70 Nm = 2

Other design ⑤

Standard. = NNNN
 Standard and Ex type for cluster II, categories 3G and 3D on DIN EN 60079 ff = NSNN
 Reduced shaft run-out, axial run-out according to DIN 42955. . . = RNNN
 Reduced shaft run-out, axial run-out according to DIN 42955 and Ex type for cluster II, categories 3G and 3D on DIN EN 60079 ff = RSNN

Note:

- ① Length "C" and winding "300" are only available with other design "NNNN" and "RNNN"
- ② Windings "0450" is only available with other design "NNNN" and "RNNN"
 Windings "0301" is only available with other design "NSNN" and "RSNN"
- ③ Looking from front onto driven shaft (see picture 1)
- ④ Holding brake "1" is only available with length "A" and "B"
 Holding brake "2" is not available with length "A"
- ⑤ Other design "NNNN" and "NSNN" are only available with encoder "S1" and "M1"
 Other design "RNNN" and "RSNN" are only available with encoder "S2" and "M2"

Illustration example

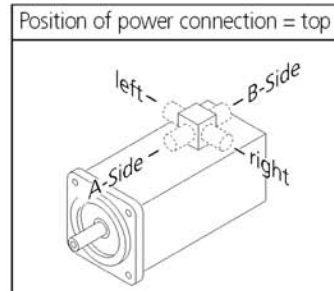
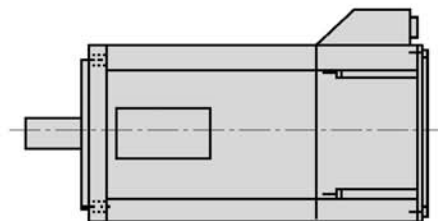

Picture 1

Standard reference

Standard	Edition	Title
DIN 6885-1	1968-08	Drive Type Fastenings without Taper Action; Parallel Keys, Keyways, Deep Patter
DIN 42955	1981-12	Tolerances of shaft extension run-out of mounting flanges for rotating electrical machinery, test
DIN EN 60079 ff	-	Electrical apparatus for explosive gas atmospheres (ATEX)

Fig. 6-25: MSK100 type code (page 2)

Type Codes

6.12 MSK101 Type Code

ZN-40003-101_NOR_N_EN_2008-02-27.fh11

Abbrev. Column	1	2	3	4	5	6	7	8	9	0	1	2	3	4	5	6	7	8	9	0	1	2	3	4	5	6	7	8	9	0	1	2	3	4	5	6	7	8	9	0				
Example:	M	S	K	1	0	1	D	-	0	2	0	0	-	N	N	-	S	1	-	A	G	0	-	N	N	N	N																	

Product
MSK = MSK

Size
101..... = 101

Length ¹
Lengths. = C, D, E

Winding ²
MSK101C ... = 0200, 0300, 0301, 0450
MSK101D ... = 0200, 0300, 0301, 0450
MSK101E ... = 0200, 0300, 0450

Cooling mode
Natural convection = NN
Liquid cooling = FN

Encoder
Optical encoder, singleturn Hiperface, with 128 increments. = S1
Optical encoder, singleturn EnDat2.1, with 2048 increments. = S2
Optical encoder, multiturn-absolute Hiperface, with 128 increments. = M1
Optical encoder, multiturn-absolute EnDat2.1, with 2048 increments. = M2

Electrical connection ³
Connector, A-Side = A
Connector, B-Side = B
Connector, left = L
Connector, right = R

Fig.6-26: MSK101 type code (page 1)

ZN-40003-101_NOR_N_EN_2008-02-27.fh11

Abbrev.	Column	1	2	3	4	5	6	7	8	9	1	2	3	4	5	6	7	8	9	2	1	2	3	4	5	6	7	8	9	3	0	1	2	3	4	5	6	7	8	9	0	4	
Example:	M S K 1 0 1 D - 0 2 0 0 - N N - S 1 - A G 0 - N N N N																																										

Shaft
Plain shaft with shaft sealing ring (standard) = G
Shaft with keyway per DIN 6885-1 with shaft sealing ring. . . = P

Holding brake ④
Without holding brake. = 0
Holding brake, electrically-released, 70 Nm = 2
Holding brake, electrically-released, 120 Nm = 3

Other design ⑤
Standard. = NNNN
Standard and Ex type for cluster II, categories 3G and 3D
on DIN EN 60079 ff = NSNN
Reduced shaft run-out, axial run-out according to DIN 42955. . . = RNNN
Reduced shaft run-out, axial run-out according to DIN 42955 and
Ex type for cluster II, categories 3G and 3D on DIN EN 60079 ff = RSNN

Note:

- ① Length "E" is only available with other design "NNNN" and "RNNN"
- ② Windings "0300" and "0450" are only available with other design "NNNN" and "RNNN"
Winding "0301" is only available with other design "NSNN" and "RSNN"
- ③ Looking from front onto driven shaft (see picture 1)
- ④ Holding brake "3" is not available with length "C"
- ⑤ Other design "NNNN" and "NSNN" are only available with encoder "S1" and "M1"
Other design "RNNN" and "RSNN" are only available with encoder "S2" and "M2"
Other design "NSNN" and "RSNN" are not available with cooling mode "FN" and holding brake "3"

Illustration example

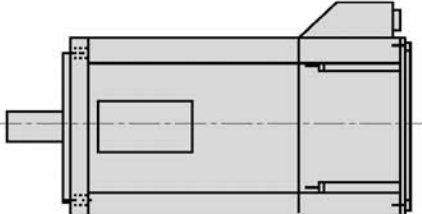

Position of power connection = top



Picture 1

Standard reference

Standard	Edition	Title
DIN 6885-1	1968-08	Drive Type Fastenings without Taper Action; Parallel Keys, Keyways, Deep Patter
DIN 42955	1981-12	Tolerances of shaft extension run-out of mounting flanges for rotating electrical machinery, test
DIN EN 60079 ff	-	Electrical apparatus for explosive gas atmospheres (ATEX)

Fig.6-27: MSK101 type code (page 2)

Type Codes

6.13 MSK103 Type Code

ZN-40003-103_NOR_N_EN_2008-02-08.fh11

Abbrev. Column	1	2	3	4	5	6	7	8	9	0	1	2	3	4	5	6	7	8	9	0	1	2	3	4	5	6	7	8	9	0	1	2	3	4	5	6	7	8	9	0	
Example:	M	S	K	1	0	3	B	-	0	3	0	0	-	N	N	-	S	1	-	U	G	0	-	N	N	N	N														

Product	MSK = MSK
Size	103..... = 103
Length	Lengths = A, B, D
Winding	MSK103A = 0300 MSK103B = 0300 MSK103D = 0300
Cooling mode	Natural convection = NN
Encoder	Optical encoder, singleturn Hiperface, with 128 increments = S1 Optical encoder, singleturn EnDat2.1, with 2048 increments = S2 Optical encoder, multiturn-absolute Hiperface, with 128 increments = M1 Optical encoder, multiturn-absolute EnDat2.1, with 2048 increments = M2
Electrical connection	Plug, rotatable 240° = U

Fig.6-28: MSK103 type code (page 1)

ZN-40003-103_NOR_N_EN_2008-02-08.fh11

Abbrev. Column	1	2	3	4	5	6	7	8	9	0	1	2	3	4	5	6	7	8	9	0	1	2	3	4	5	6	7	8	9	0	1	2	3	4	5	6	7	8	9	0							
Example:	M	S	K	1	0	3	B	-	0	3	0	0	-	N	N	-	S	1	-	U	G	0	-	N	N	N	N																				

Shaft
Plain shaft with shaft sealing ring (standard) = G

Holding brake ①
Without holding brake = 0
Holding brake, electrically-released, 33 Nm = 1
Holding brake, electrically-released, 60 Nm = 2

Other design
Standard. = NNNN

Note:
① Holding brake "1" is only available with length "A" and "B"
Holding brake "2" is only available with length "D"

Fig. 6-29: MSK103 type code (page 2)

7 Accessories and Options

7.1 Motor Encoder

7.1.1 General Information

To control the motor speed and/or to position the motor, the drive controller requires information on the current rotor position.

To achieve this, the integrated encoder unit makes the appropriate signals available to the drive control device. The drive control devices can transfer the position value determined in this manner to a superordinate controller.

The encoder electronics are equipped with a data memory where the motor type name, the control loop parameters and the motor parameters are filed. Rexroth drive control devices read out this data. This ensures

- quick and easy startup,
- adaptation between the motor and the drive control device without the risk of damage to the motor.

7.1.2 Technical Data of the Motor Encoder

Option	Encoder type	Measuring principle	System accuracy	Positioning acquisition mode	Position resolution on the motor
S1	Singleturn Hiperface optical encoder	Optical	±80 angular seconds	Absolute (more than 1 motor revolution)	128 x 2 ¹³ = 1,048,576 bits of information / motor revolution
M1	Optical encoder: Multiturn absolute Hiperface			Absolute (more than 4,096 motor revolutions)	
S2	Optical encoder: Singleturn EnDat 2.1	Optical	±20 angular seconds	Absolute (more than 1 motor revolution)	2048 x 2 ¹³ = 16,777,216 bits of information / motor revolution
M2	Optical encoder: Multiturn absolute EnDat 2.1			Absolute (more than 4,096 motor revolutions)	

Fig.7-1: Technical data of the motor encoder

Optical Encoder: Singleturn Option S1, S2

These encoders permit absolute, indirect position recording within **one** mechanical motor rotation. The encoders replace separate incremental encoders on the motor.



After a power failure or after the first POWER ON, the axis must always at first be moved to its home position.

Exception: Applications in which the maximum working path is within one mechanical rotation of the motor.

Optical Encoder: Multiturn Absolute Option M1, M2

These encoders permit absolute, indirect position recording within **4,096** mechanical motor rotations. The encoders replace a separate absolute value encoder on the motor. With this encoder version, the absolute position of the axis is preserved even after a switch-off.

7.2 Holding Brakes

In **normal operation**, use the brake only when at a standstill and when performing the drive-internal brake check. The holding brake serves to hold the axis, when the machine is in the de-energized state.

When using holding brakes, observe the additional information in [chapter 9.10 "Holding Brakes "](#) on page 242 .



For technical data and the availability of holding brakes, see chapters "Technical Data" and "Type Codes".

7.3 Fan Units for MSK Motors

7.3.1 Field of Application

MSK motors can be equipped with fan units. The fan units LEM are available as accessory. Special motors can be delivered with factory-mounted fan units. Fan units are intended for mounting on motors used in high repetition rates or continuous operation.



Motors with mounted fan units are not suited for applications with continuous shock load, e.g. pressing, squeezing, chargers, ...

In such cases, use motors with higher performance without fan unit or liquid cooled motors.

The following frame sizes are available.

Axial

For applications that make a slight frame size necessary.

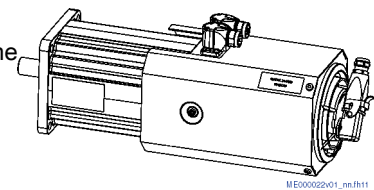

Radial

For applications that make a short frame size necessary.

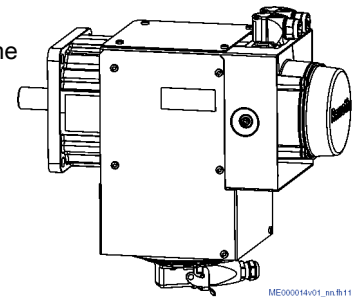

Accessories and Options

7.3.2 Technical Data

Type	Degree of protection ¹⁾	UL	U _N [V]	f _N [Hz]	I _N [A]	L _p [dB(A)]	m _i [kg]
LEM-AB-116T-11-NNNN	IP 65	self protected	115 ±10%	60	0.42	<75	2.3
LEM-RB-116T-11-NNNN							3.0
LEM-AB-116T-21-NNNN	IP 65	self protected	230 ±10%	50/60	0.19 / 0.17	<75	2.3
LEM-RB-116T-21-NNNN							3.0
LEM-AB-140T-11-NNNN	IP 65	self protected	115 ±10%	60	0.44	<75	3.1
LEM-RB-140T-11-NNNN							3.5
LEM-AB-140T-21-NNNN	IP 65	self protected	230 ±10%	50/60	0.20 / 0.18	<75	3.1
LEM-RB-140T-21-NNNN							3.5
LEM-AB-192T-11-NNNN	IP 65	self protected	115 ±10%	60	0.48	<75	4.3
LEM-RB-192T-11-NNNN							3.6
LEM-AB-192T-21-NNNN	IP 65	self protected	230 ±10%	50/60	0.21 / 0.20	<75	4.3
LEM-RB-192T-21-NNNN							3.6
LEM-AB-260N-32-NNNN	IP 65	-	400 ... 480	50/60	0.12 / 0.15 ²⁾	<75	8.6

1) Blower motor

2) Power consumption at 400V

Fig. 7-2: Technical data of fan units

For further information regarding protection class see [chapter 9.2 "Degree of Protection"](#) on page 229.

7.3.3 Select the Fan Unit

ZN-40004-001_NOR_N_EN_2008-09-12.fh11

Abbrev. Column	1	2	3	4	5	6	7	8	9	0	1	2	3	4	5	6	7	8	9	0	2	1	2	3	4	5	6	7	8	9	0	3	1	2	3	4	5	6	7	8	9	0	4			
Example:	L	E	M	-	A	B	-	1	9	2	N	-	2	1	-	N	N	N	N																											

Type
LEM = LEM

Cooling mode
Axial = A
Radial = R

Cooling direction
Blowing = B

Dimension of flange ①
116 mm = 116
140 mm = 140
192 mm = 192
260 mm = 260

Construction
Standard = N
Thermal protection = T

Nominal voltage
1 x AC 115 V, 60 Hz = 1
1 x AC 230 V, 50/60 Hz = 2
3 x AC 400...480 V, 50/60 Hz = 3

Electrical connection
Connector 1 x AC = 1
Connector 3 x AC = 2

Other design
None = NNNN

Note:
① Dimension of flange "116", "140" and "192" are only available with construction "T", nominal voltage "1" and "2" and electrical connection "1"
Dimension of flange "260" ist only available mit cooling mode "A", construction "N", nominal voltage "3" and electrical connection "2"

Fig.7-3: Type code of fan units LEM for MSK motors

Select the fan unit for the motor type required from the following table

Motor	Brake	LEM-AB-116T	LEM-RB-116T
MSK060C	0	■	□
MSK060C	1	■	■
MSK061C	0, 1	■	■

Motor	Brake	LEM-AB-140T	LEM-RB-140T
MSK070C	0, 1	■	-
MSK070D	0, 1	■	□

Accessories and Options

Motor	Brake	LEM-AB-140T	LEM-RB-140T
MSK070E	0, 1	■	■
MSK071C	0	■	□
MSK071C	1,2	■	■
MSK071D	0, 1, 2	■	■
MSK071E	0, 1, 2	■	■
MSK075C	0, 1, 2	■	■
MSK075D	0, 1, 2	■	■
MSK075E	0, 1, 2	■	■
MSK076C	0, 1	■	□

Motor	Brake	LEM-AB-192T	LEM-RB-192T
MSK100A	0, 1	■	-
MSK100B	0, 1, 2	■	■
MSK100C	0, 2	■	■
MSK100D	0, 2	■	■
MSK101C	0, 2	■	□
MSK101D	0, 2, 3	■	■
MSK101E	0, 2, 3	■	■

Motor	Brake	LEM-AB-260N	-
MSK131B	0, 1	■	-
MSK131D	0, 1, 2	■	-

- not deliverable, assembly not possible
- ex works mounted deliverable
- deliverable as adapter kit.

Fig.7-4: Selection matrix motor-fan unit



Mounting order for as "adapter kit □" delivered fan units:

1. Flange on the motor without fan unit onto the machine
2. Mount the fan unit

7.3.4 Electrical Connection

Connection 1-phase

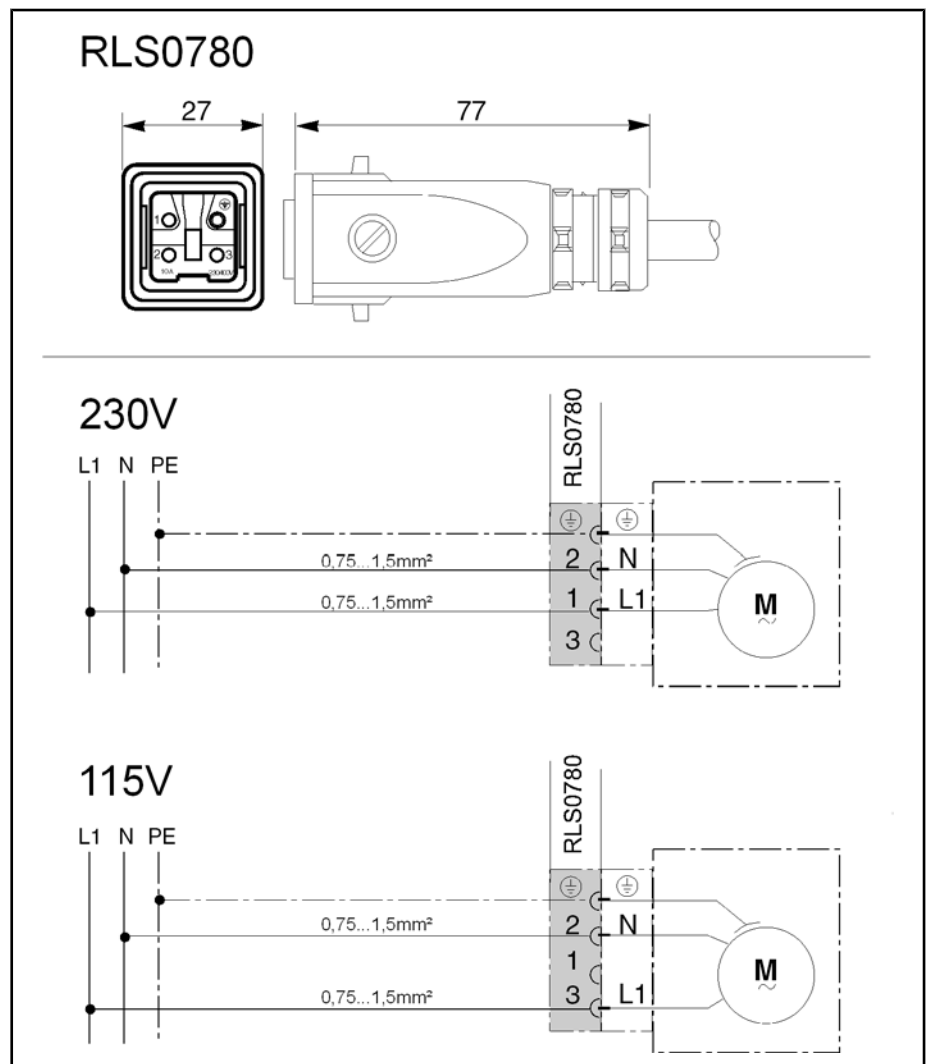

RLS0780 Clamping area cable gland 7 ... 10 mm

Fig.7-5: Fan connection 1-phase with protection switch

LEM fan units in design "T" with integrated thermo protection do not need any circuit with external motor protection switch.



Protection from false connection!

- 230V: L1 auf Pin 1
- 115V: L1 auf Pin 3

Accessories and Options

Connection 3-phase

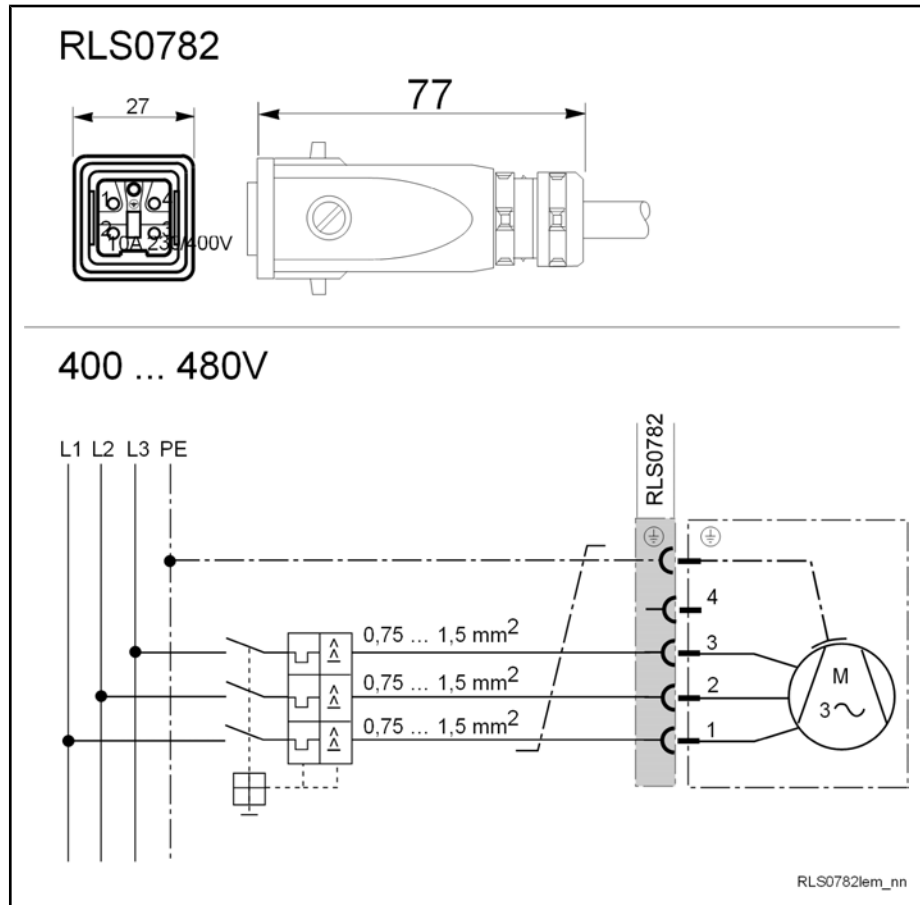

RLS0782 Clamping area cable gland 7 ... 10 mm
 Fig. 7-6: Fan connection 3-phase with protection switch

Protection due to motor protection switch

The activation of the fan units is done via the adjustable motor protection device. The activate principle of the motor protection switch is based on the fact that the motor current-carrying bimetal trip heats up faster than the motor winding and it separates this from the mains before critical temperature values are reached.

The motor protection switches are adjusted to the rated current of the fan unit. Heed when selecting the motor protection switch that the adjustable range must agree with the rated current of the fan unit.

7.3.5 Order

Motor with attached fan unit In order to procure a motor with attached fan unit, the type designation of the fan unit must be specified as an ordering subitem of the motor with the fan arrangement desired.

Ordering item	Ordering designation
1	Synchronous motor MSK100B-0300-NN-S1-BG1-NNNN
1.1	Fan unit LEM-AB-192T-11-NNNN mounted on position 1

Motor with separate fan unit If it is specified as an independent ordering item, the fan unit is supplied separately from the motor (i.e. not attached to the latter).

Ordering item	Ordering designation
1	Synchronous motor MSK100B-0300-NN-S1-BG1-NNNN
2	Fan unit LEM-AB-192T-11-NNNN

Accessories and Options

7.3.6 Specifications
MSK060 Fan Unit Axial

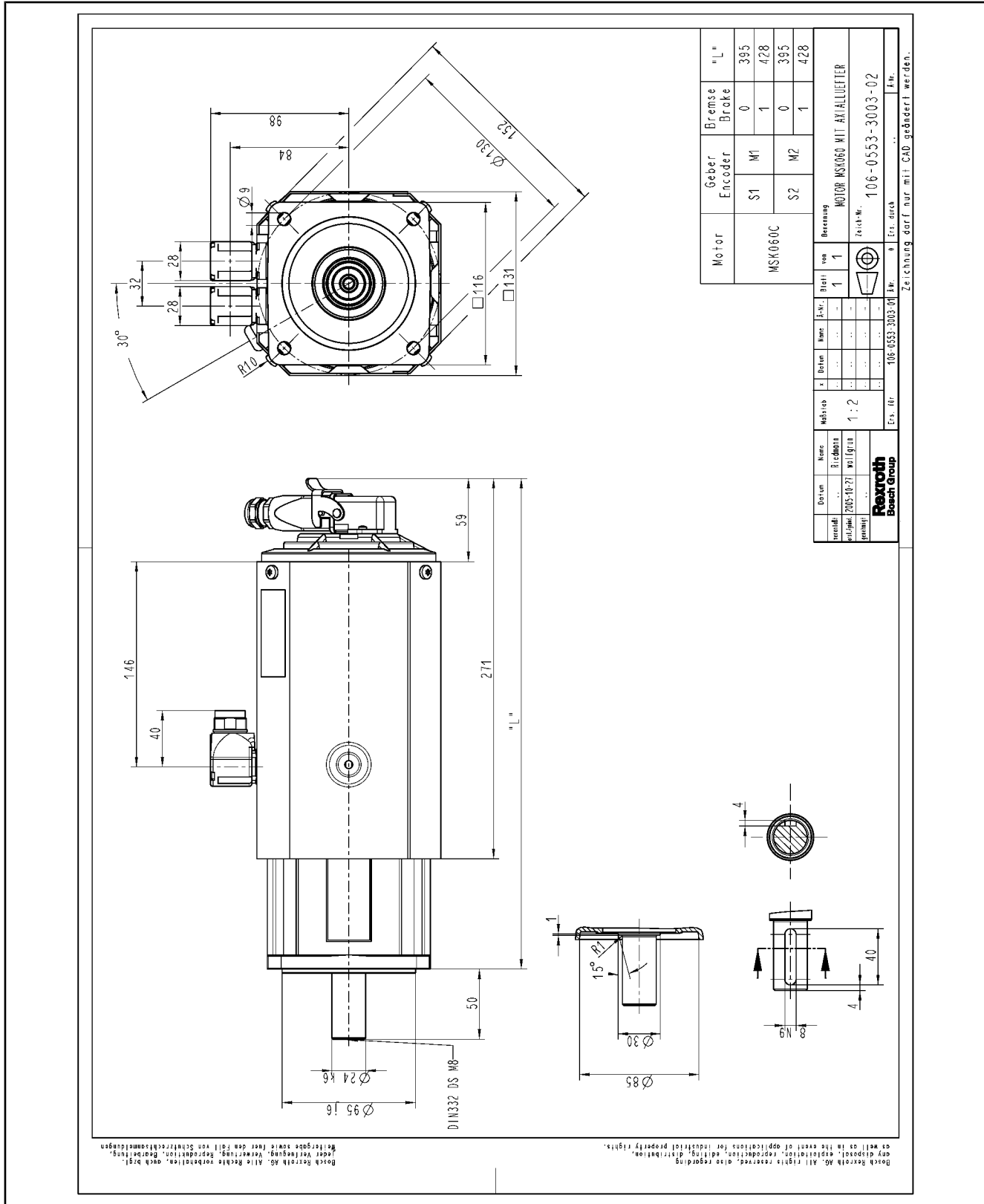

Fig.7-7: Dimension sheet MSK060 with axial fan unit

MSK060 Fan Unit Radial

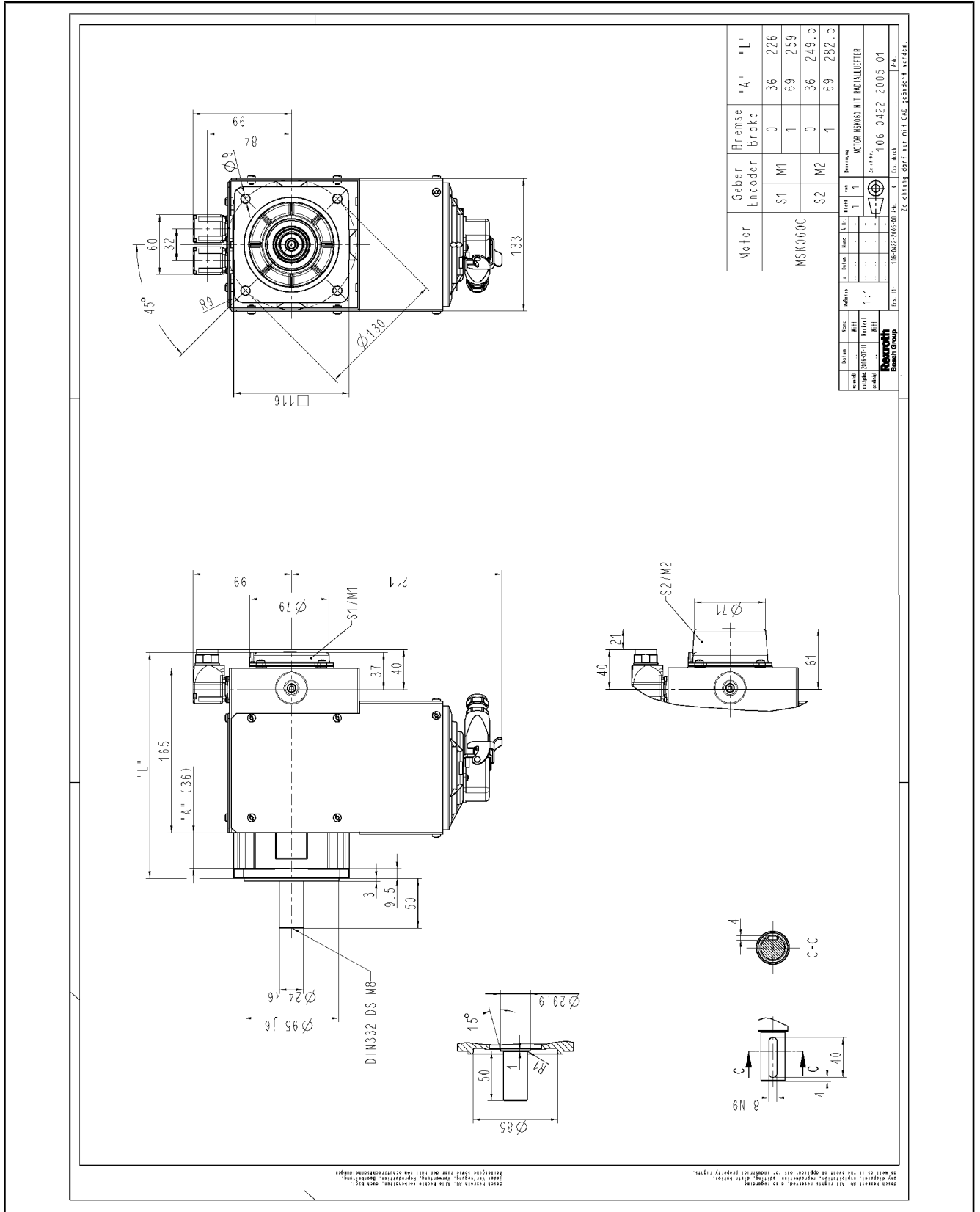

Fig.7-8: Dimension sheet MSK060 with radial fan unit

Accessories and Options

MSK061 Fan Unit Axial

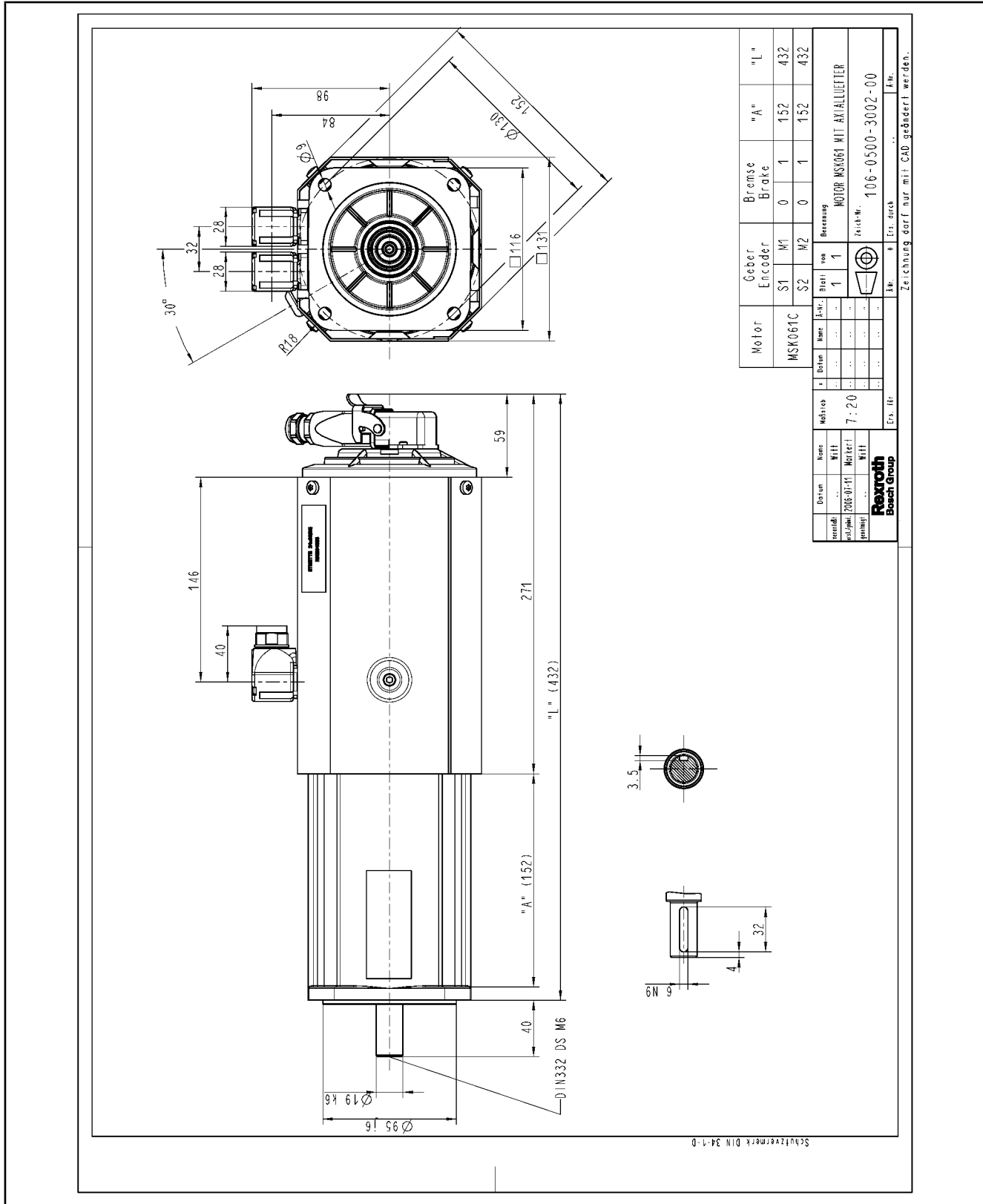

Fig.7-9: Dimension sheet MSK061 with axial fan unit

MSK061 Fan Unit Radial

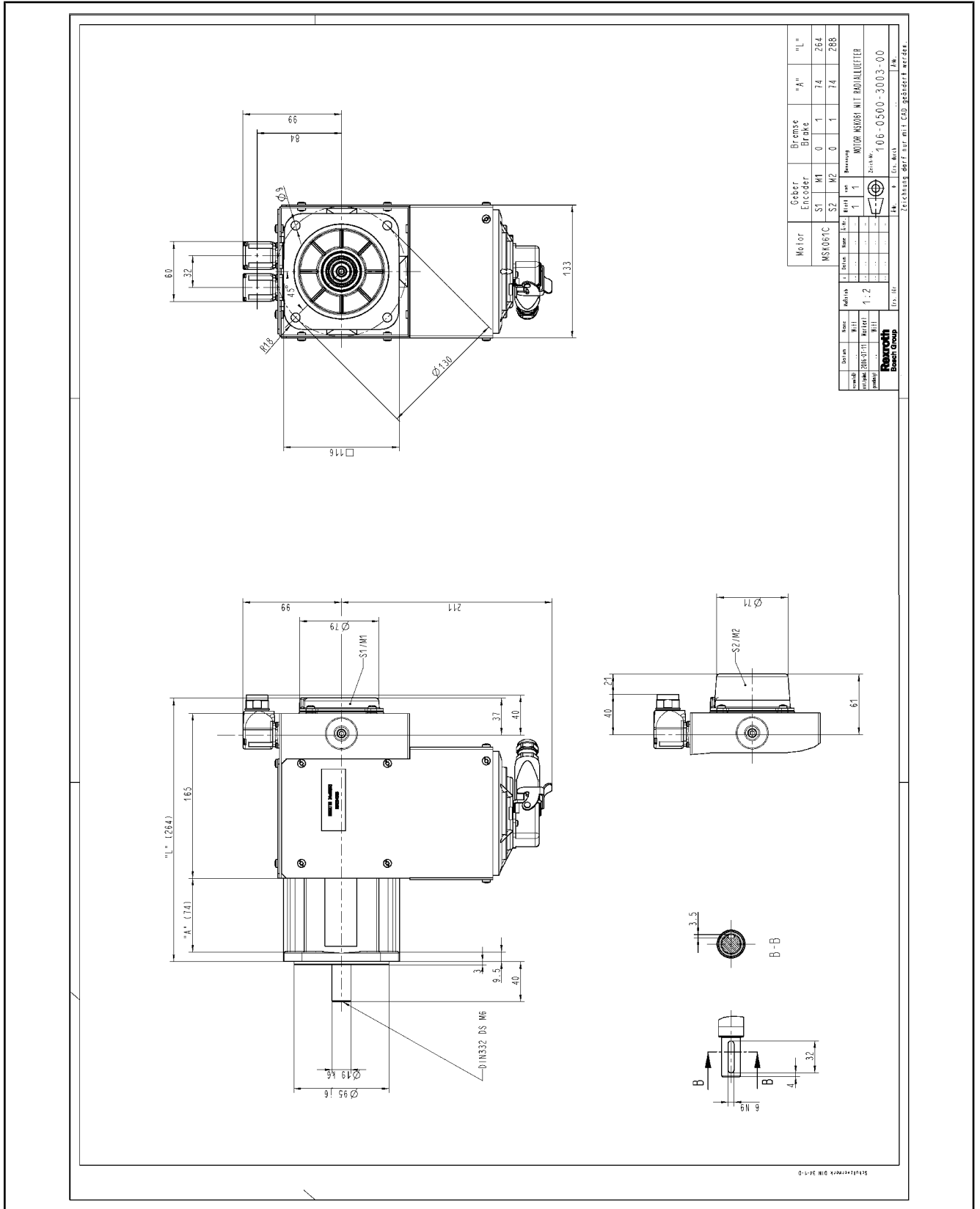

Fig.7-10: Dimension sheet MSK061 with radial fan unit

Accessories and Options

MSK070 Fan Unit Axial

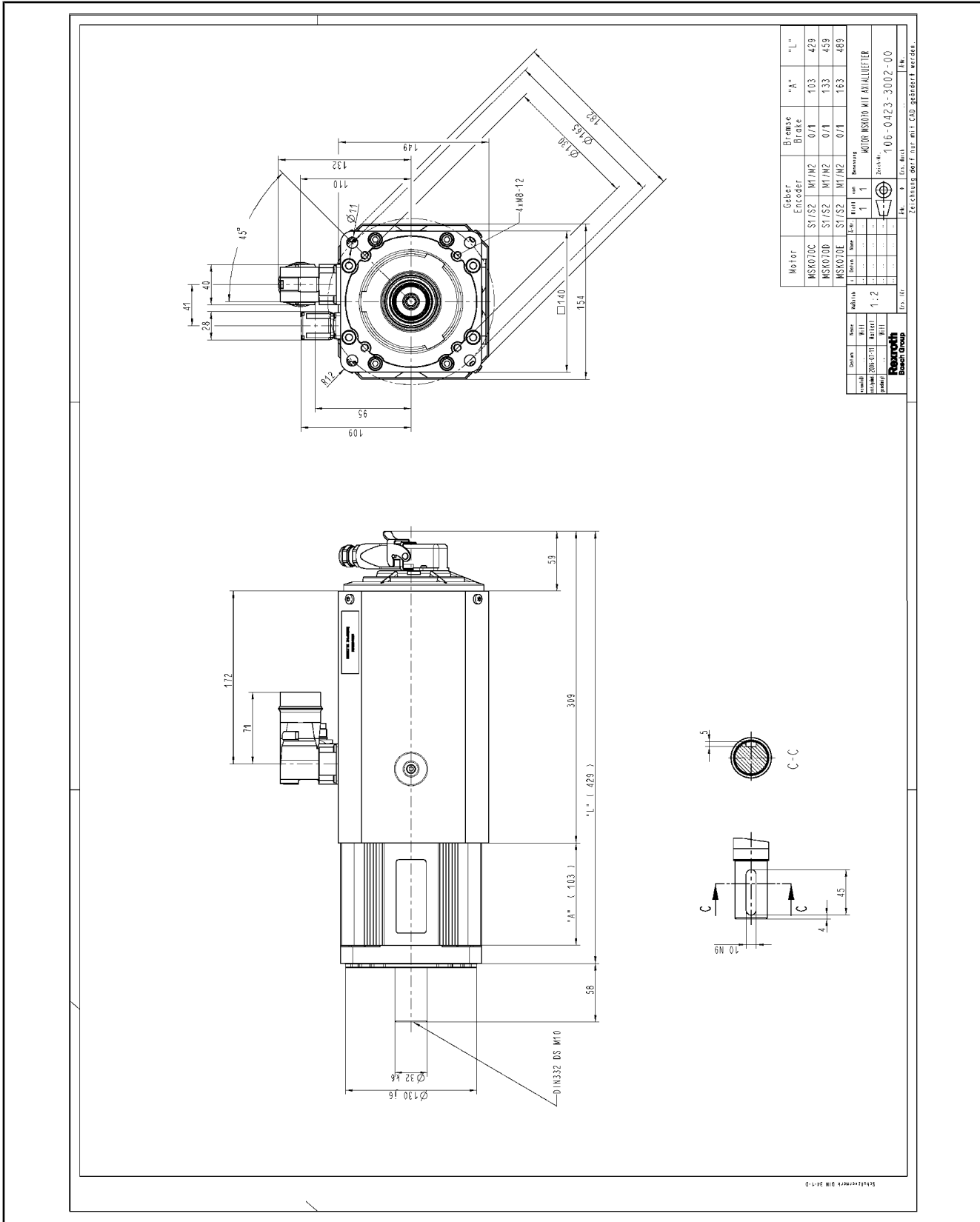

Fig.7-11: Dimension sheet MSK070 with axial fan unit

MSK070 Fan Unit Radial

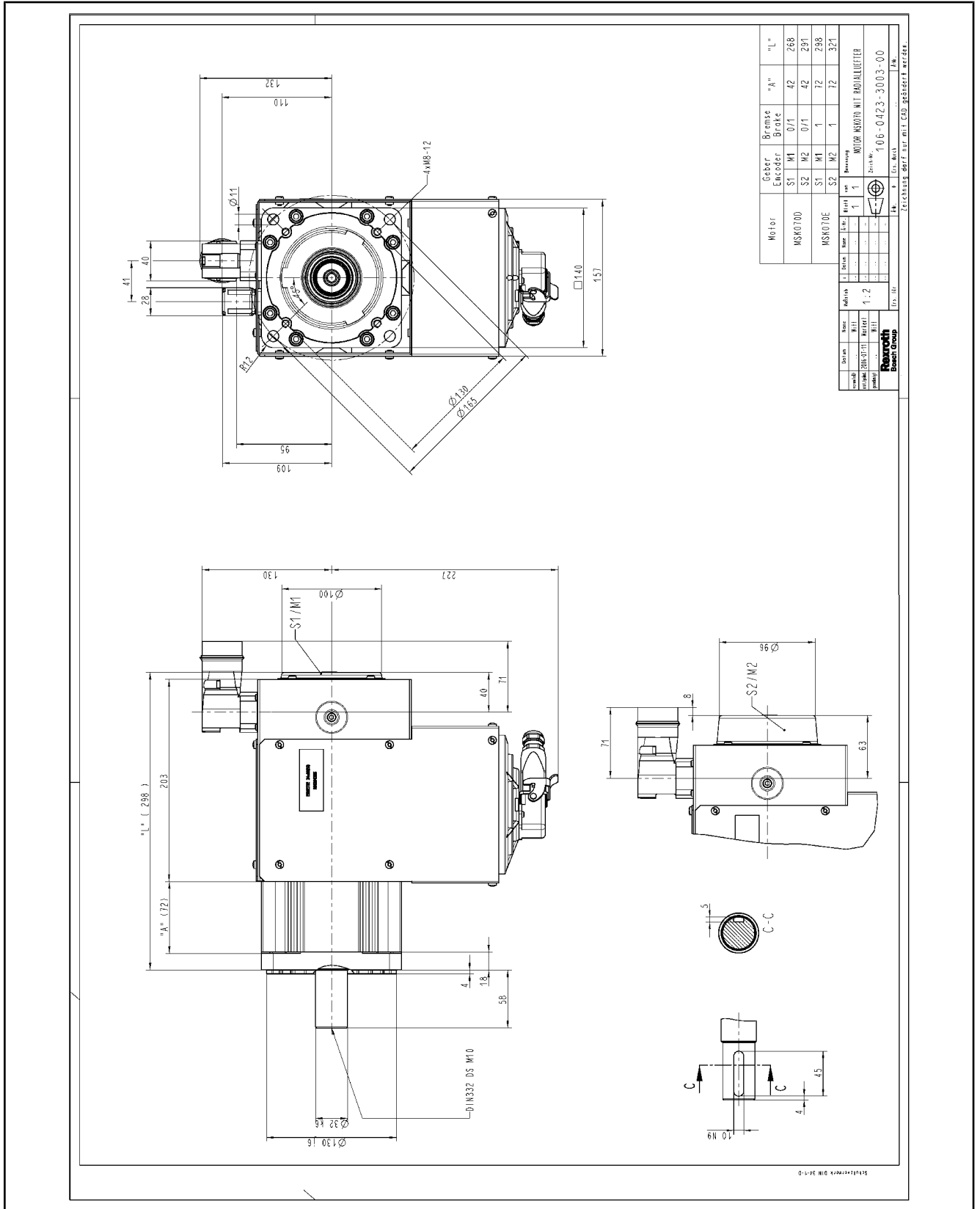

Fig.7-12: Dimension sheet MSK070 with radial fan unit

Accessories and Options

MSK071 Fan Unit Axial

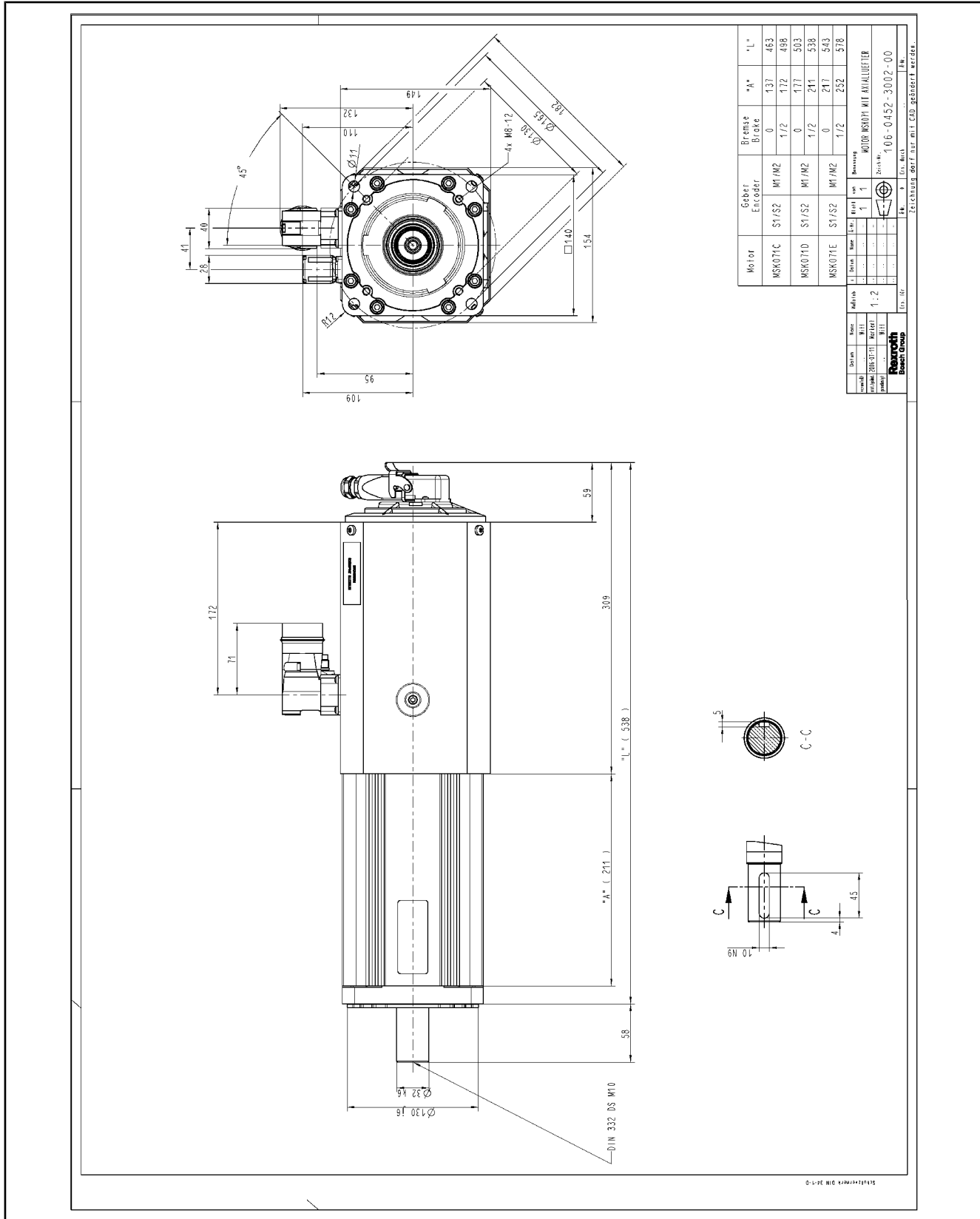

Fig.7-13: Dimension sheet MSK071 with axial fan unit

MSK071 Fan Unit Radial

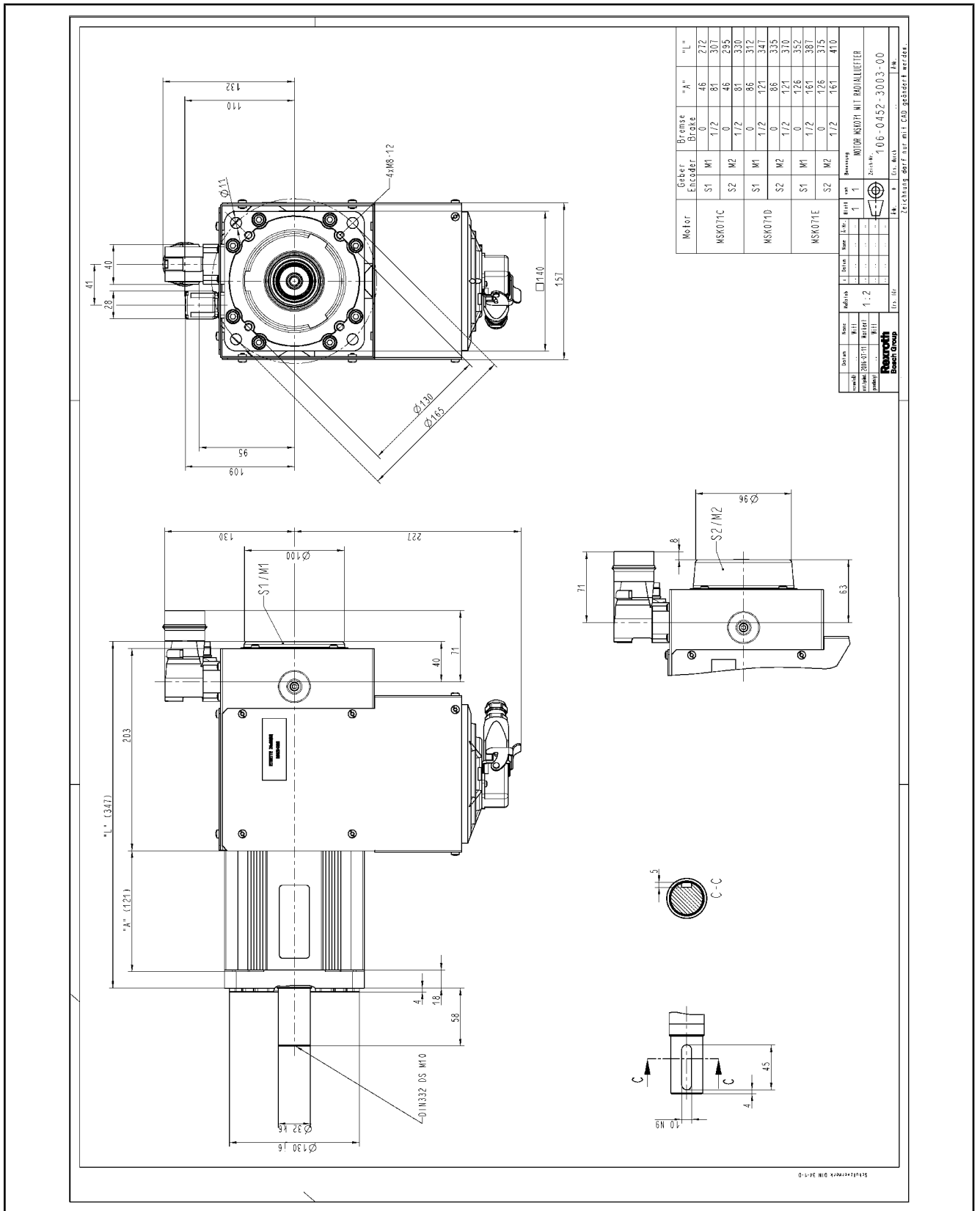

Fig.7-14: Dimension sheet MSK071 with radial fan unit

Accessories and Options

MSK075 Fan Unit Axial

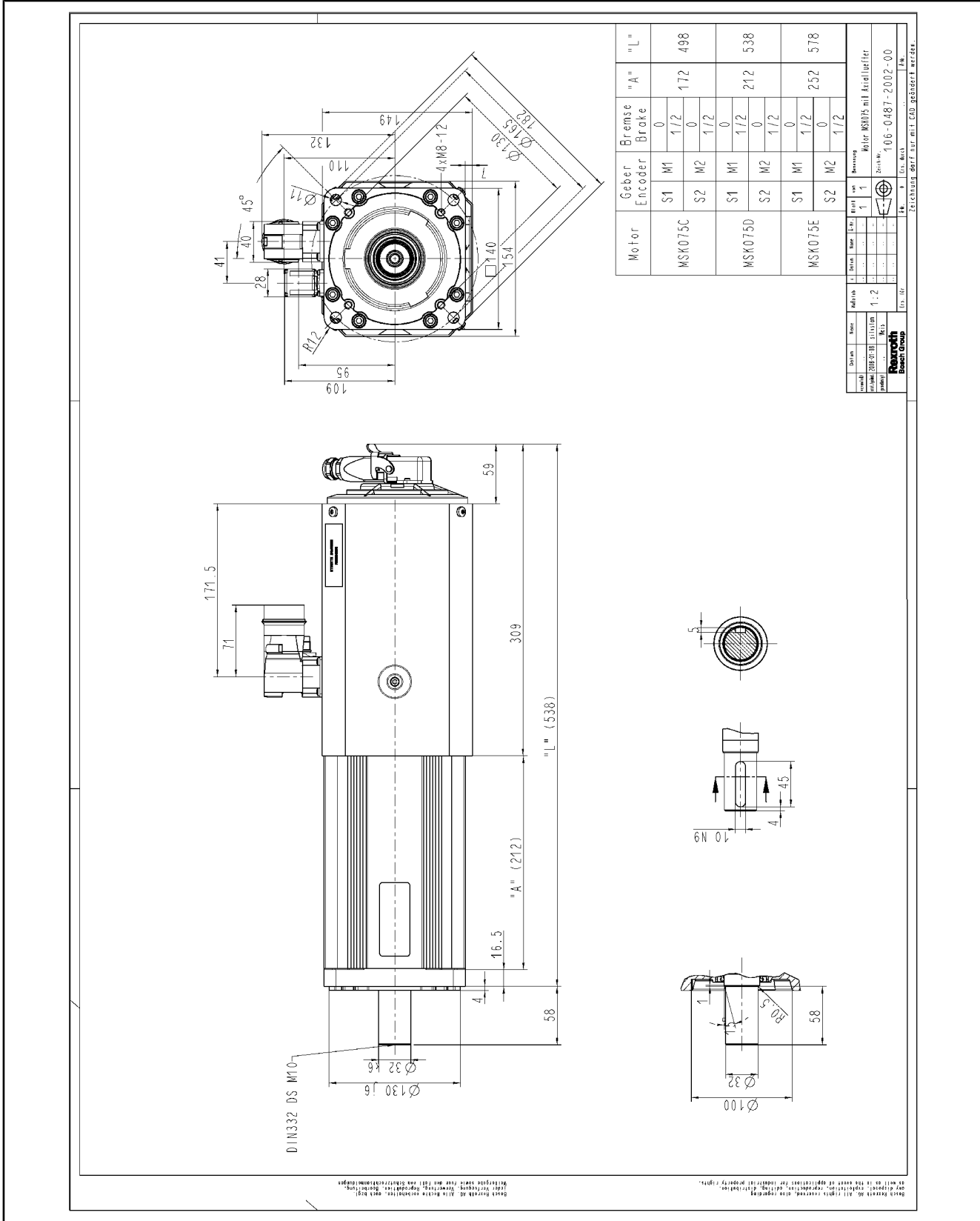

Fig.7-15: Dimension sheet MSK075 with axial fan unit

MSK075 Fan Unit Radial

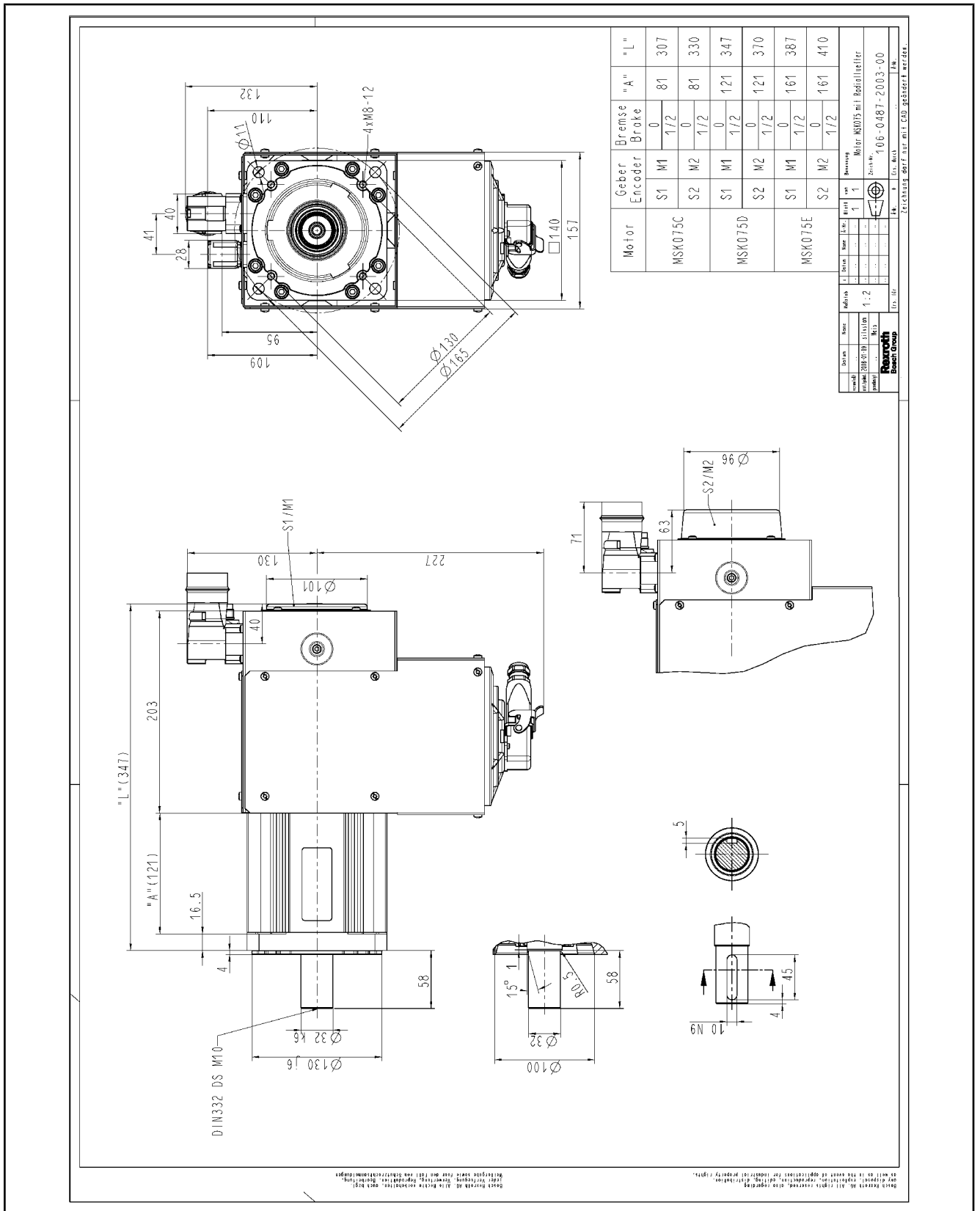

Fig.7-16: Dimension sheet MSK075 with radial fan unit

Accessories and Options

MSK076 Fan Unit Axial

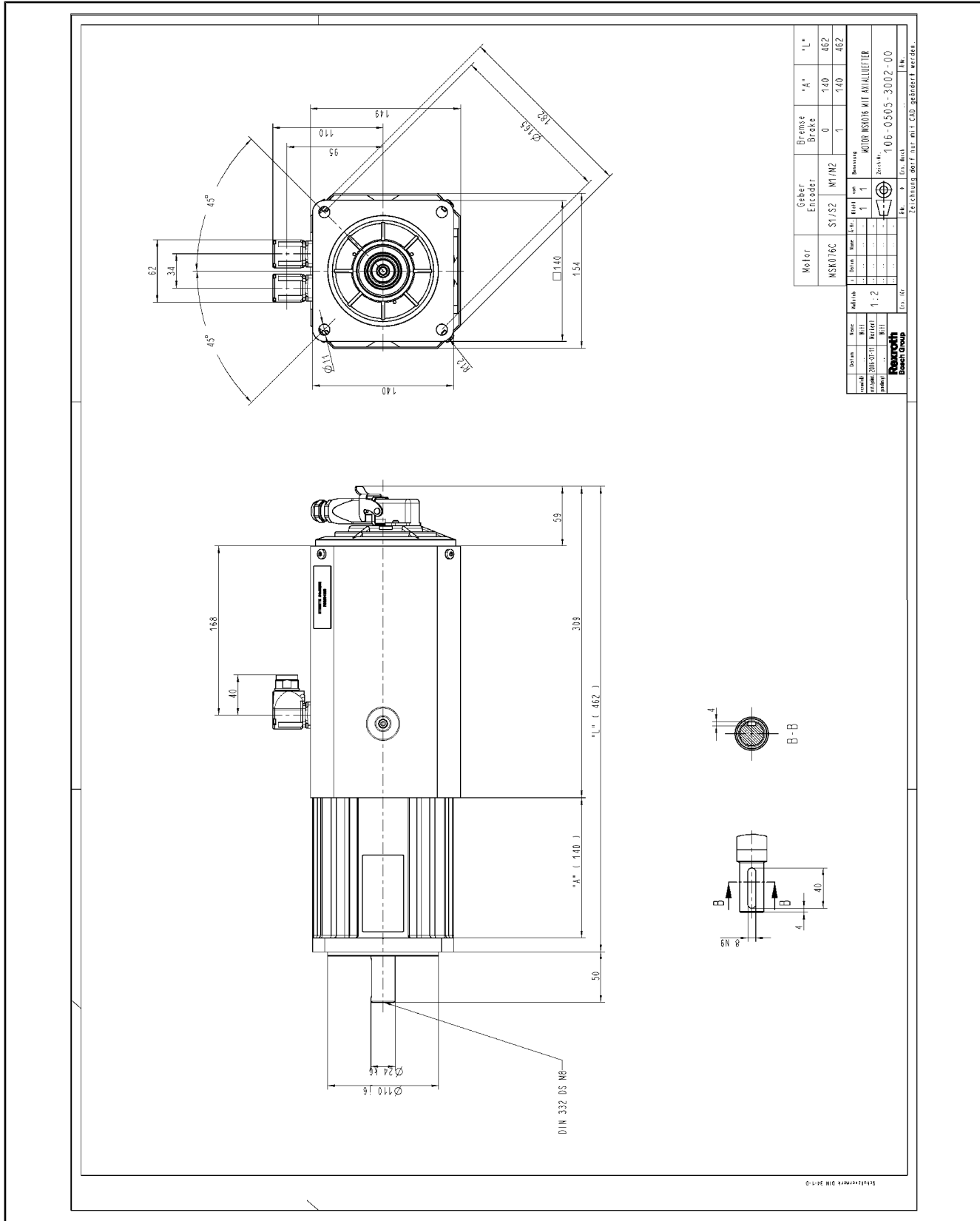

Fig.7-17: Dimension sheet MSK076 with axial fan unit

MSK076 Fan Unit Radial

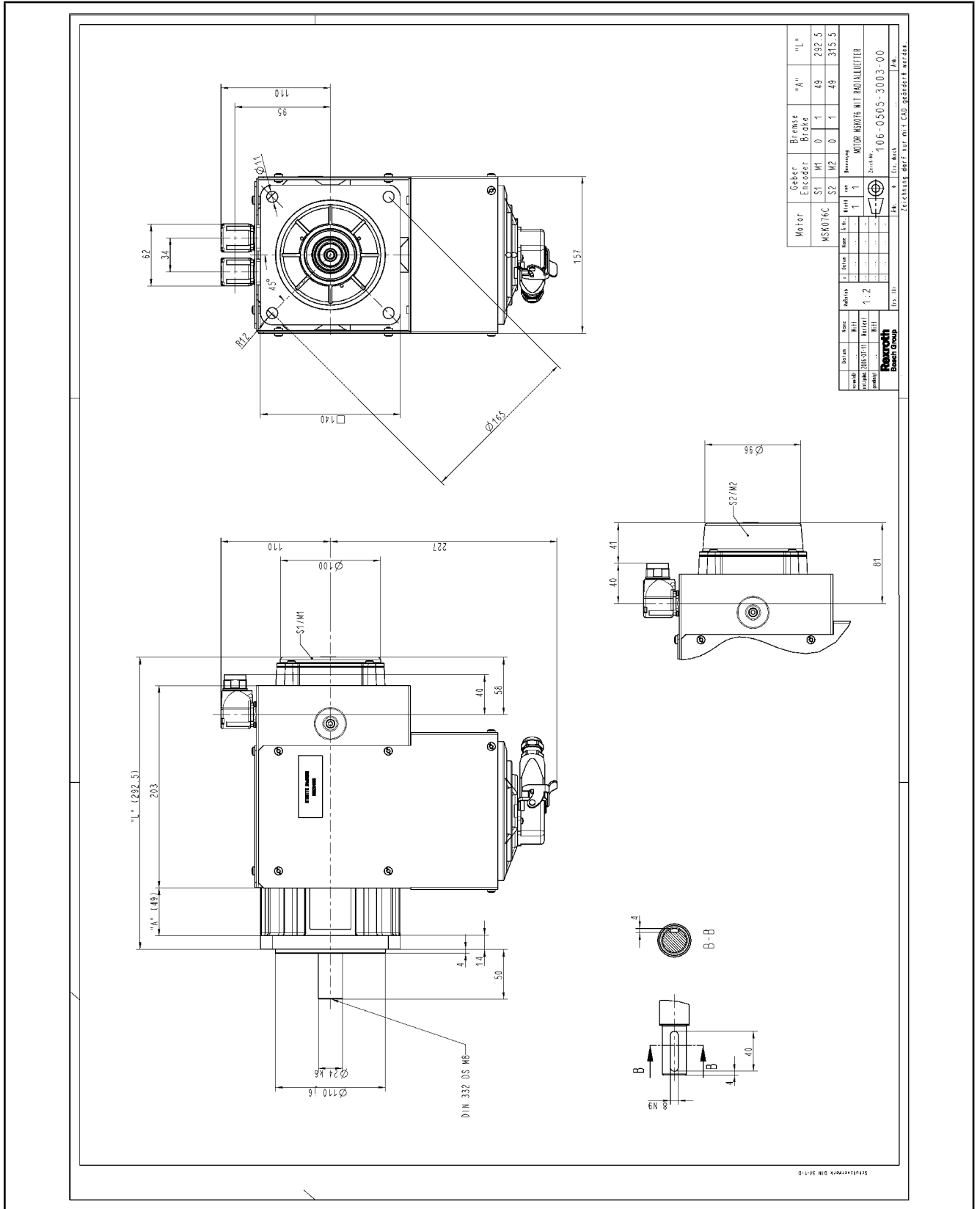
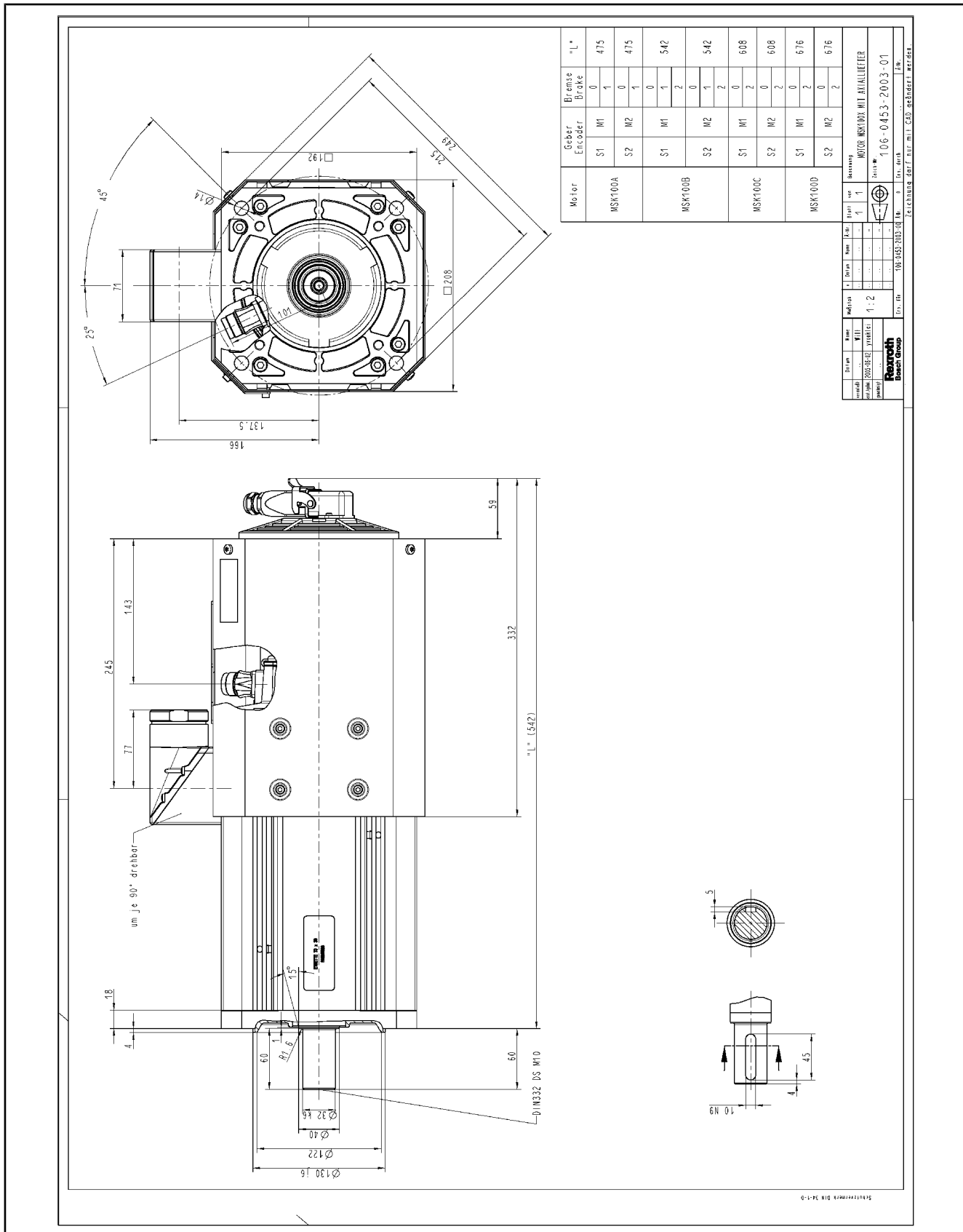

Fig.7-18: Dimension sheet MSK076 with radial fan unit

Accessories and Options

MSK100 Fan Unit Axial



Motor	Gebae Encoder	Bremse Brake	"L"
MSK100A	S1	0	475
	S2	1	475
MSK100B	S1	0	542
	S2	1	542
MSK100C	S1	0	608
	S2	1	608
MSK100D	S1	0	676
	S2	1	676

Motor	Gebae Encoder	Bremse Brake	"L"
MSK100E MSK100F MIT AXIALFUEHNER			
106-0453-2003-01			

Fig.7-19: Dimension sheet MSK100 with axial fan unit

MSK100 Fan Unit Radial

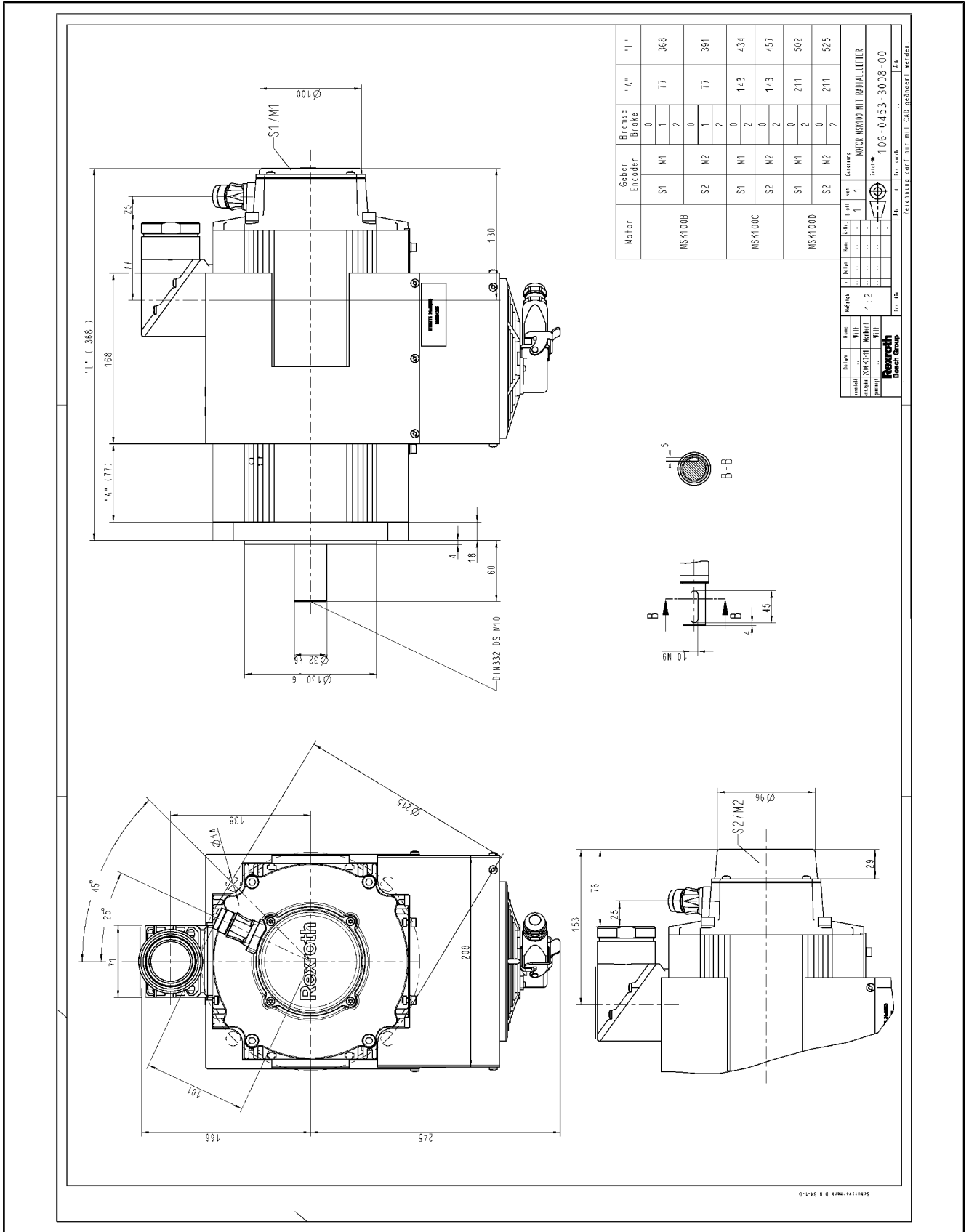

Fig.7-20: Dimension sheet MSK100 with radial fan unit

Accessories and Options

MSK101 Fan Unit Axial

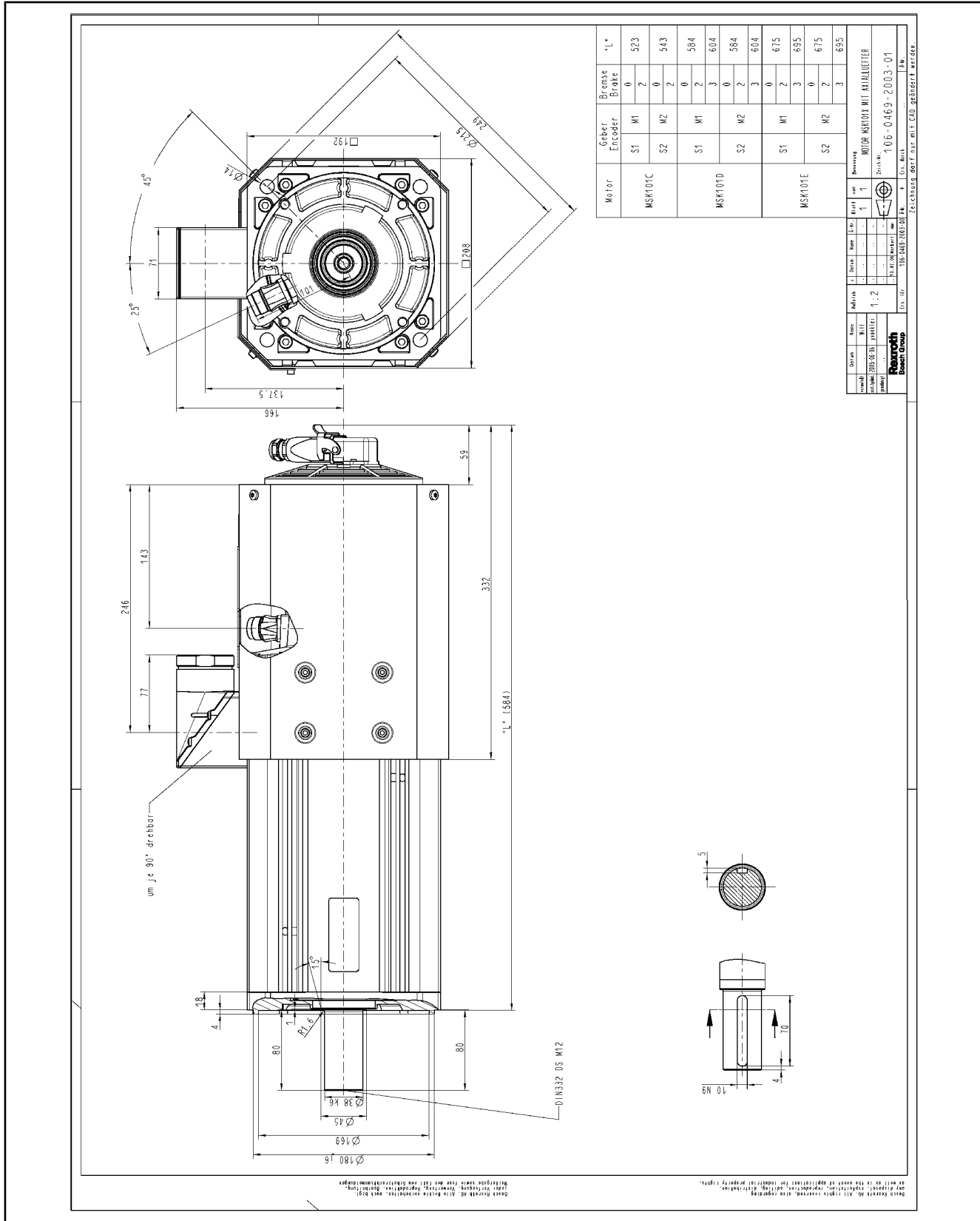

Fig.7-21: Dimension sheet MSK101 with axial fan unit

MSK101 Fan Unit Radial

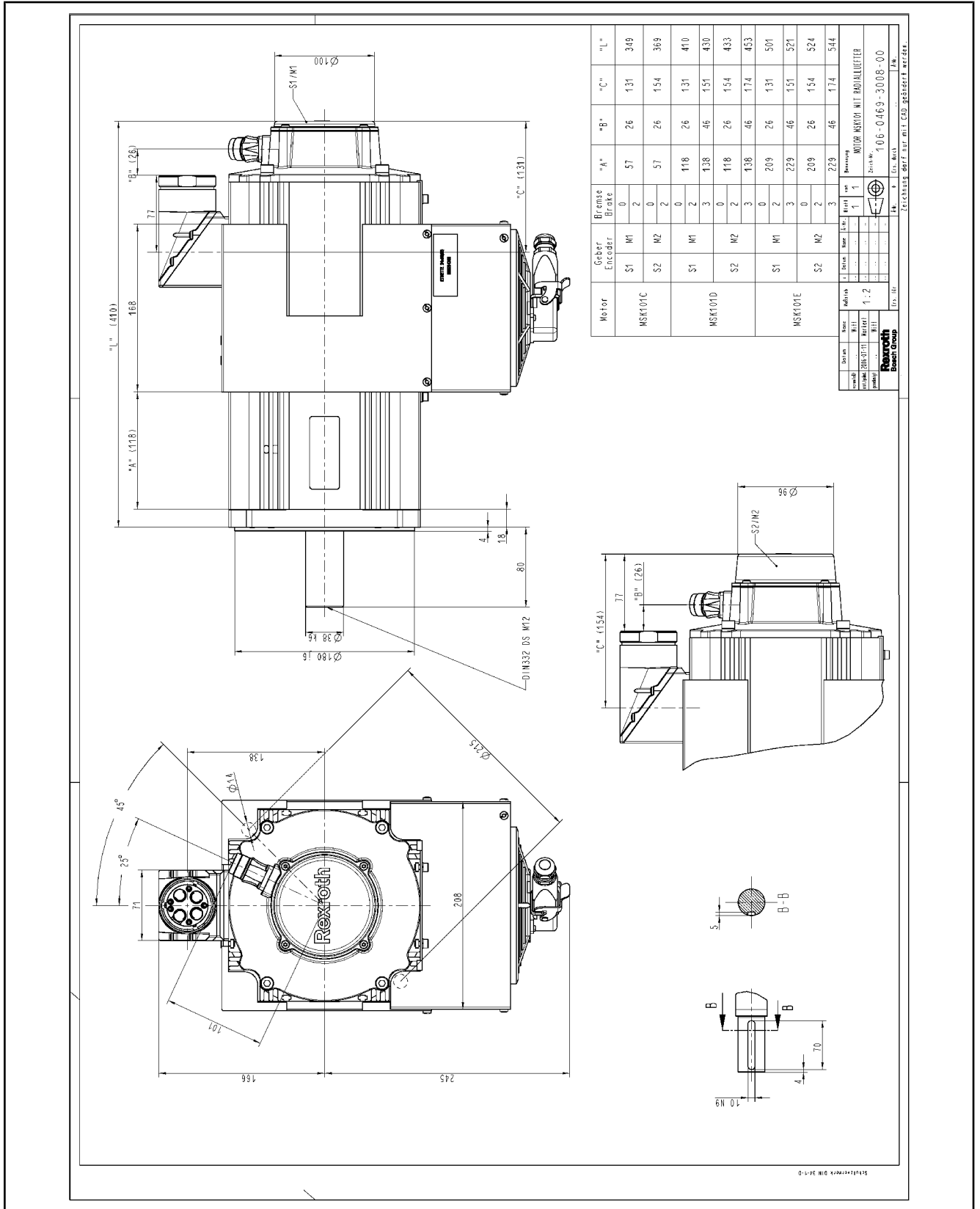

Fig.7-22: Dimension sheet MSK101 with radial fan unit

Accessories and Options

MSK131 Fan Unit Axial

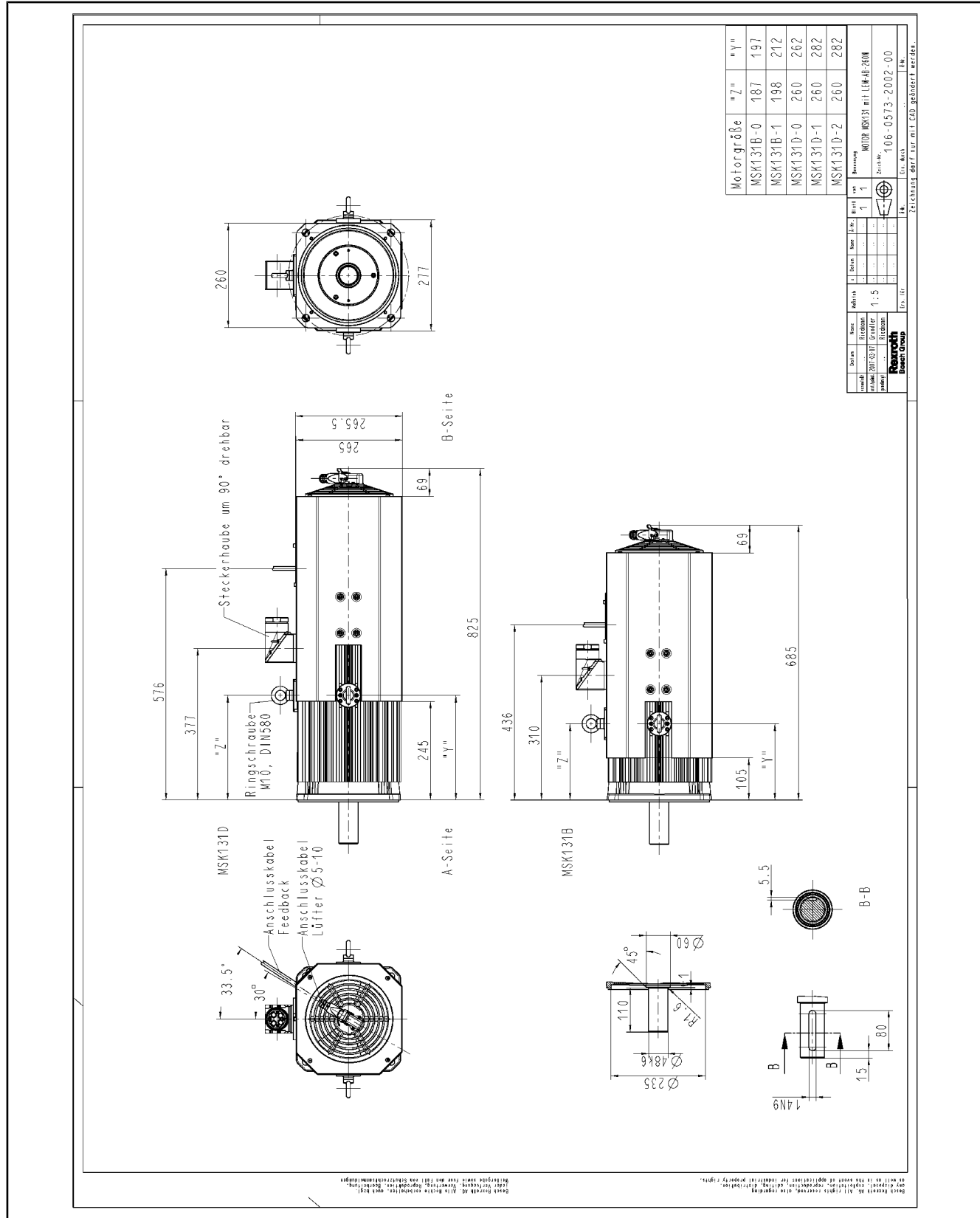

Fig.7-23: Dimension sheet MSK131 with axial fan unit

Accessories and Options

7.3.7 Assembly

Assembly Fan Unit Axial, Flange dimension 116/140

Valid for types:	LEM-AB116N-xx-NNNN LEM-AB116T-xx-NNNN LEM-AB140A-xx-NNNN LEM-AB140T-xx-NNNN
------------------	--

Part	Designation	Type	L/B/H [mm]	Screw type	M _{GAL} [Nm]	Number
K	Ridge	LEM-AB116N / ...T	25/8/3	-	-	3
K	Ridge	LEM-AB140A / ...T	25/10/4	-	-	3
A	Fastening screw	LEM-AB116N / ...T	-	M5 x 8	4.0	3
A	Fastening screw	LEM-AB140A / ...T	-	M5 x 8	6.0	3

Fig.7-24: Assembly Fan Unit Axial, Flange dimension 116/140

Mounting instructions:

1. Insert the ridges Kas far as it will go into the groovings on the end shield.
2. Insert the fan unit onto the end shield.
3. Tighten the fastening screws A. For tightening torque see table.



At assembly, the mounting screws must be locked against self-detaching due to crushes and vibrations. The medium screw safety **Loctite® 243™** is recommended by Bosch Rexroth.

For re-assembly, secure the screws again!

Heed the details of the manufacturer according to the data sheet.

4. Electrical connection according to the connection plan.

Accessories and Options

Assembly Fan Unit Axial, Flange Dimension 192

Valid for types:	LEM-AB-192N-xx-NNNN LEM-AB-192T-xx-NNNN
------------------	--

ME000026v01_nn.fh11

Part	Designation	Type	L/B/H [mm]	Screw type	M _{GA} [Nm]	Number
M	Ridge	LEM-AB192N / ...T	113/8/3	-	-	4
A	Fastening screw	LEM-AB192N / ...T	-	M5 x 8	4,0	8
C	Cover of encoder cable output	LEM-AB192N / ...T	-	M4 x 8	3,1	3

Fig.7-25: Assembly Fan Unit Axial, Flange Dimension 192

Mounting instructions:

1. Insert the ridges M into the groovings on the housing.
2. Insert the fan unit as far as it will go onto the housing.
3. Tighten the fastening screws A. For tightening torque see table.



At assembly, the mounting screws must be locked against self-detaching due to crushes and vibrations. The medium screw safety **Loctite® 243™** is recommended by Bosch Rexroth.

For re-assembly, secure the screws again!

Heed the details of the manufacturer according to the data sheet.

4. If necessary loosen the cover of the encoder cable output, connect the encoder cable and mount the cover. Refer to the table for tightening torque of the fastening screws for the cover encoder cable output.
5. Electrical connection according to the connection plan.

Accessories and Options

Assembly Fan Unit Axial, Flange Dimension 116/140

Valid for types:	LEM-RB-116N-xx-NNNN LEM-RB-116T-xx-NNNN LEM-RB-140A-xx-NNNN LEM-RB-140T-xx-NNNN
------------------	--

Part	Designation	Type	L/B/H [mm]	Screw type	M _{GA} [Nm]	Number
K	Ridge	LEM-AB116N / ...T	25/8/3	-	-	3
K	Ridge	LEM-AB140A / ...T	25/10/4	-	-	3
A	Fastening screw	LEM-AB116N / ...T	-	M5 x 8	4,0	3
A	Fastening screw	LEM-AB140A / ...T	-	M5 x 8	6,0	3
C	Fastening screw	LEM-AB116N / ...T	-	M4 x 6	3,1	4
C	Fastening screw	LEM-AB140A / ...T	-	M4 x 6	3,1	4

Fig.7-26: Assembly Fan Unit Radial, Flange Dimension 116/140

Mounting instructions:

1. Insert the ridges Kas far as it will go into the groovings on the end shield.
2. Insert the fan unit onto the end shield.
3. Tighten the fastening screws A. For tightening torque see table.



At assembly, the mounting screws must be locked against self-detaching due to crushes and vibrations. The medium screw safety **Loctite® 243™** is recommended by Bosch Rexroth.

For re-assembly, secure the screws again!

Heed the details of the manufacturer according to the data sheet.

4. Mount the cover plate with fastening screws C. For tightening torque see table.
5. Electrical connection according to the connection plan.

Accessories and Options

Assembly Fan Unit Radial, Flange Dimension 192

Valid for types:	LEM-RB-192N-xx-NNNN LEM-RB-192T-xx-NNNN	
------------------	--	--

ME000015v01_nn.fh11

Part	Designation	Type	L/B/H [mm]	Screw type	M _{GA} [Nm]	Number
N1	Ridge	LEM-RB192N / ...T	73/8/3	-	-	1
N2	Ridge	LEM-RB192N / ...T	223/8/3	-	-	2
B	Fastening screw	LEM-RB192N / ...T	-	M5 x 10	4,0	6
D	Fastening screw	LEM-RB192N / ...T	-	M4 x 8	3,1	6

Fig.7-27: Assembly Fan Unit Radial, Flange Dimension 192

Mounting instructions:

1. Insert the ridges N2 into the groovings onto the housing (see item X).

2. Fasten the fan top with the fastening screws B (4 pieces) into the ridges N2 on the motor housing. Use the limit stop P for positioning. For tightening torque see table.



At assembly, the mounting screws must be locked against self-detaching due to crushes and vibrations. The medium screw safety **Loctite® 243™** is recommended by Bosch Rexroth.

For re-assembly, secure the screws again!

Heed the details of the manufacturer according to the data sheet.

3. Mount the cover with the fastening screws D on the fan top. For tightening torque see table.
4. Insert the ridges N1 into the groovings onto the housing (see item Y).
5. Screw the cover with fastening screws B (2 pieces) into the ridge N1. For tightening torque see table.
6. Electrical connection according to the connection plan.

Accessories and Options

Assembly Fan Unit Axial, Flange Dimension 260

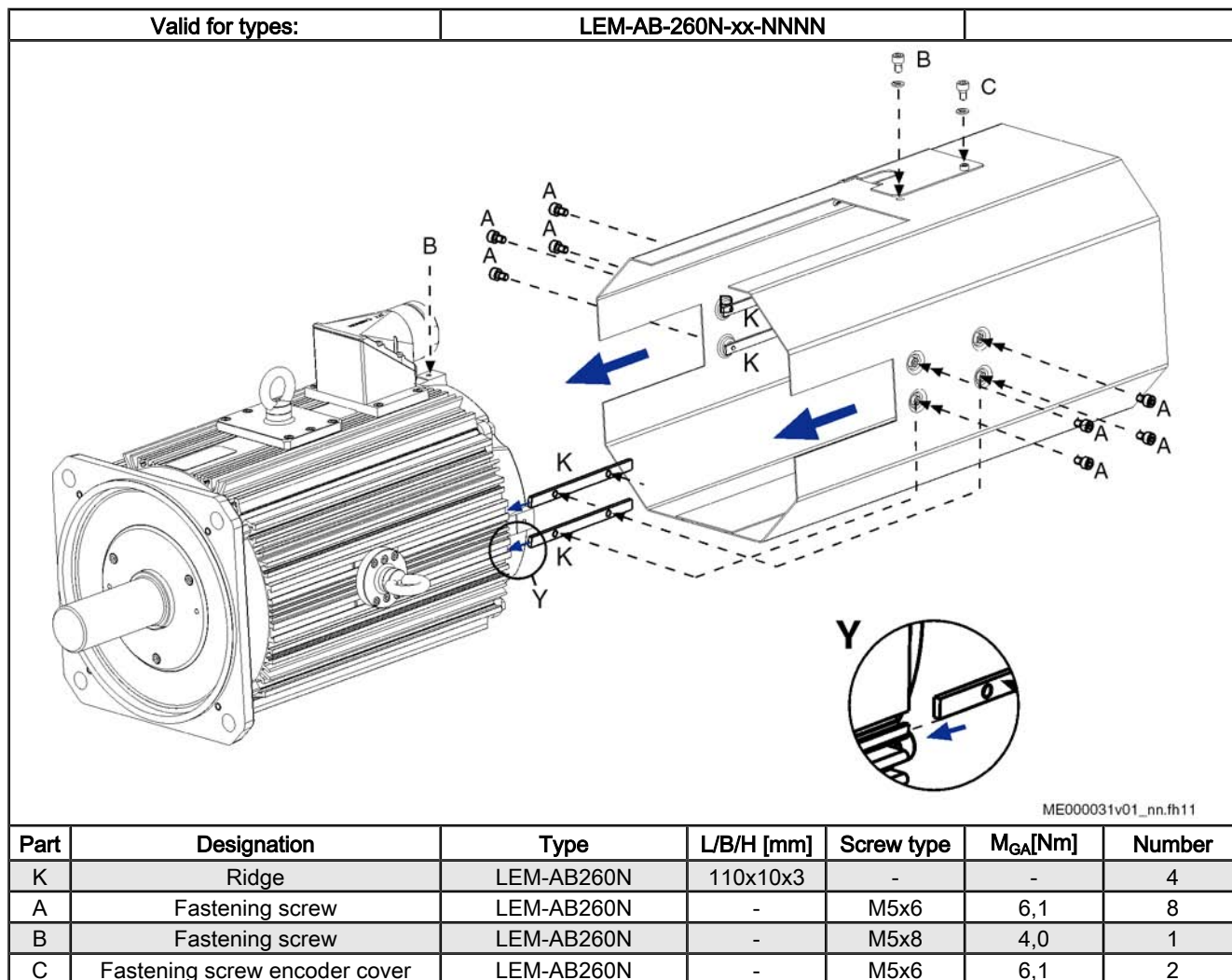

Fig.7-28: Assembly Fan Unit Axial, Flange Dimension 260

Mounting instructions:

1. Insert the ridges K into the groovings onto the housing (see item Y).
2. Fasten the fan top with the fastening screws A (8 pieces) into the ridges K on the motor housing. Use the fastening screws C for positioning. For tightening torque see table.



At assembly, the mounting screws must be locked against self-detaching due to crushes and vibrations. The medium screw safety **Loctite® 243™** is recommended by Bosch Rexroth.

For re-assembly, secure the screws again!

Heed the details of the manufacturer according to the data sheet.

3. If necessary loosen the cover of the encoder cable output, connect the encoder cable and mount the cover. Refer to the table for tightening torque of the fastening screws for the cover encoder cable output.
4. Electrical connection according to the connection plan.

7.4 Gearboxes

The gearboxes of the series

- GTM
- GTE

are optimally adjusted for the motors of the IndraDyn S series. The technical data, as well as the various transformation ratios, are described in a detailed document.

The product documentation of the gearboxes can be ordered at your responsible sales partner with the following ordering designations.

DOK-GEAR-GTE*****-PRxx-EN-P**

DOK-GEAR-GTM*****-PRxx-EN-P**

Heed when using gearboxes from other manufacturers:



CAUTION

Motor damage by intrusion of liquid!

Pending liquids (e.g. cooling lubricants, gearbox oil, etc.) at the drive shaft are inadmissible.

When installing gearboxes please use gearboxes with closed (oil-proof) lubrication system only. Gearbox oil should not be in permanent contact with the shaft sealing ring of the motors.

Accessories and Options

7.5 Sealing Air Connection

7.5.1 General Information

Function, description Air sealing connection kits make it possible to bring in a defined overpressure into the inner motor. This procedure reliably prevents damaging fluids from penetrating through sealing points that are at risk. The areas of application for sealing air are all installation locations in which humid air or coolant can come into direct contact with the motors, especially in wetrooms.

 Damage due to continuously existing liquid on the shaft sealing ring! The use of sealing air does **not** prevent the penetration of continuously existing liquid on the shaft sealing ring (e.g. for open gearboxes). Due to capillary effects gearbox-oil can penetrate into the motor and lead to damage despite using sealing air.

Conditions, Precondition In order to use sealing air in IndraDyn S motors, the system must have a compressed air connection. The required compressed air preparation system and the hoses for the compressed air must be provided by the customer.

 Notice the specified working pressure for the motors!

7.5.2 Technical Data

Designation	Symbol	Unit	Value
Working pressure	p	bar	0,1 ± 0,05
Max. relative air humidity	φ	%	20...30
Air			dust-free
			oil-free
necessary compressed air hose			4 × 0,75 (not included in scope of delivery)

Fig.7-29: Technical data for IndraDyn S air-pressure connector kit

7.5.3 Ordering Designations and Assignment

Select the sealing air accessory for the motor type required from the following table

Air-pressure Connector Kit	MNR	for motors	
SUP-M01-MSK	R911306562	MSK030, MSK050, MSK061, MSK071, MSK076, MSK103	MSK040, MSK060, MSK070, MSK075,
SUP-M02-MSK	R911315974	MSK100, MSK131	MSK101,

Fig.7-30: Selection matrix sealing air accessory

7.5.4 Mounting Instructions

Retrofitting of IndraDyn S - SUP-M01-MSK

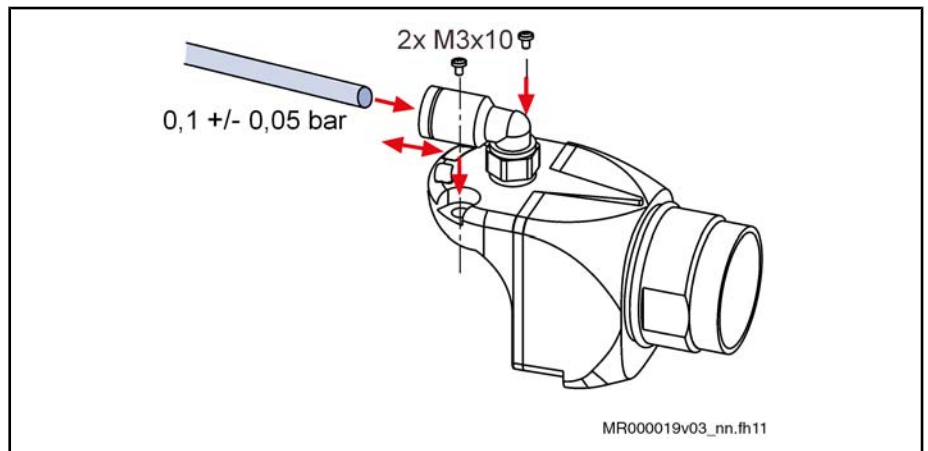

Fig.7-31: RGS1000 with sealing air connection



DANGER

Death by electrocution possible due to live parts with more than 50 V!

⇒ Open machine sockets of the motor only when the system has been de-energized!

1. Open the main switch
2. Ensure that the main switch cannot be accidentally switched on again
3. Loosen the screws of the encoder plug cover and remove the cover.
4. Assemble the air-pressure connector kit



When positioning the cover, ensure that the cable wires and seals are not damaged.

Screw the encoder plug cover with the air-pressure connector kit onto the motor. Tightening torque of the screws 1.3 Nm.

5. Connect the quick-acting pneumatic coupling of the accessory set to the regulated compressed air source.

The sealing air unit is now ready for operation.

Retrofitting of IndraDyn S - SUP-M02-MSK

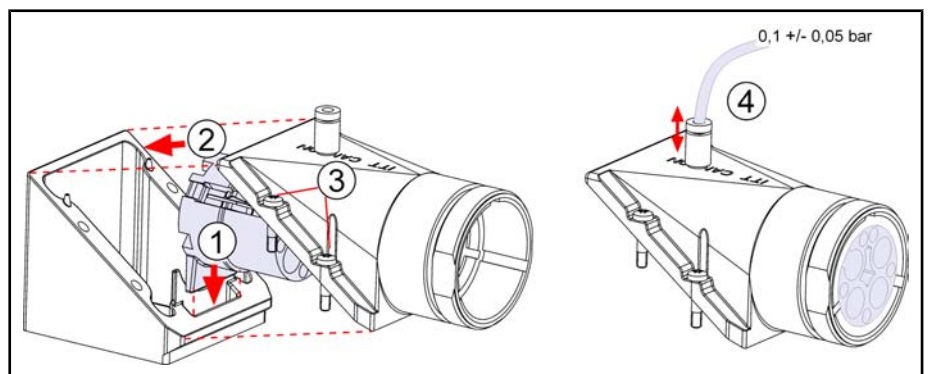

Fig.7-32: RLS1300 with sealing air connection

Accessories and Options



DANGER

Death by electrocution possible due to live parts with more than 50 V!

⇒ Open machine sockets of the motor only when the system has been de-energized!

-
1. Open the main switch
 2. Ensure that the main switch cannot be accidentally switched on again
 3. Loosen the screws of the power connector cover and remove the cover.
 4. Assemble the air-pressure connector kit



When positioning the cover, ensure that the cable wires and seals are not damaged.

Screw the power connector cover with the air-pressure connector kit onto the motor. Tightening torque of the screws 3.1 Nm.

5. Connect the quick-acting pneumatic coupling of the accessory set to the regulated compressed air source.

The sealing air unit is now ready for operation.

8 Connection Technique

8.1 Electric Connection Technique Overview

The electrical connections of IndraDyn S motors are standardized over all frame sizes. IndraDyn S motors are provided with

- a power connector, incl. connection for temperature sensor and holding brake,
- an encoder connection.

Both connectors are designed as plug-in connectors. When ready-made cables of Rexroth are used, a simple, fast and error-free assembly and commissioning is ensured.

The connection diagram applies to all IndraDyn S motors.

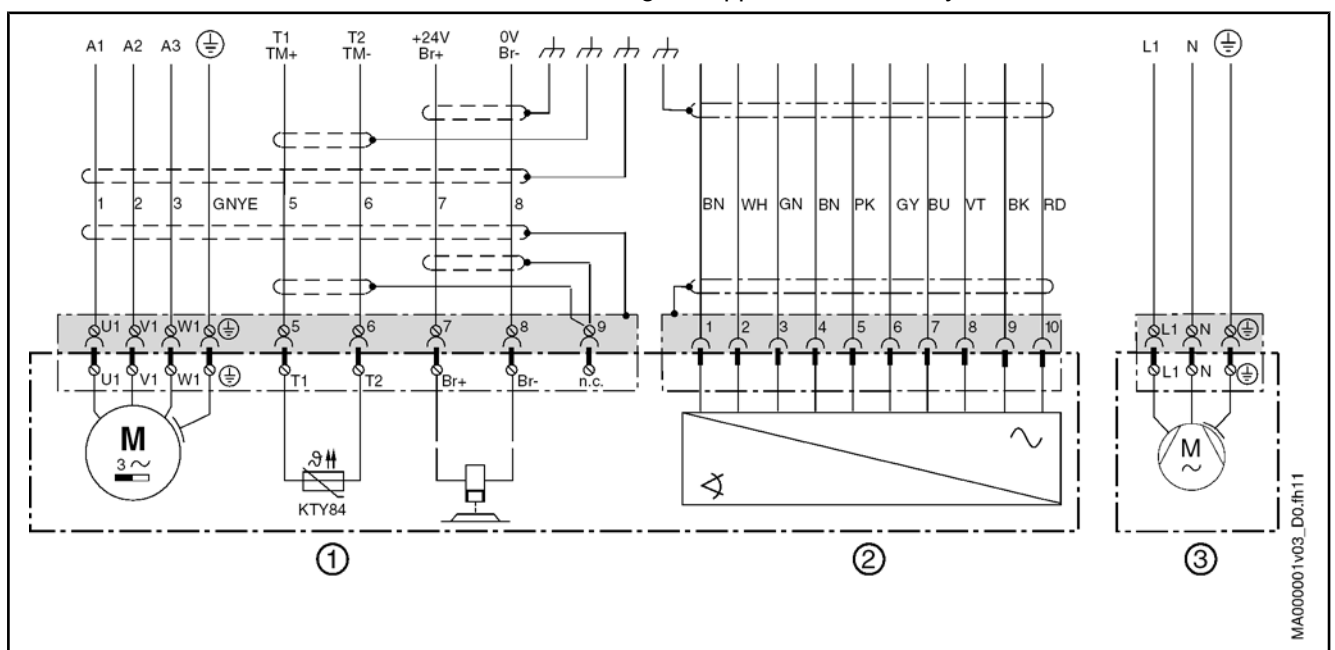

- ① Power connection with temperature sensor and holding brake
- ② Encoder connection
- ③ optional fan connection (operation with a fan unit is not permitted for motors in ATEX design!)

Fig. 8-1: Overview of IndraDyn S connections I

Motor	Power connector	Encoder connector
MSK030	RLS1100	RGS1000
MSK040	RLS1100	RGS1000
MSK050	RLS1100	RGS1000
MSK060	RLS1100	RGS1000
MSK061	RLS1100	RGS1000
MSK070	RLS1200	RGS1000
MSK071	RLS1200	RGS1000
MSK075 ¹⁾	RLS1200	RGS1000
MSK076	RLS1100	RGS1000
MSK100	RLS1300	RGS1003
MSK101	RLS1300	RGS1003
MSK103 ¹⁾	RLS1300	RGS1003
MSK131 ¹⁾	RLS1300	RGS1003

1) Motor not available in ATEX design

Fig. 8-2: Connector on MSK motors

Connection Technique

8.2 Power Connector Size 1

8.2.1 Technical data - RLS1100

Technical data - RLS1100

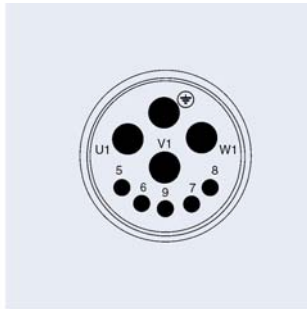
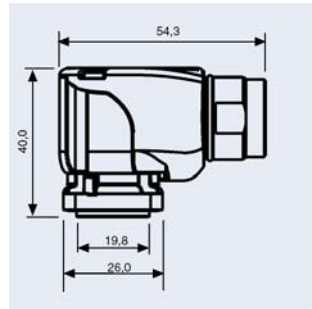

KM000015v01_nn.fh11

Contact assignment

U1, V1, W1	Power
PE	Grounding conductor
5	Temperature sensor KTY84 (T1 TM+)
6	Temperature sensor KTY84 (T2 TM-)
7 (optional)	Holding brake (Br+ / +24 V)
8 (optional)	Holding brake (Br- / 0 V)
9	n.c.

Degree of protection	IP66 / IP67
Temperature range	-40 °C to +125 °C
Ambient temperature in operation	40 °C
Contact type	Pins
Rated voltage	630 V / 125 V
Degree of pollution	3
Overvoltage category	III (according to DIN VDE 0110)

Fig.8-3: Technical data - RLS1100

8.2.2 Technical data - RLS1101

Technical data - RLS1101

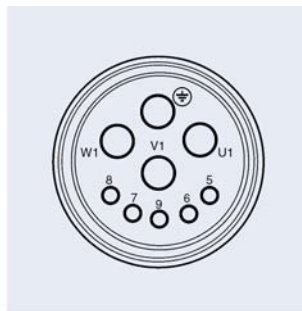
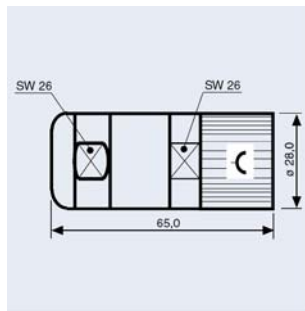

KM000014v01_nn.fh11

Contact assignment

U1, V1, W1	Power
PE	Grounding conductor
5	Temperature sensor KTY84 (T1 TM+)
6	Temperature sensor KTY84 (T2 TM-)
7 (optional)	Holding brake (Br+ / +24 V)
8 (optional)	Holding brake (Br- / 0 V)
9	Shield

Degree of protection	IP66 / IP67	
Temperature range	-40 °C to +125 °C	
Ambient temperature in operation	40 °C	
Contact type	Socket	
Rated voltage	630 V / 125 V	
Rated current	max. 16 A (observe the current rating of the connected cables)	
Degree of pollution	3	
Overvoltage category	III (according to DIN VDE 0110)	
Ordering type	Conductor's cross-section [mm ²]	Terminal area, outer cable diameter [mm]
RLS1101/C02	1,0 / 1,5	11,0 - 14,0

Fig. 8-4: Technical data - RLS1101

Connection Technique

8.2.3 Technical data - RLS1108

Technical data - RLS1108

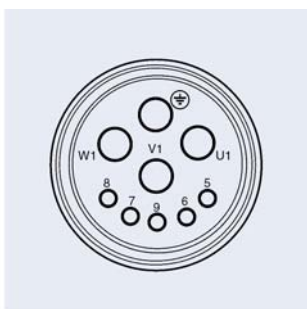
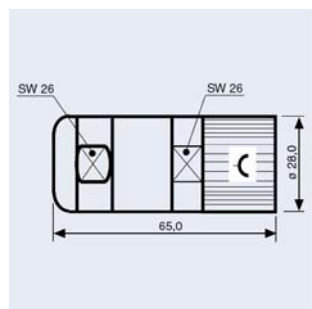

KM000014v01_nn.fh11

Contact assignment

U1, V1, W1	Power
PE	Grounding conductor
5	Temperature sensor KTY84 (T1 TM+)
6	Temperature sensor KTY84 (T2 TM-)
7 (optional)	Holding brake (Br+ / +24 V)
8 (optional)	Holding brake (Br- / 0 V)
9	Shield

Degree of protection	IP66 / IP67
Temperature range	-40 °C to +125 °C
Ambient temperature in operation	40 °C
Contact type	Socket
Rated voltage	630 V / 125 V
Rated current	max. 23 A (observe the current rating of the connected cables)
Degree of pollution	3
Overvoltage category	III (according to DIN VDE 0110)

Ordering type	Conductor's cross-section [mm ²]	Terminal area, outer cable diameter [mm]
RLS1108/C03	2,5	7,5 - 18.0

Fig.8-5: Technical data - RLS1108

8.3 Power Connector Size 1.5

8.3.1 Technical data - RLS1200

Technical data - RLS1200

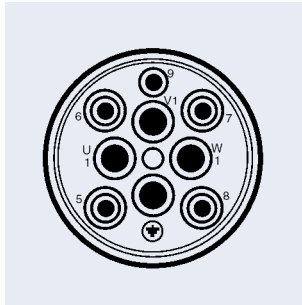
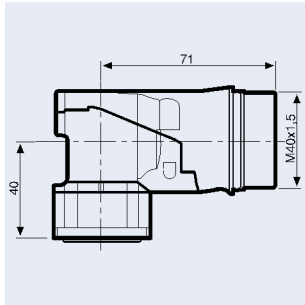

KM000012v02_nn.fh11

Contact assignment

U1, V1, W1	Power
PE	Grounding conductor
5	Temperature sensor KTY84 (T1 TM+)
6	Temperature sensor KTY84 (T2 TM-)
7 (optional)	Holding brake (Br+ / +24 V)
8 (optional)	Holding brake (Br- / 0 V)
9	n.c.

Degree of protection	IP66 / IP67
Temperature range	-40 °C to +125 °C
Ambient temperature in operation	40 °C
Contact type	Pins
Rated voltage	630 V / 125 V
Rated current	57.0 A
Degree of pollution	3
Overvoltage category	III (according to DIN VDE 0110)

Fig. 8-6: Technical data - RLS1200

Connection Technique

8.3.2 Technical data - RLS1201

Technical data - RLS1201

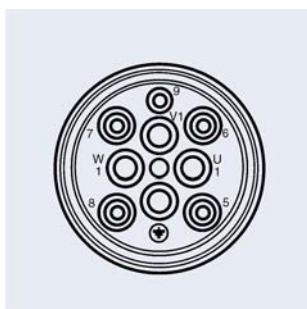
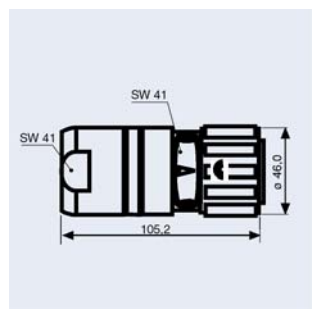

KM000013v01_nn.fh11

Contact assignment

U1, V1, W1	Power
PE	Grounding conductor
5	Temperature sensor KTY84 (T1 TM+)
6	Temperature sensor KTY84 (T2 TM-)
7 (optional)	Holding brake (Br+ / +24 V)
8 (optional)	Holding brake (Br- / 0 V)
9	Shield

Degree of protection	IP66 / IP67
Temperature range	-40 °C to +125 °C
Ambient temperature in operation	40 °C
Contact type	Socket
Rated voltage	630 V / 125 V
Rated current	max. 57 A (observe the current rating of the connected cables)
Degree of pollution	3
Overvoltage category	III (according to DIN VDE 0110)

Ordering type	Conductor's cross-section [mm ²]	Terminal area, outer cable diameter [mm]
RLS1201/C02	1,5	9,0 - 12,7
RLS1201/C04	2,5 / 4,0	13,0 - 17,3
RLS1201/C06	6,0	17,5 - 21,5
RLS1201/C10	10,0	21,5 - 26,0

Fig.8-7: Technical data - RLS1201

8.4 Power Connector Size 2

8.4.1 Technical data - RLS1300

Technical data - RLS1300

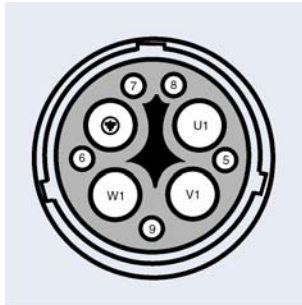
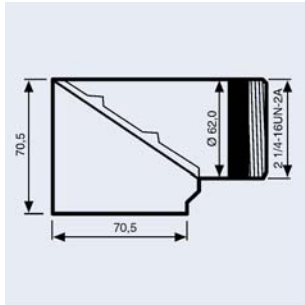

KM000010v01_nn.fh11

Contact assignment

U1, V1, W1	Power
PE	Grounding conductor
5	Temperature sensor KTY84 (T1 TM+)
6	Temperature sensor KTY84 (T2 TM-)
7 (optional)	Holding brake (Br+ / +24 V)
8 (optional)	Holding brake (Br- / 0 V)
9	n.c.

Degree of protection	IP66 / IP67
Temperature range	-40 °C to +125 °C
Ambient temperature in operation	40 °C
Contact type	Pins
Rated voltage	700V
Rated current	100 A (acc. to VDE and UL); 87 A (acc. to CSA)
Degree of pollution	3
Overvoltage category	III (according to DIN VDE 0110)

Fig. 8-8: Technical data - RLS1300

Connection Technique

8.4.2 Technical data - RLS1301

Technical data - RLS1301

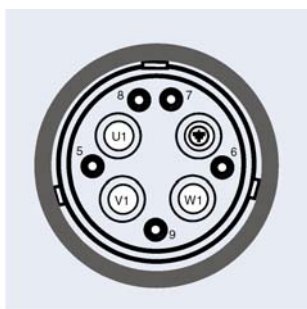
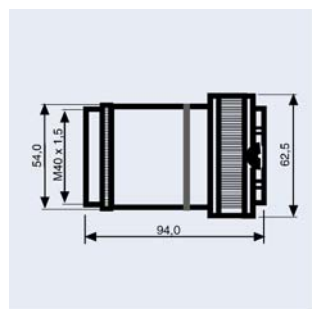

KM000011v01_nn.fh11

Contact assignment

U1, V1, W1	Power
PE	Grounding conductor
5	Temperature sensor KTY84 (T1 TM+)
6	Temperature sensor KTY84 (T2 TM-)
7 (optional)	Holding brake (Br+ / +24 V)
8 (optional)	Holding brake (Br- / 0 V)
9	Shield

Degree of protection	IP66 / IP67
Temperature range	-40 °C to +125 °C
Ambient temperature in operation	40 °C
Contact type	Socket
Rated voltage	700 V
Rated current	100 A (acc. to VDE and UL); 87 A (acc. to CSA) (observe the current rating of the connected cables)
Degree of pollution	3
Overvoltage category	III (according to DIN VDE 0110)

Ordering type	Conductor's cross-section [mm ²]	Terminal area, outer cable diameter [mm] 1)
RLS1301/C03	1.5 / 2.5	Cable gland requirements: <ul style="list-style-type: none"> • Thread 40 x 1.5 • Adapt terminal area to outer cable diameter For further information, please refer to DOK-CONEC-CABLE*STAND-AU□□-EN-P
RLS1301/C06	4.0 / 6.0	
RLS1301/C10	10.0	
RLS1301/C16	16.0	
RLS1301/C25	25.0	

1) Terminal area depends on cable gland used; cable gland not in the scope of delivery

Fig. 8-9: Technical data - RLS1301

8.5 Encoder Connector

8.5.1 Technical data - RGS1000 / RGS1003

Technical data - RGS1000 / RGS1003

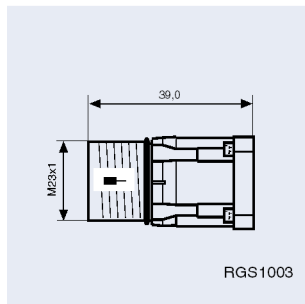
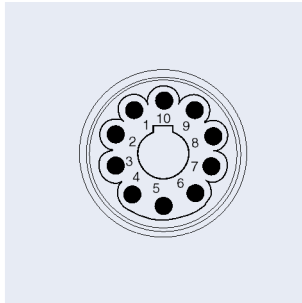
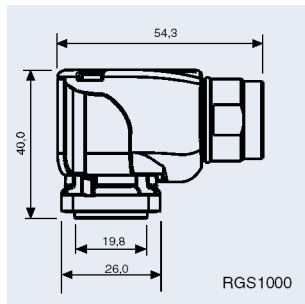

Assignment of encoder contacts

	S1, M1 (Hiperface)	S2, M2 (EnDat2.1)
1	VCC_Encoder	VCC_Encoder
2	GND_Encoder	GND_Encoder
3	A +	A +
4	A -	A -
5	B +	B +
6	B -	B -
7	EncData +	EncData +
8	EncData -	EncData -
9	n.c.	EncCLK +
10	n.c.	EncCLK -

KM000016v01_nn.fh11

Degree of protection	IP66 / IP67
Temperature range	-40 °C to +125 °C
Ambient temperature in operation	40 °C
Contact type	Pins
Rated voltage	125 V
Rated current	0.5 A
Degree of pollution	3
	III
Overtoltage category	(according to DIN VDE 0110)

Fig. 8-10: Technical data - RGS1000/RGS1003

Connection Technique

8.5.2 Technical data - RGS1001

Technical data - RGS1001

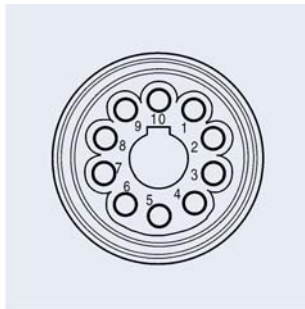
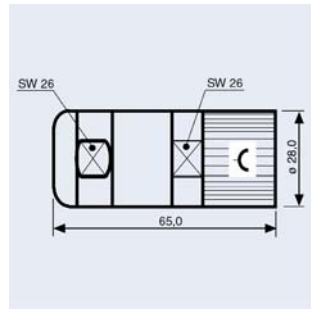

KM000017v01_nn.fh11

Contact assignment

	Rexroth INK0448 wire colors
1	BN 0.5 mm ²
2	WH 0.5 mm ²
3	GN 0.25 mm ²
4	BN 0.25 mm ²
5	PK 0.25 mm ²
6	GY 0.25 mm ²
7	BU 0.25 mm ²
8	VT 0.25 mm ²
9	BK 0.25 mm ²
10	RD 0.25 mm ²
Total shield across connector housing	

Degree of protection	IP66 / IP67	
Temperature range	-40 °C to +125 °C	
Ambient temperature in operation	40 °C	
Contact type	Socket	
Rated voltage	125 V	
Rated current	0.5 A	
Degree of pollution	3	
Overvoltage category	III (according to DIN VDE 0110)	
Ordering type	Conductor's cross-section [mm ²]	Terminal area, outer cable diameter [mm]
RGS1001/C01	1,0	7,5 - 9,0

Fig.8-11: Technical data - RGS1001

8.6 Connecting Cables

8.6.1 Ready-Made Connection Cables

Connection cable Rexroth provides ready-made power and encoder cables. The following documentation is available to help select cables.



You can find additional information ...

- in the documentation "**Rexroth Connection Cables IndraDrive and IndraDyn**"; **DOK-CONNEC-CABLE*INDRV-AUxx-EN-P**"see **MSK selection list**". All available power and encoder cables, as well as the combinations for IndraDyn S motors, are described there.

8.7 Connection Technique Fan Units

Fan units are designed with a connector with protection class IP 65. Connectors are delivered with the fan units, which must be connected on the customer-side. Please, observe the notes in [chapter 7.3 "Fan Units for MSK Motors" on page 177](#).

8.8 Connection Technique Liquid Cooling

The following motors offer the possibility to liquid-cooling.

- MSK071
- MSK075
- MSK101

The motors have G1/8" connections.

Installation material like tubes and fastening clamps do not belong to the scope of delivery. Choose a supply-tube with correct inner diameter d_i . The following figure shows the connection variants possible.

Connection mode	Drawing			
Tube olive	Motor	Tube olive with R1/8" thread	Tube	Tube clip
Quick coupling	Motor	Coupling with R1/8" thread	Coupling with clamped screw connection	Tube
Clamped connection	Motor	Clamped connection with R1/8" thread	Tube	

Fig. 8-12: Connection variants liquid cooling

Connection Technique

For further information about motor operation with liquid cooling refer to [chapter 9.12.3 "Liquid Cooling"](#) on page 246.

9 Operating Conditions and Application Notes

9.1 Ambient Conditions

9.1.1 Setup Elevation and Ambient Temperature

According to DIN EN 60034-1, the motor performance data specified below are valid for:

- Ambient temperatures 0 ... 40 °C
- Setup elevation 0 ... 1,000 m above sea level

When exceeding the given limits, the performance data of the motors must be reduced.

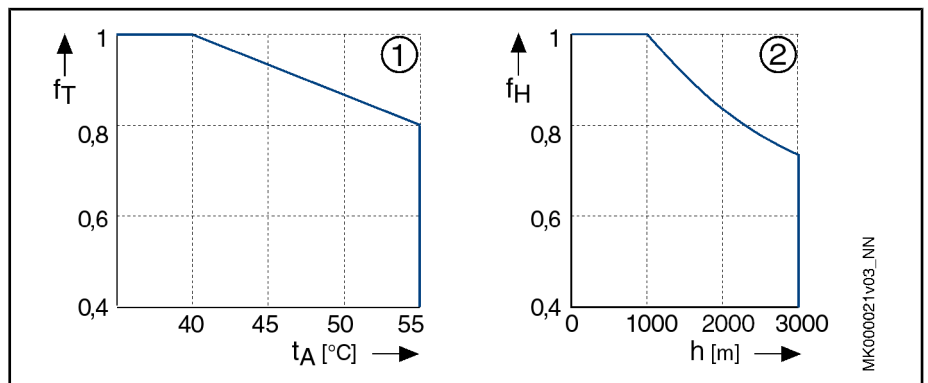

① Utilization depending on the ambient temperature

② Utilization depending on the setup elevation

f_T Temperature utilization factor

t_A Ambient temperature in degrees Celsius

f_H Height utilization factor

h Setup elevation in meters

Fig.9-1: Derating of ambient temperature, setup elevation (in operation)

Calculation of performance data in case the limits specified are exceeded:

Ambient temperature > 40 °C

$$M_{0_red} = M_0 \times f_T$$

Setup elevation > 1,000 m

$$M_{0_red} = M_0 \times f_H$$

Ambient temperature > 40 °C and setup elevation > 1,000 m

$$M_{0_red} = M_0 \times f_T \times f_H$$

Operating Conditions and Application Notes

9.1.2 Humidity / Temperature

Ambient climatic conditions are defined in different classes according to DIN EN 60721-3-3, Table 1. They are based on observations made over long periods of time throughout the world and take into account all influencing quantities that could have an effect, such as the air temperature and humidity.

Based on this table, Rexroth recommends class 3K4 for continuous use of the motors.

This class is excerpted in the following table.

Environmental factor	Unit	Class 3K4
Low air temperature	°C	+5 ¹⁾
High air temperature	°C	+40
Low rel. air humidity	%	5
High rel. air humidity	%	95
Low absolute air humidity	g/m ³	1
High absolute air humidity	g/m ³	29
Speed of temperature change	°C/min	0,5

1) Rexroth permits 0 °C as the lowest air temperature.

Fig.9-2: Classification of ambient climatic conditions according to DIN EN 60721-3-3, Table 1

9.1.3 Vibration

Sinusoidal Vibrations

Sinusoidal vibrations occur in stationary use; depending on their intensity, they have different effects on the robustness of the motors.

The robustness of the overall system is determined by the weakest component.

Based on DIN EN 60721-3-3 and DIN EN 60068-2-6, the following values result for Rexroth motors:

Direction	Maximum permissible vibration load (10-2,000 Hz)	
	Encoder S1, M1	Encoder S2, M2
axial	10 m/s ²	10 m/s ²
radial	30 m/s ²	10 m/s ²

Fig.9-3: Permissible vibration load for MSK motors



Motors with mounted fan units are not suited for applications with continuous shock load, e.g. pressing, squeezing, chargers, ...

In such cases, use motors with higher performance without fan unit or liquid cooled motors.

9.1.4 Shock

The shock load of the motors is indicated by providing the maximum permitted acceleration in non-stationary use, such as during transport.

Damage to functions is prevented by maintaining the limit values specified.

Based on DIN EN 60721-3-3 and DIN EN 60068-2-6, the following values result for Rexroth motors:

Operating Conditions and Application Notes

Frame size	Maximum permitted shock load (6 ms)	
	axial	radial
MSK030 MSK040 MSK050	10 m/s ²	1,000 m/s ²
MSK060 MSK061	10 m/s ²	500 m/s ²
MSK070 MSK071 MSK075 ¹⁾ MSK076	10 m/s ²	300 m/s ²
MSK100 MSK101 MSK103 ¹⁾ MSK131 ¹⁾	10 m/s ²	200 m/s ²

1) Motor not available in ATEX design

Fig.9-4: Permitted shock load for MSK motors

9.2 Degree of Protection

The motors are subdivided into corresponding types of protection (IP) regarding their applicability for different ambient conditions. These types of protection (IP) are described in DIN EN 60529. The protection of the device is characterized by a two-digit number. The **first digit** defines the degree of protection against contact and penetration of foreign particles. The **second digit** defines the degree of protection against water.

1st digit	Degree of protection
6	Protection against penetration of dust (dust-proof); complete contact protection
4	Protection against intrusion of solid foreign bodies, more than 1mm in diameter
2	Protection against intrusion of solid foreign bodies, more than 12.5 mm in diameter
2nd digit	Degree of protection
7	Protection against harmful effects if temporarily immersed in water.
5	Protection against a water jet from a nozzle directed against the housing from all directions (jet water)
4	Protection against water splashing against the housing from all directions (splash water)

Fig.9-5: IP types of protection

The IndraDyn S motor construction corresponds to the following degrees of protection according to DIN VDE 0470, part 1, ed. 11/1992 (EN 60529):

Operating Conditions and Application Notes

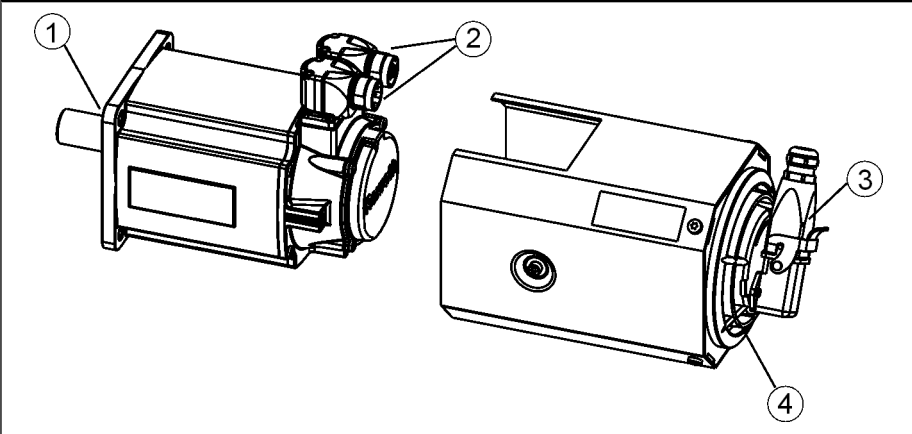

Motor area	Degree of protection	Comment
Motor housing, output shaft, motor connector at professional assembly in connected state	IP 65	Standard design
Motor housing, output shaft, motor connector at professional assembly in connected state and use of sealing air	approx. IP 67	Only with sealing air kit!
Fan motor and connector in connected state	IP 65	Accessory fan unit
Fan grid	IP 24	Accessory fan unit

- ① Output shaft with shaft sealing ring
- ② Connector for power and encoder connection (optionally retrofitable for sealing air)
- ③ Fan motor with connector
- ④ Fan grid

Fig.9-6: IP-protection area with MSK motors



The inspections for the second digit are carried out with fresh water. If cleaning is effected using high pressure and/or solvents, coolants, or penetrating oils, it might be necessary to select a higher degree of protection.

9.3 Design and Installation Positions

Motor design B05		
IM B5	IM V1	IM V3
		
Flange mounting on the drive side of the flange	Flange mounting on the drive side of the flange; drive side pointing down	Flange mounting on the drive side of the flange; drive side pointing up

Fig.9-7: Permissible conditions of installation according to EN 60034-7:1993



Motor damage caused by penetration of fluids!

If motors are attached according to IM V3, fluid present at the output shaft over a prolonged time may enter into and cause damage to the motors.

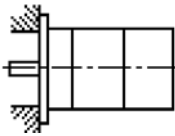
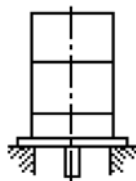
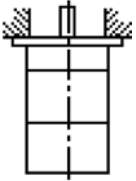
⇒ Ensure that fluid cannot be present at the output shaft.

9.4 Compatibility with Foreign Materials

All Rexroth controls and drives are developed and tested according to the state of the art.

However, since it is impossible to follow the continuing further development of every material with which our controls and drives could come into contact (e.g. lubricants on tool machines), reactions with the materials that we use cannot be ruled out in every case.

For this reason, you must execute a compatibility test between new lubricants, cleansers, etc. and our housings and device materials before using these products.

9.5 Housing Varnish

The housing varnish of the motors consists of a black (RAL9005) 2K epoxy resin coating based on epoxy polyamide resin in water.

Chemical resistance against	Limited resistance against	No resistance against	Additional coat of varnish	
			Standard	Ex / Atex
<ul style="list-style-type: none"> diluted acids/alkaline solutions water, sea-water, sewage current mineral oils 	<ul style="list-style-type: none"> organic solvents hydraulic oil 	<ul style="list-style-type: none"> concentrated acids/brines 	max. 40 µm permissible ¹⁾	not permissible

1) Check the adhesion and resistance of the new paint coat before applying it.

Fig.9-8: Resistance of paint

Operating Conditions and Application Notes

9.6 Output Shaft

9.6.1 Plain Shaft

The recommended standard model for IndraDyn S motors provides a non-positive, zero-backlash shaft-hub connection with a high degree of quiet running. Use clamping sets, clamping sleeves or clamping elements to couple the machine elements to be driven.

9.6.2 Output Shaft with Key

The optional key according to DIN 6885, sheet 1, version 08-1968, permits the form-fitting transmission of torques with constant direction, with low requirements for the shaft-hub connection.

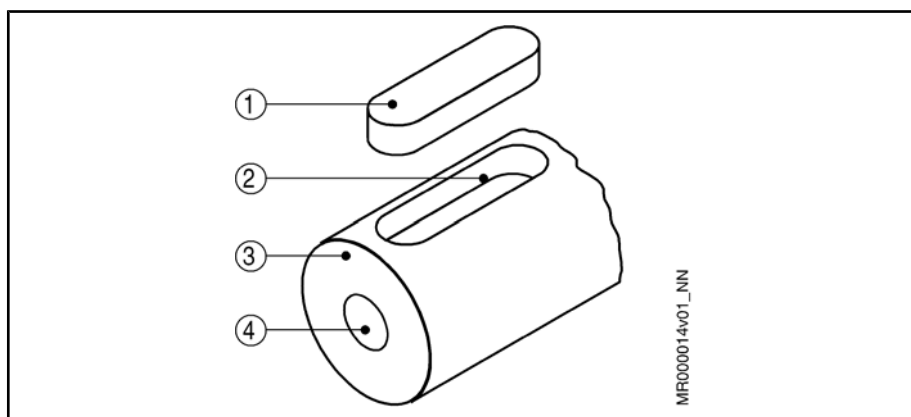

- ① Key
- ② Keyway
- ③ Motor shaft
- ④ Centering hole

Fig. 9-9: IndraDyn S output shaft with key

The machine elements to be driven must additionally be secured in the axial direction via the centering hole on the end face.



CAUTION

Shaft damage! In case of intense reversing operation, the seat of the fitting spring may deflect. Increasing deformations in this area can then lead to breakage of the shaft!

⇒ Preferably, use plain output shafts.

Balancing with a Complete Key

IndraDyn S motors are balanced with the **complete** key. Hence, the machine element to be driven must be balanced without a key.



Modifications to the keys may be made only by the user himself and on his own responsibility. Bosch Rexroth does not assume any warranty for modified keys or motor shafts.

9.6.3 Output Shaft with Shaft Sealing Ring

IndraDyn S motors are designed with radial shaft sealing rings according to DIN 3760 – design A.

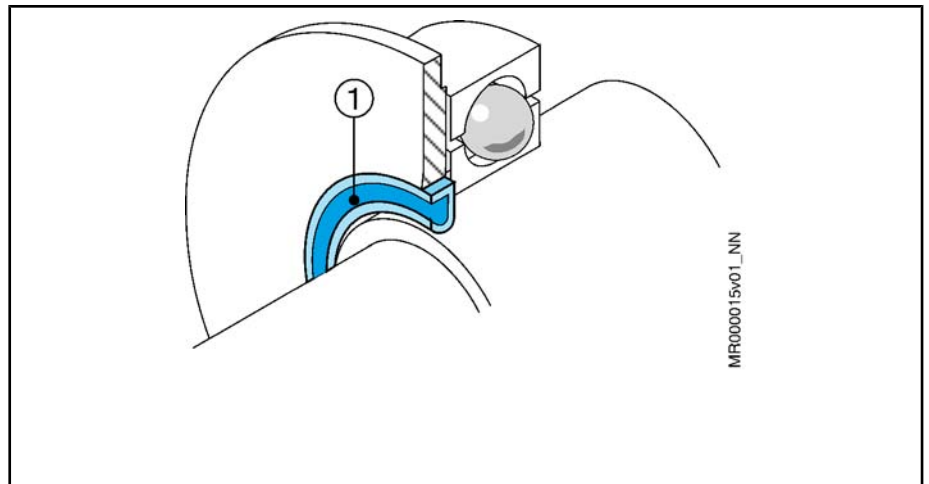

① Radial shaft sealing ring

Fig.9-10: IndraDyn S radial shaft sealing ring

Wear Radial shaft sealing rings are friction seals. Hence, they are subject to wear and generate frictional heat.

Wear of the friction seal can be reduced only if lubrication is adequate and the sealing point is clean. Here, the lubricant also acts as a coolant, supporting the discharge of frictional heat from the sealing point.

- Prevent the sealing point from becoming dry and dirty. Make sure everything is clean.



Under normal environmental conditions, the shaft seal is greased for its lifetime. Under unfavorable environmental conditions (e.g. grinding dust, metal shavings), however, maintenance intervals could be necessary.

Resistance The materials used for the radial shaft sealing rings are highly resistant to oils and chemicals. The performance test for the particular operating conditions lies, however, within the machine manufacturer's responsibility.



The complex interactions between the sealing ring, the shaft and the sealing fluid, as well as the particular operating conditions (frictional heat, soiling, etc.), do not allow calculation of the lifetime of the shaft sealing ring.

**Vertical Installation Positions
IM V3**

The degree of protection on the flange side of motors with a shaft sealing ring is IP 65. Hence, tightness is ensured only in case of splashing fluids. Fluid levels present on the A-side require a higher degree of protection. For vertical installation position (shaft at the top) of the motor, please observe the additional notes in [chapter 9.3 "Design and Installation Positions" on page 231](#).



Rexroth recommends that any direct contact of the drive shaft and the radial shaft sealing ring with the processing medium (coolant, material corrosion) caused by the machine or system construction be avoided.

Operating Conditions and Application Notes

9.7 Bearing and Shaft Load

9.7.1 Radial Load, Axial Load

During operation, both radial and axial forces act upon the motor shaft and the motor bearings. The construction of the machine, the selected motor type and the attachment of driving elements on the shaft side must be adapted to each other to ensure that the load limits specified are not exceeded.

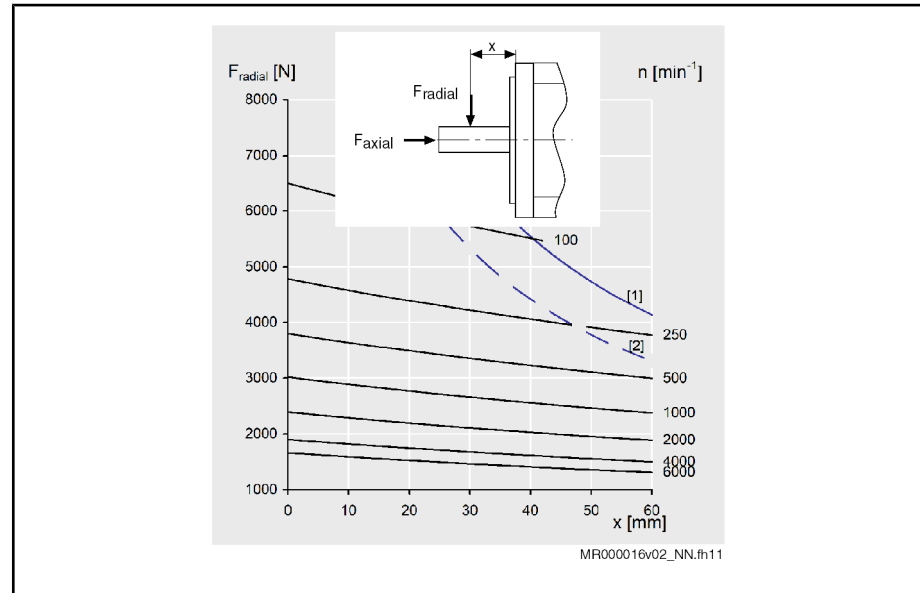

- [1] Shaft, plain
- [2] Shaft with keyway
- n Arithmetic average speed
- x Force application point

Fig.9-11: Example of a shaft load diagram

Maximum Permissible Radial Force

The maximum permissible radial force $F_{\text{radial_max}}$ depends on the following factors:

- Shaft-breaking load
- Point of application of force x (see chapter "Technical Data")
- Shaft design (plain; with keyway)

Permissible Radial Force

The permitted radial force F_{radial} depends on the following factors:

- Arithmetic mean speed (n_{mean})
- Point of application of force x (see chapter "Technical Data")
- Bearing Lifetime

Permissible Axial Force

The maximum permitted axial force F_{axial} is proportional to the radial force. The maximum permissible axial force F_{axial} is indicated in the section on the radial force.

Mean Speed

The initialization and deceleration times can be ignored in the calculation if the time in which the drive is operated at a constant speed is significantly greater than the acceleration and deceleration times. In the exact calculation of the mean speed according to the following example, the run-up and braking times are taken into account.

Operating Conditions and Application Notes

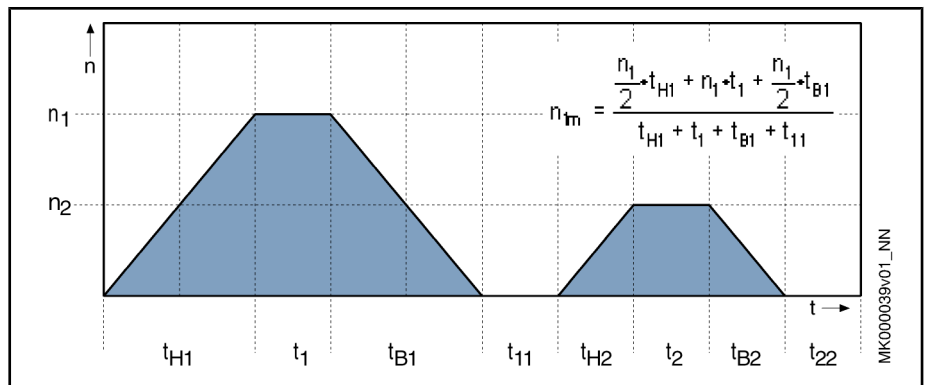

- $n_{1m}; n_{2m}$ Mean speed in section x
- $n_1; n_2$ Processing speed
- $t_{H1}; t_{H1}$ Run-up time
- $t_1; t_2$ Processing time
- $t_{B1}; t_{B2}$ Braking time
- $t_{11}; t_{22}$ Standstill time

Fig.9-12: Mean speed

A complete processing cycle can consist of several sections with different speeds. In this case, the average is to be calculated from all the sections.

Operating Conditions and Application Notes

9.7.2 Shaft Load MSK Motors

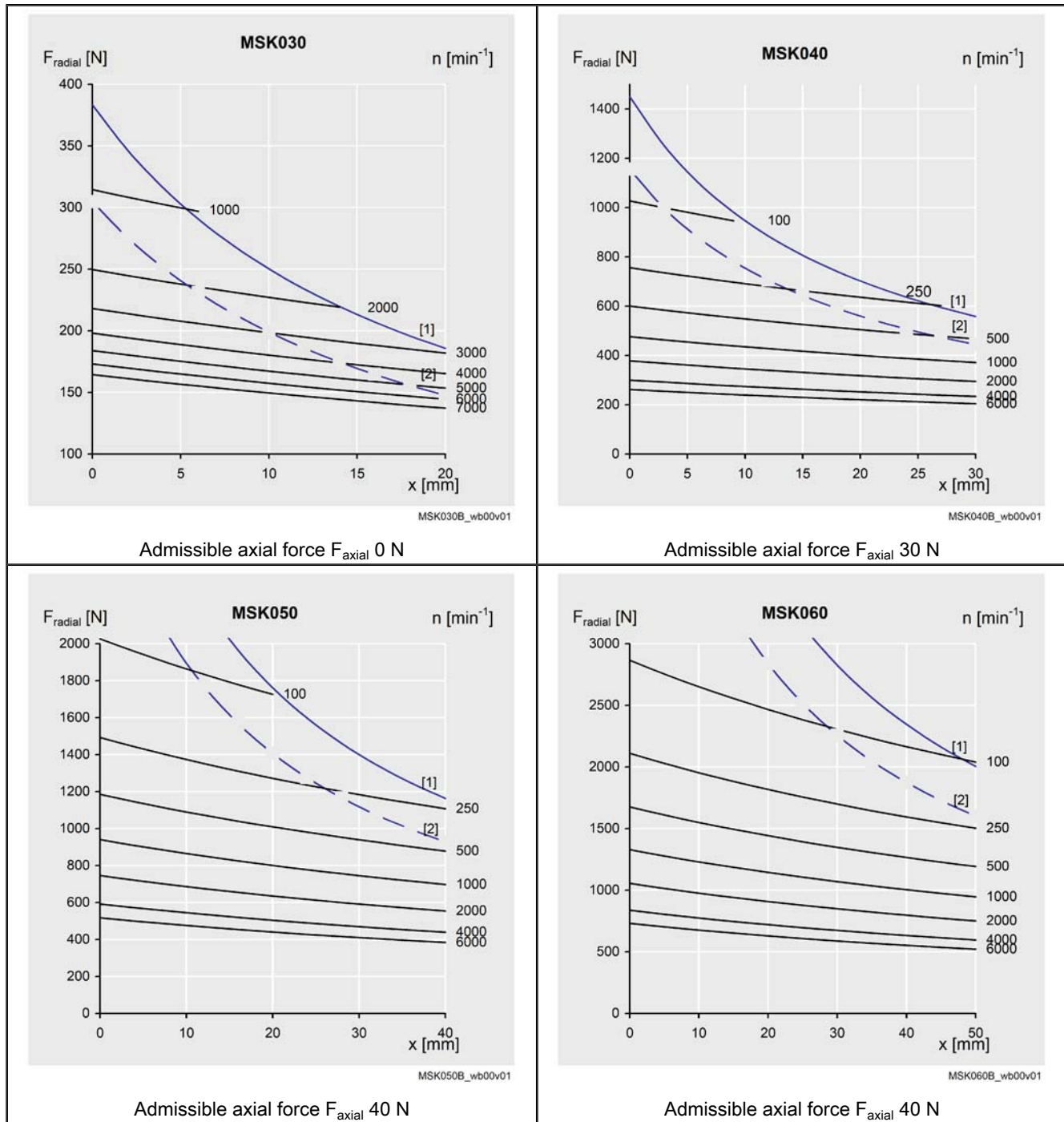

Operating Conditions and Application Notes

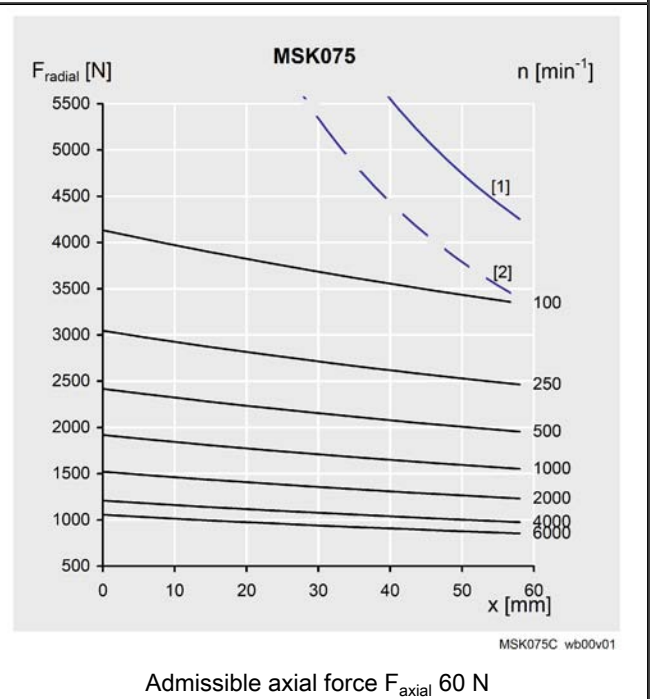
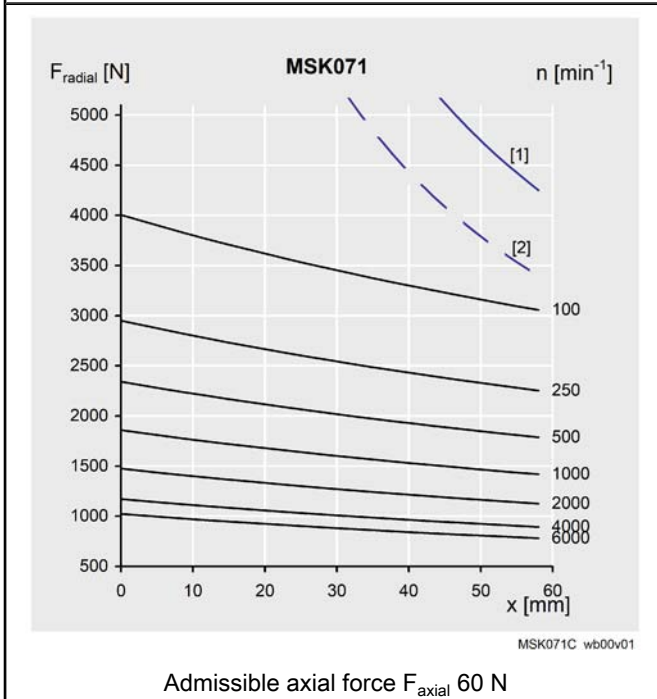
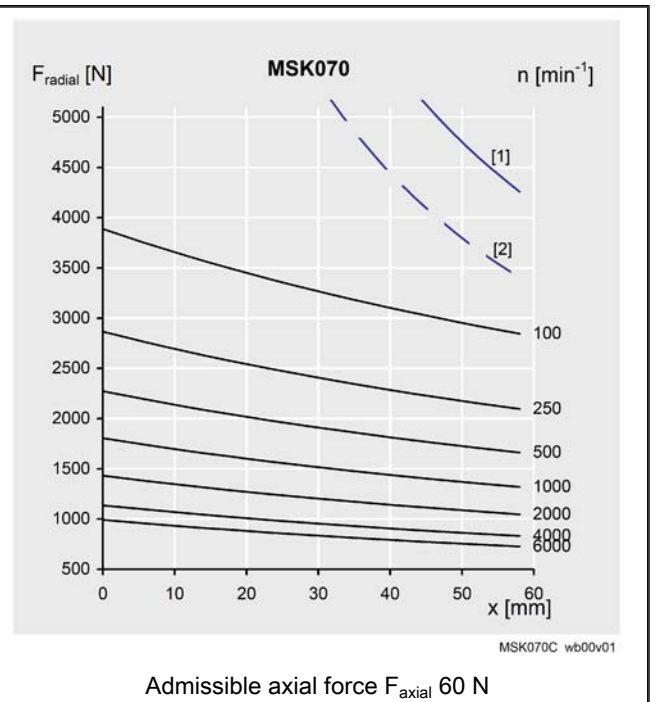
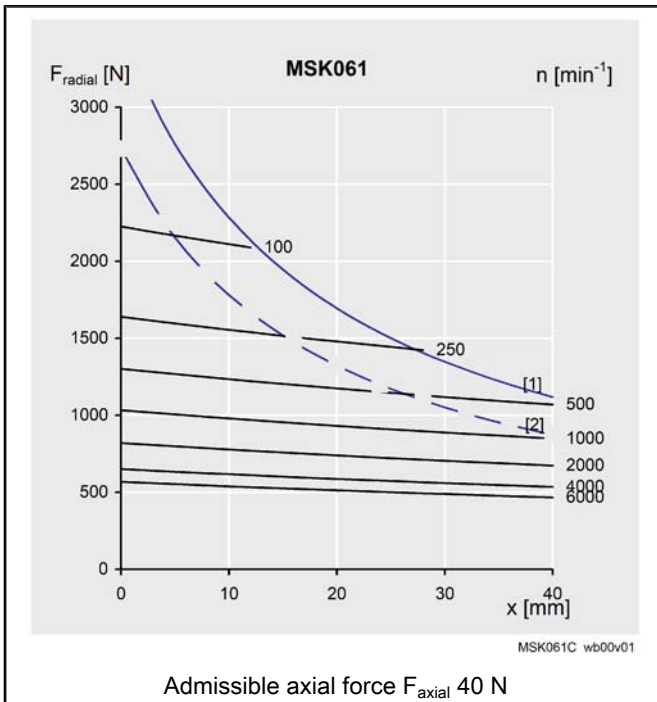

Operating Conditions and Application Notes

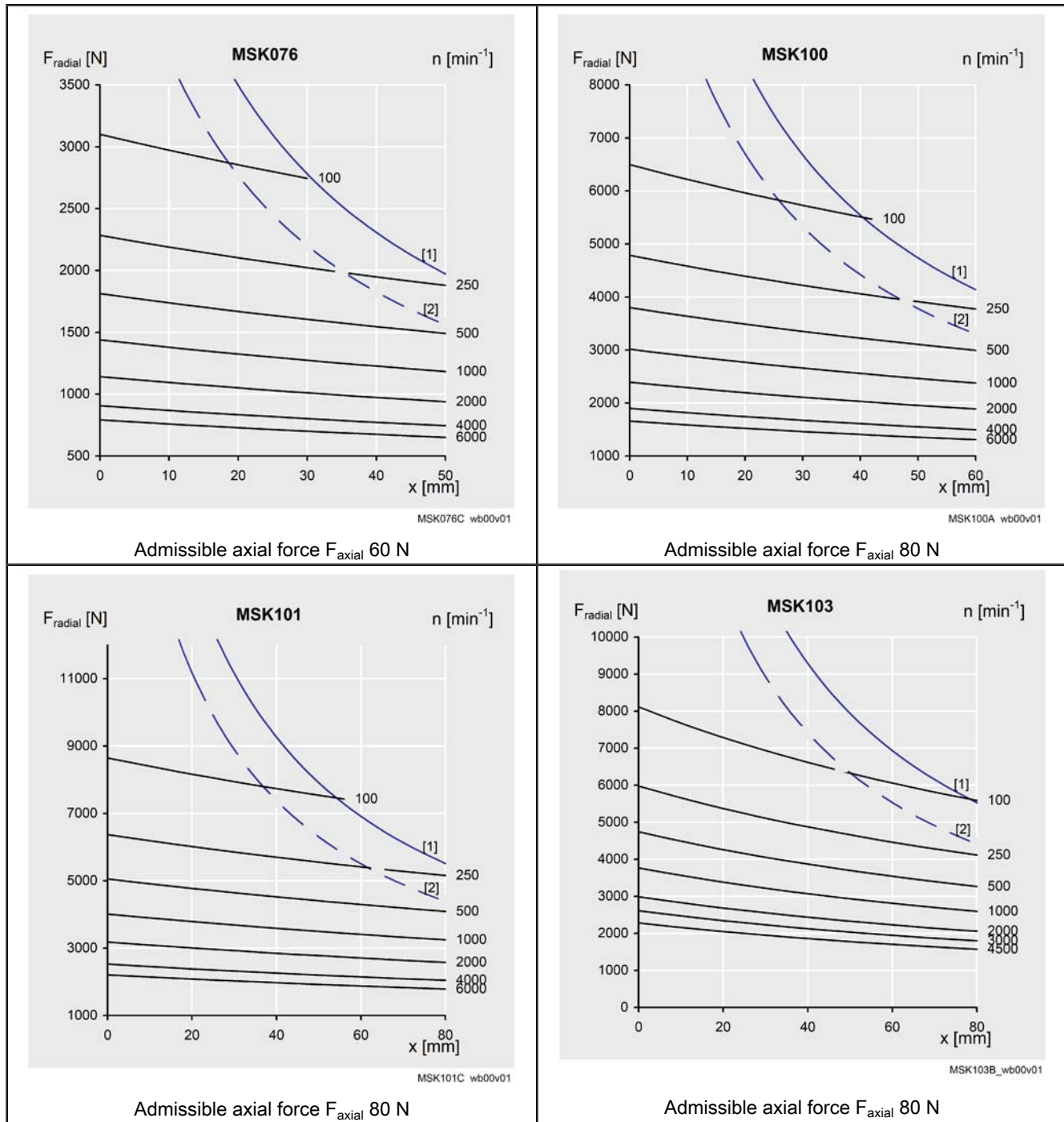

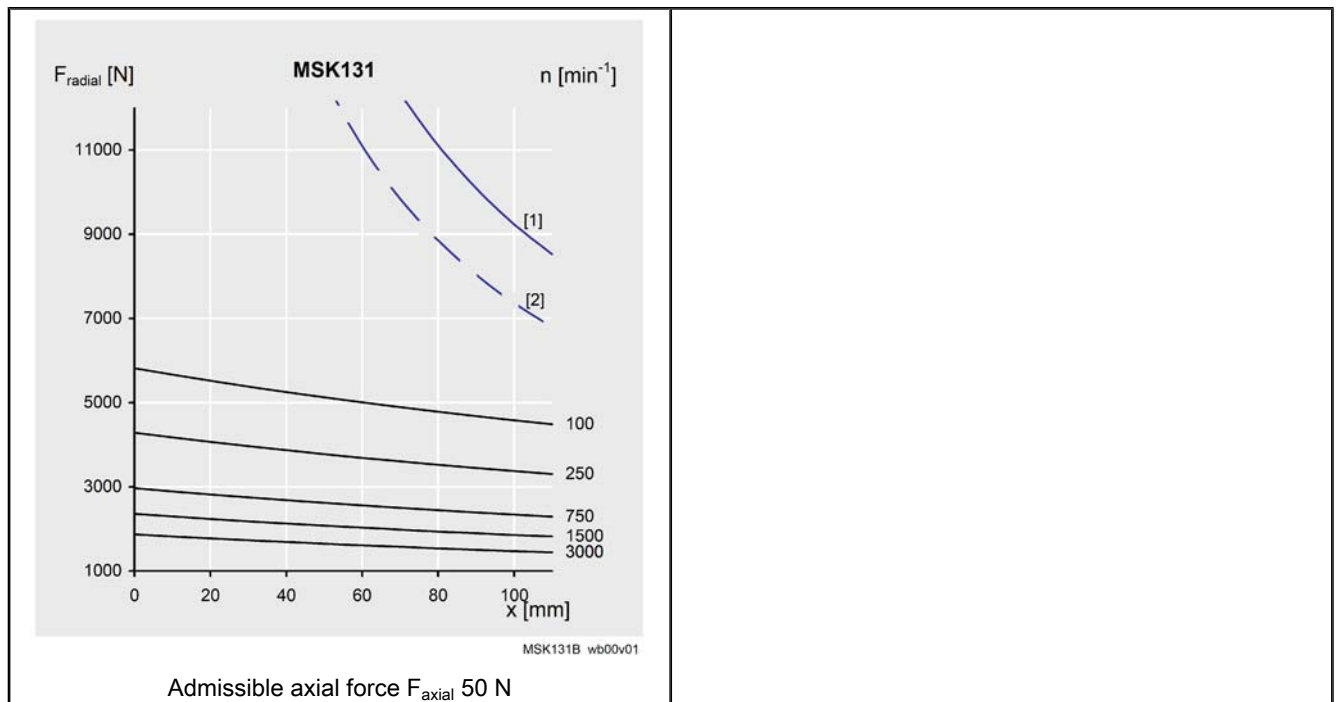

[1] Shaft, plain
 [2] Shaft with keyway
 n [min⁻¹] Mean speed
 Fig.9-13: MSK shaft load

9.8 Bearing Lifetime

The bearing lifetime is an important criterion for the availability of IndraDyn motors.

If IndraDyn S-motors are operated within the limits specified for radial and axial loads, the bearing lifetime is as follows:

Bearing Lifetime $L_{10h} = 30,000$ operating hours

(calculated according to ISO 281, ed. 12/1990)

This applies to all IndraDyn motors based on the following:

- The permitted loads from the corresponding chapter "Technical Data" are never exceeded.
- The motor is operated under the permitted conditions for use and in the permitted ambient temperature range of 0 °C to +40 °C.
- The "mean speed" driven over the entire operating cycle conforms with the characteristic curves from the corresponding section "Technical Data", where:

$$n_m < n_{m(t_F=30000h)}$$

n_m Mean speed
 $n_{m(t_F)}$ Mean speed for which a grease lifetime of 30,000 h can be expected.

Fig.9-14: Mean speed

Differing loads can have the following effects:

- Premature failure of the bearing due to increased wear or mechanical damage.

Operating Conditions and Application Notes

Mechanical Bearing Lifetime in case of Increased Radial Force

- Reduction of the grease lifetime leads to premature failure of the bearing.
- Avoid exceeding the load limits.

In other cases, the bearing lifetime is reduced as follows:

$$L_{10h} = \left(\frac{F_{radial}}{F_{radial_ist}} \right)^3 \cdot 30000$$

L_{10h} Bearing lifetime (according to ISO 281, ed. 12/1990)

F_{radial} Determined permissible radial force in N (Newtons)

F_{radial_act} Actually acting radial force in N (Newtons)

Fig.9-15: Calculation of the bearing service life L_{10h} , if the permissible radial force F_{radial} is exceeded



Under no circumstances may the actually acting radial force F_{radial_act} be higher than the maximum permissible radial force F_{radial_max} .

9.9 Attachment of Drive Elements



CAUTION

Motor damage by intrusion of liquid!

Pending liquids (e.g. cooling lubricants, gearbox oil, etc.) at the drive shaft are inadmissible.

When installing gearboxes please use gearboxes with closed (oil-proof) lubrication system only. Gearbox oil should not be in permanent contact with the shaft sealing ring of the motors.

Whenever attaching drive elements to the output shaft, such as

- Gearboxes
- Couplings
- Gear pinion

please be sure to observe the following notes.

Gearbox mounting on motors

Are gearboxes mounted on motors, the thermal coupling of the motors on machines or constructions changes.

Depending on the gearbox type, the heat development on the gearbox is different. The heat dissipation of the motor via the flange is reduced in every case when a gearbox is mounted. This must be heeded at the project planning.

A reduction of the given performance data is necessary, to do not overload motors when using gearboxes.

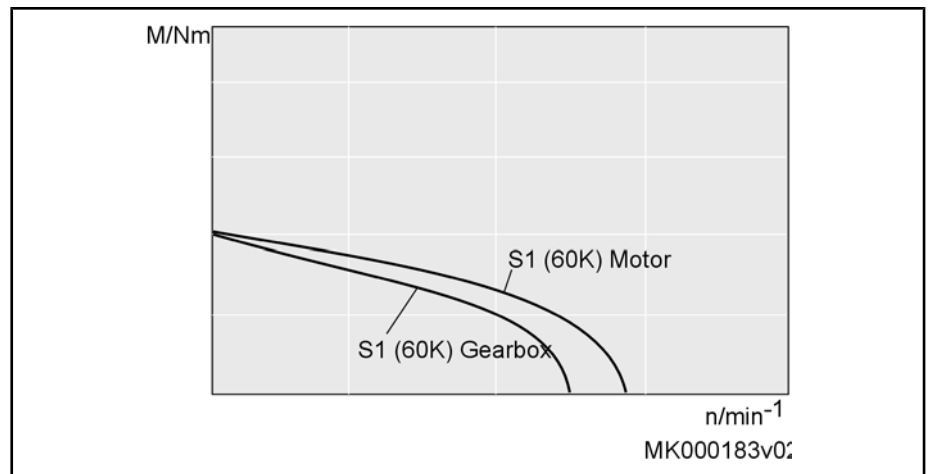

Fig.9-16: S1 characteristic curve of gearboxes



The indicated torques in the characteristic curves of the motor have to be reduced by **10-20%** when mounting gearboxes.

Please, heed all further notes and specifications within this documentation for the used gearboxes.

Overdetermined Bearing

Generally, overtermined bearings are to be avoided by all means when connecting drive elements. The tolerances inevitably present in such cases will lead to additional forces acting on the bearing of the motor shaft and, as the case may be, to a distinctly reduced service life of the bearing.



If redundant attachment cannot be avoided, it is absolutely necessary to consult with Bosch Rexroth.

Couplings

The machine construction and the drive elements used must be carefully adapted to the motor type so as to make sure that the load limits of the shaft and the bearing are not exceeded.



When extremely stiff couplings are attached, the radial force which constantly changes the angular position may cause an impermissibly high load on the shaft and bearing.

Ball bearing pinion or helical teeth drive pinion

Owing to thermal effects, the flange-sided end of the output shaft may shift by 0.6 mm in relation to the motor housing. If helical drive pinions or bevel gear pinions directly attached to the output shaft are used, this change in position will lead to

- a shift in the position of the axis, if the driving pinions are not defined axially on the machine side,
- a thermally dependent component of the axial force, if the driving pinions are defined axially on the machine side. This causes the risk of exceeding the maximum permissible axial force or of the play within the gears increasing to an impermissible degree.
- Damage of the motor bearing on the B-side due to exceeding of the maximum permissible axial force.



In such cases, drive elements should preferably be used with their own bearings which are connected to the motor drive shaft via axially compensating couplings.

Operating Conditions and Application Notes

9.10 Holding Brakes

9.10.1 Holding Brake Electrically-Released

The holding brake of the IndraDyn S motors works according to the principle "electrically-released". Non-operative closed holding brakes open when applying the operating voltage.

The voltage supply of the holding brake has to be designed so as to guarantee under the worst installation and operation conditions that a sufficient voltage is available at the motor in order to ventilate the holding brake. (Please also refer to Rexroth IndraDrive Drive System DOK-INDRV*-SYSTEM*****-PRxx-EN-P, Chapter "Project Planning of Control Voltage ")



The switching voltage arriving on the motor is influenced by the cable length and the cable features, e.g. the conductor resistance.

- We recommend a minimum voltage of 22.8 V (24 V - 5%) onto the drive device for Bosch Rexroth ready-made power cables up to max. 50 m.
- We recommend a minimum voltage of 24.7 V (26 V - 5%) onto the drive device for Bosch Rexroth ready-made power cables longer than 50 m.

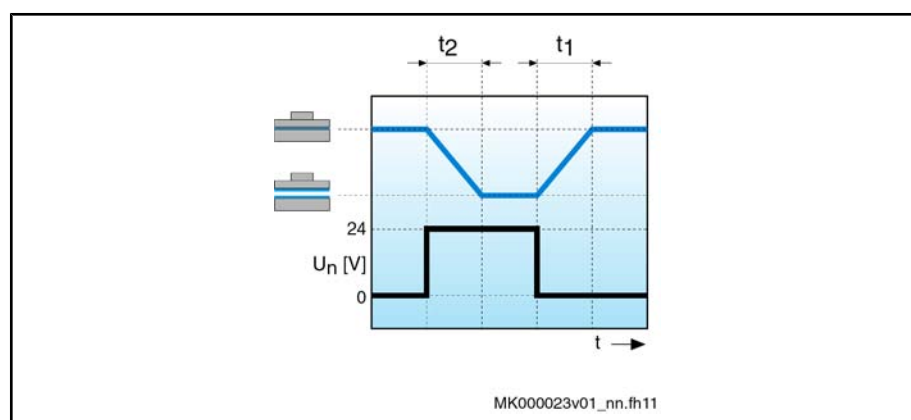

t_1 Connection time
 t_2 Disconnection time

Fig.9-17: Holding brake diagram

The electrically releasing holding brake is used to hold the axes at a standstill and when the "controller enable" signal is off. When the power supply voltage loss and the controller is enabled, the electrically releasing brake will automatically shutdown.



Do not use the holding brake as an operational brake for moving axes.

If the holding brake is engaged repeatedly on a drive in motion or the rated brake torque is exceeded, premature brake wear can occur.

9.10.2 Holding Brakes - Notes Regarding Safety

Observe the safety requirements for the system planning and development.



Personal injury through hazardous movements caused by falling or descending axes!

Secure vertical axes against falling or descending after disconnection:

- lock the vertical axes mechanically,
- provide an external braking / collecting / clamping device, or
- ensure sufficient equilibration of the vertical axes.

The serially delivered holding brakes which are driven by the control device are **not** suited for personal safety!

Personal protection must be realized by superordinate fail-safe measures, such as e.g. the locking off of the danger zone by means of a protective fence or grill.



Observe supplementary standards and recommendations.

For European countries:

- **EN 954 and ISO 13849-1 (2007) and ISO 13849-2 (2003) Safety-related components of controls**
- **Information sheet no. 005 "Gravity-loaded axes (vertical axes)" Edition 02/04 (published by: Fachausschuss Maschinenbau, Fertigungssysteme, Stahlbau)**

For the USA:

- See National Electric Code (NEC), National Electrical Manufacturers Association (NEMA) as well as local building regulations.

The following is generally valid: Comply with all applicable national regulations!

The permanent magnetic brake is no safety brake. This means, a torque reduction by non-influenceable disturbance factors can occur (see EN 954 and ISO 13849-1 (2007) and ISO 13849-2 (2003) or the information leaflet No. 005 about "Gravity-loaded axes (vertical axes)").

Please pay particular attention to the following:

- Corrosion on friction surfaces, as well as dust, perspiration and sediments reduce the braking effect.
- Grease must not hit the friction surface.
- Overvoltage and too high a temperature can weaken the permanent magnets and thus the brake.

Engaging of the brake is no longer ensured, if the air gap between armature and pole is improperly increased due to deterioration. In this case, no braking occurs.

9.10.3 Layout of Holding Brakes

Holding brakes on motors of Rexroth are basically not designed for service braking. The effective braking torques are different in static and dynamic operation for physical reasons.

Operating Conditions and Application Notes

Normal operation and EMERGENCY STOP	Fault condition
<p>In normal operation, using the holding brake for clamping of a standstill axis, the "static holding torque" (M_4) - adhesive friction applies.</p> <p>In case of EMERGENCY STOP for the deactivation of an axis ($n < 10 \text{ min}^{-1}$), a "dynamic holding torque" (M_{dyn}) – sliding friction is effective.</p>	<p>Under a fault condition, using the holding brake for the desactivation of a moving axis ($n \geq 10 \text{ min}^{-1}$), a "dynamic holding torque" (M_{dyn}) – sliding friction is effective.</p>
<p>$M_4 > M_{dyn}$</p> <p>Therefore, note the following description of dynamic sizing.</p>	

Fig.9-18: Dynamic sizing

Dynamic sizing

The load torque must be smaller than the minimum dynamic torque M_{dyn} which the holding brake can provide. Otherwise the dynamic holding brake torque is not sufficient to stop the axes.

If a mass is to be decelerated in a defined time or in a defined route, the additional mass moment of inertia of the whole system must be taken into account.

Project planning recommendation

To ensure the system's safety, reduce the required holding torque to 60% of the static holding torque (M_4) of the holding brake.

9.10.4 Holding Brake—Commissioning and Maintenance Instructions

In order to ensure proper functioning of the holding brake, it must be checked before the motors are commissioned. The test as well as the resurfacing may be carried out "mechanically by hand" or "automatically by means of the software function".

Checking and Resurfacing of Holding Brakes by Hand

Measure the holding torque (M_4) of the holding brake. If necessary, resurface the holding brake.

Measuring the Holding Torque (M_4) of the Holding Brake

1. De-energize the motor and secure it against re-energization.
2. Measure the transferable holding torque of the holding brake with a torque wrench. For holding torque (M_4) refer to the technical data.

If the holding torque (M_4) is achieved, the motor is ready for assembly. If the holding torque (M_4) **is not achieved**, the subsequent resurfacing-process can be used to reconstitute the holding torque.

Resurfacing the Holding Brake

1. At closed holding brake, turn the output shaft by hand, e.g. with the help of a torque wrench, by about 5 revolutions.
2. Measure the holding torque (M_4).

If the holding torque (M_4) is achieved, the motor is ready for assembly. If the specified holding torque (M_4) is not attained after several grinding-in processes, the holding brake is not operable. Please, contact the Rexroth Service.

Checking and Resurfacing of Holding Brakes by means of the Software Function

Checking the Holding Torque (M4) via P-0-0541, C2100 Command Holding system check

1. The efficiency of the holding brake and the opened state are checked by the control device by starting the routine "P-0-0541, C2100 Command Holding system check".

If the holding brake is operational, the drive is in an operational state after the routine was run through. If the braking torque is too low, the control device outputs a corresponding message.



The brake test can also be carried out cyclically in the framework of a preventive maintenance.

Restoring the Holding Torque (M4) by means of the Software Function

The following possibilities are available:

1. Realization of the resurfacing routine IndraDrive "Restoring the holding torque "(see"P-0-0544, C3900 Command Resurfacing of motor holding brake)". A repeated realization of the resurfacing routine is possible.

Upon the execution of the command C3900 it is not checked whether the resurfacing of the holding brake was successful. It is recommended to execute the command C2100 (Command Holding system check) once again.

2. Resurfacing routine by superior control. Here, special control programs adapted to the machine and system concepts are required. If necessary, please contact your Bosch Rexroth distribution partner and discuss the resurfacing routine parameters for your application.



For more detailed information about software functions refer to the functional description "Rexroth IndraDrive Firmware for Drive Control Devices MPx-xx, DOK-INDRV*-MP*-xxVRS**-FKxx-EN-P."

9.11 Acceptances and Authorizations

9.11.1 CE Symbol

Declaration of Conformity

Certificate of conformity confirming the structure of and compliance with the valid EN standards and EC directives are available for all IndraDyn S motors. If necessary, these certificates of conformity can be requested from the responsible sales office.

The CE symbol is attached to the motor type label of IndraDyn S motors.



Fig.9-19: CE symbol

9.11.2 UR, cUR Listing

MSK motors have been presented to the UL authorities "Underwriters Laboratories Inc.®" "Underwriters Laboratories Inc.®"

Operating Conditions and Application Notes

Motors authorized by the UL authorization are labeled with the following sign on the motor type plate, the authorization number of the motors (file number) is given in the technical data.



Fig.9-20: cUR symbol

9.11.3 CCC (China Compulsory Certification)

The CCC test symbol is a compulsory safety and quality label for products distributed in China.

IndraDyn S motors are not liable to certification regarding CCC in China (status when this documentation was printed).

(CCC = China Compulsory Certification)

9.12 Motor Cooling System

9.12.1 Natural Convection

Rexroth motors of the standard design are self-cooling motors. The heat dissipation is realized over the natural convection to the ambient air and heat conduction onto the machine construction.



Pollution of the motors reduces the heat dissipation. Ensure tidiness!

9.12.2 Fan Units

Fan units are deliverable for certain motor types. The power data given in the technical data are labeled with the index "S" for surface You will find a description of the technical data of the available fan units in [chapter 7.3 "Fan Units for MSK Motors"](#) on page 177.

9.12.3 Liquid Cooling

General Information

Rexroth motors in liquid-cooled design are suited for extreme loads, e.g. duration, start, stop-operation with high repetition rates. MSK motors with possible liquid coolant are marked in the type code under point 5 "Cooling mode" with "FN".

Abbrev. Column	1	2	3	4	5	6	7	8	9	0	1	2	3	4	5	6	7	8	9	0	1	2	3	4	5	6	7	8	9
Example	M	S	K	x	x	x	x	x	-	x	x	x	x	-	F	N	-	x	x	-	x	x	x	-	N	N	N	N	

5. Cooling mode
 5. 1 Liquid cooling = FN
 5. 2 Natural convection = NN

Fig.9-21: MSK motors with liquid cooling (type code designation)

The heat dissipation occurs over the used coolant, released via a downstream heat exchanger to the ambient air.

Coolant Ducts

Coolant lines can be designed either as

- pipeline or as
- tubing system.

depending on the corresponding motor.



Owing to the turning points inevitably present in pipeline systems (e.g. 90-degree elbows), high pressure losses develop in the cooling lines. For that reason, we recommend that tubing systems be used.

When selecting the coolant lines, please be absolutely sure to take the pressure drop within the system into consideration. If greater lengths are used, the inside diameter of the lines should, therefore, at least be 9 mm and be reduced only shortly before being connected to the motor.

Operating Pressure

A maximum coolant supply pressure of **3 bar** applies to all MSK motors, regarding the pressure effectively existing directly at the coolant connection of the motor.

Please note that additional screwed or branch connections in the cooling circuit can reduce the flow and supply pressure of the coolant.

Pressure Drop

The flow in the coolant in the drive components is subject to changes in cross-section and direction. For that reason, there are friction and turning losses. These losses show as the pressure drop Δp .

The pressure drop Δp_n of the liquid-cooled motors is specified in the technical data. It relates to the specified flow volume of water as coolant. If the flow volume is converted to a different temperature increase, the pressure drop must be taken from the characteristic curve below.

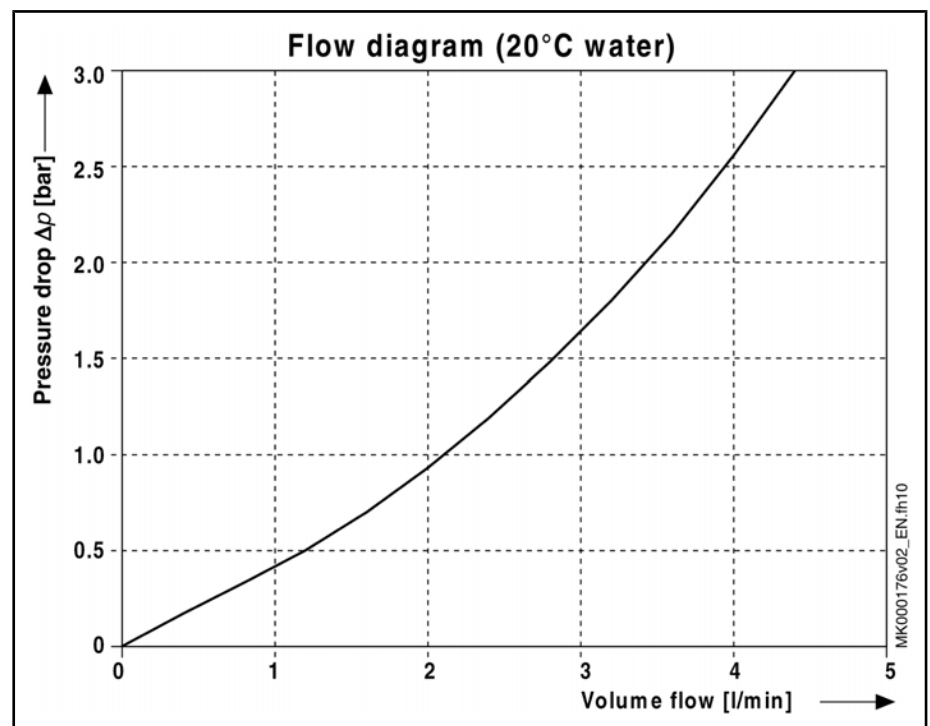

Fig. 9-22: Flow diagram for MSK motors



If a different coolant is used, a different coolant-specific flow diagram is applicable.

Operating Conditions and Application Notes

Coolants

The data specified in the documentation relate to **water as coolant**. If other coolants are used, these data no longer apply and must be recalculated.

Only MSK motors with the option "FN" can be operated via an externally connected cooling system.

The motor power loss P_V is conducted via the coolant. Accordingly, MSK motors may only be operated if coolant supply is ensured. The cooling system must be rated by the machine manufacturer in such a way that all requirements regarding flow, pressure, cleanliness, temperature gradient etc. are maintained in every operating state.



CAUTION

Impairment or failure of motor, machine or cooling system!

⇒ Heed the manufacturer's instructions when constructing and operating cooling systems.

⇒ Do not use any lubricants or cutting materials from operating processes.

A cooling with floating water from the supply network is not recommended. Calcareous water can cause deposits or corrosion and damage the motor and the cooling system.

For corrosion protection and for chemical stabilization, the cooling water must have an additional additive which is suitable for mixed-installations.

Use of aggressive coolants, additives, or cooling lubricants can cause irreparable motor damages.

- Use systems with a closed circulation and a fine filter $\leq 100 \mu\text{m}$.
- Observe the environmental protection and waste disposal instructions at the place of installation when selecting the coolant.

Aqueous Solution

Aqueous solutions ensure reliable corrosion protection without significant changes to the physical properties of the water. The recommended additives contain no materials hazardous to water.

Emulsion with Corrosion Protection

Corrosion protection oils for coolant systems contain emulsifiers which ensure a fine distribution of the oil in the water. The oily components of the emulsion protect the metal surfaces of the coolant duct against corrosion and cavitation. An oil content of 0.5 – 2 volume percent has proved to be of value.

If, in addition to its function of corrosion protection, the corrosion protection oil also assumes the function of lubricating the coolant pump, the oil content must approx. be 5 vol.%.

- Observe the instructions of the pump manufacturer!



Bosch Rexroth can give no general statements or investigations regarding applicability of process-related coolants, additives, or operating conditions.

The performance test for the used coolants and the design of the liquid coolant system are generally the responsibility of the machine manufacturer.

Coolant Additives

Recommended Manufacturers of Coolant Additives

The proper chemical treatment of the closed water systems is precondition to prevent corrosion, to maintain thermal transmission, and to minimize the growth of bacteria in all parts of the system.

Bosch Rexroth recommends using coolant additives of the company NALCO Deutschland GmbH.

Depending on the size of the cooling system, the user may use different additives in form of "ready-to-use cooling water" and "water treatment kits".



The packaging size and the ingredients of the water treatment kit are completely adapted to the corresponding system volume and the user may fill them into the coolant reservoir without observing further mixing ratios.

Ready-to-use cooling water (company NALCO)

System volume in liters	Ordering designation	Additives NALCO...
0,5 ... 50	Nalco PCCL100.11R	PCCL100

Fig. 9-23: Ready-to-use cooling water (company NALCO)

Coolant Water NALCO PCCL100

Nalco PCCL100 is a ready-to-use, preserved cooling water for the use in closed cooling water systems. It is supplied directly to the closed systems and contains all reagents in the proper treatment concentration.

Nalco PCCL100 contains a corrosion inhibitor protecting iron, copper, copper alloys and aluminum against corrosion. Nalco PCCL100 is free of nitrite and minimizes the micro-biological growth.

Water treatment kits (company NALCO)

System volume in liters	Ordering designation	Additives NALCO...
50 ... 100	480-BR100-100.88	TRAC100 7330 73199
100 ... 200	480-BR100-200.88	
200 ... 350	480-BR100-350.88	
350 ... 500	480-BR100-500.88	

Fig. 9-24: Water treatment kits (company NALCO)

Coolant Additive NALCO TRAC100

Nalco TRAC100 is a liquid corrosion and film inhibitor for the use in closed cooling systems. Optionally with TRASAR technology: it monitors, shows and dosages the product automatically to its target concentration and continuously protects the system. NALCO TRAC100 is a complete inhibitor protection iron metal, copper alloys and aluminum against corrosion. NALCO TRAC100 is free of nitrite and minimizes the requirements for micro-biological control.

Coolant additive NALCO 7330

Nalco 7330 is a non-oxidizing broad band biocide and suitable for application in closed cooling circuit systems.

Coolant additive NALCO 73199

Nalco 73199 is an organic corrosion inhibitor supporting a fast own protection layer and covering protection layer for non-ferrous metals.

The above additives are part of the preventive water treatment program by Nalco. It comprises not only the chemicals but also test methods, service and equipment. All these are made available to the user of the products.

The water treatment program is a specification for the user and describes the minimum requirements. Consult Nalco on any additional equipment, tests and services to ensure optimum performance and system protection of the cooling systems.

For additional information and order placement, please contact:

NALCO Deutschland GmbH

Plankstr. 26

71691 Freiberg/Neckar, Germany

Fax +49(0)7141-703-239

Operating Conditions and Application Notes

slund@nalco.com

www.nalco.com



Bosch Rexroth is not in a position to give general statements or carry out investigations regarding applicability of process-related coolants, additives, or operating conditions.

The performance test for the used coolants and the design of the liquid coolant system are generally the responsibility of the machine manufacturer.

Used Materials

When used with MSK motors, the coolant comes into contact with the following materials:

Materials with coolant contact

Flange, end shield	Al Mg 5 F32
Profile	Al Mg Si 0,5 F22
O-ring	Viton

In dimensioning and operating the cooling system, the machine manufacturer has to exclude all chemical or electro-chemical interactions with subsequent corrosion or decomposition of motor parts.

Coolant Inlet Temperature

IndraDyn S motors (option "FN") are designed according to DIN EN 60034-1 for operating with +10...+40 °C coolant inlet temperature. This temperature range must be strictly observed. At higher coolant temperatures, the reduction of the available torque is increased. Because of high coolant temperature gradients, lower temperatures may lead to destruction of the motor.



Install systems in the cooling circuit for monitoring flow, pressure and temperature.

Setting the Inlet Temperature

Observe the temperature range permitted and consider the existing ambient temperature when setting the coolant inlet temperature.

The lower limit of the recommended coolant inlet temperature can be limited in dependence on the existing ambient temperature. To avoid condensation, a value of max. 5 °C below the existing ambient temperature is permitted as the lowest temperature to be set.

	Example 1:	Example 2:
Permitted coolant inlet temperature range:	+10 ... +40 °C	+10 ... +40 °C
Ambient temperature:	+20 °C	+30 °C
Coolant inlet temperature to be set:	+15 ... +40 °C	+25 ... +40 °C



The coolant inlet temperature must be set in a temperature range of +10 ... +40°C and may be only max. 5°C under the existing ambient temperature to avoid condensation.

9.13 Motor Temperature Monitoring

9.13.1 General Information

The motor temperature is monitored by two systems that are operated independently of each other

- Temperature sensor

- Temperature model

and ensures thus the best protection of motors against irreversible damage by thermal overload.

9.13.2 Temperature Sensor

The monitoring of the motor temperature is ensured via the temperature sensor of the KTY84 type, which is built into the stator. The motor temperature measured is controlled via the following threshold values:

- Motor - warning temperature (140 °C)
- Motor - switch-off temperature (150 °C)

The threshold values are filed within the encoder memory of the MSK motors.

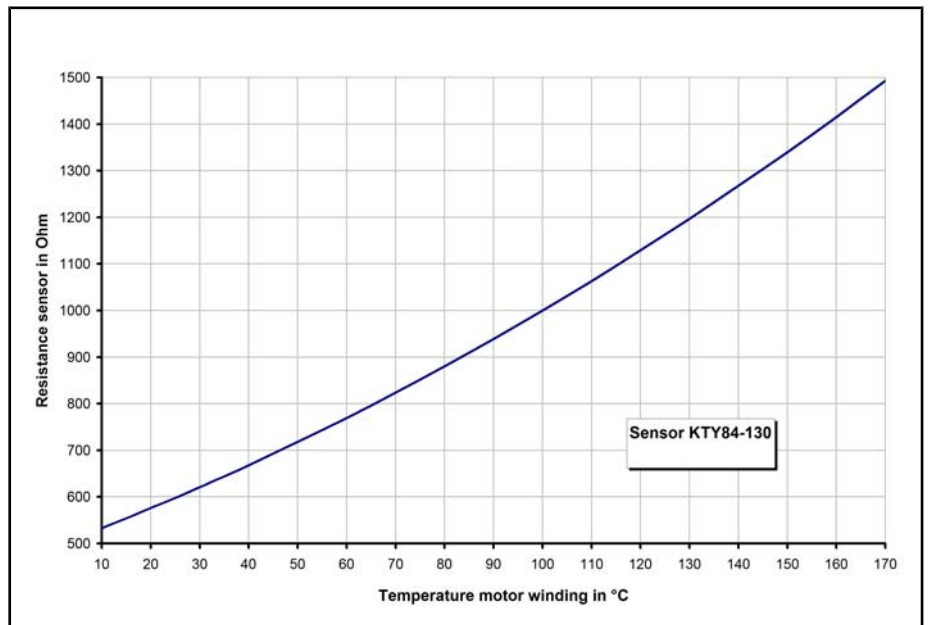

Fig.9-25: Characteristic curve KTY84-130

The IndraDrive control devices monitor the functionality of the temperature sensors.

For further information, please refer to the functional description of IndraDrive control devices.

10 Handling, Transport and Storage

10.1 State of Delivery

10.1.1 General Information

Upon delivery, the IndraDyn S motors are packed in cardboard boxes or crates. Packing units on pallets are secured by means of retaining straps.



WARNING

Injuries due to uncontrolled movement of the retaining straps when cutting!

⇒ Maintain sufficient distance and carefully cut the retaining straps.

Upon delivery from the factory, the motor drive shaft and the connectors have protective sleeves. Remove the protective sleeves just before assembly.

10.1.2 Inspection at the Factory

All IndraDyn S motors undergo the following inspections:

- | | |
|------------------------|---|
| Electrical Test | <ul style="list-style-type: none"> • High-voltage test according to DIN EN 60034-1 / 02.99 • Insulation resistance test according to EN 60204-1/1.92, section 20.3. • Grounding conductor test according to EN 60204-1/1.92, section 20.3. • Test of winding resistance |
| Mechanical Test | <ul style="list-style-type: none"> • Concentricity and position tolerances of shaft end and fastening flange according to DIN 42955/12.81. • Axial eccentricity of the flange face to the shaft according to DIN 42955/12.81. • Coaxiality of the centering shoulder to the shaft according to DIN 42955/12.81. • Test of brake holding torque (option) |

10.1.3 Test Realized by the Customer

Since all IndraDyn S motors undergo a standardized inspection procedure, the customer does not have to carry out any high-voltage tests. Motors and components could be damaged if they undergo several high-voltage inspections.



DANGER

Destruction of motor components due to improperly executed high-voltage inspection! Invalidation of warranty!

⇒ Avoid repeated inspections.

⇒ Please observe the target values of the EN 60034-1 (acc. to DIN VDE 0530-1)

10.2 Identification and Check of the Supplied Goods

10.2.1 Shipping Documents and Delivery Note

The total scope of a delivery can be seen in the delivery note or waybill. However, the contents of a delivery may be distributed over several packages.

Each individual package can be identified using the shipment label attached to the outside.

Handling, Transport and Storage

10.2.2 Type Plate

Each device has an individual type plate showing the device designation and providing technical information.

- After having received the goods, compare the ordered and the supplied type. Immediately report any deviations.

Motor The motor is delivered with its own separate type plate. This is attached to the motor housing. In addition, a second type plate is attached using two-side tape onto the original motor name plate. The second type plate can be attached where visible on the machine, if the original type plate of the motor is concealed by parts of the machine.

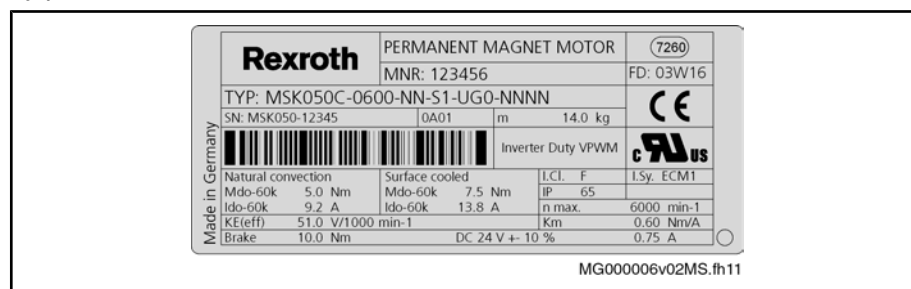

Fig. 10-1: Type label (example: IndraDyn S)

The type plate is provided for

- Identification of the motor
- Procurement of spare parts in case of a fault
- Service information.



The type designation of the motor is also filed in the encoder data memory.

10.3 Handling of the Equipment



Damage or injuries and invalidation of the warranty due to improper handling!

- ⇒ Avoid mechanical stressing, throwing, tipping or dropping of the products.
- ⇒ Use suitable lifting equipment only.
- ⇒ Never lift up the motor on the optional fan housing.
- ⇒ Use suitable protective equipment and protective clothing during transport; wear safety shoes.
- ⇒ Protect the products from dampness and corrosion.

Upon delivery, IndraDyn S motors have protective sleeves and covers on the drive shaft and the flange sockets. During transport and storage, the protective sleeves must remain on the motor.

- Remove the protective sleeves just before assembly.
- Also use the protective sleeves if you return the goods.

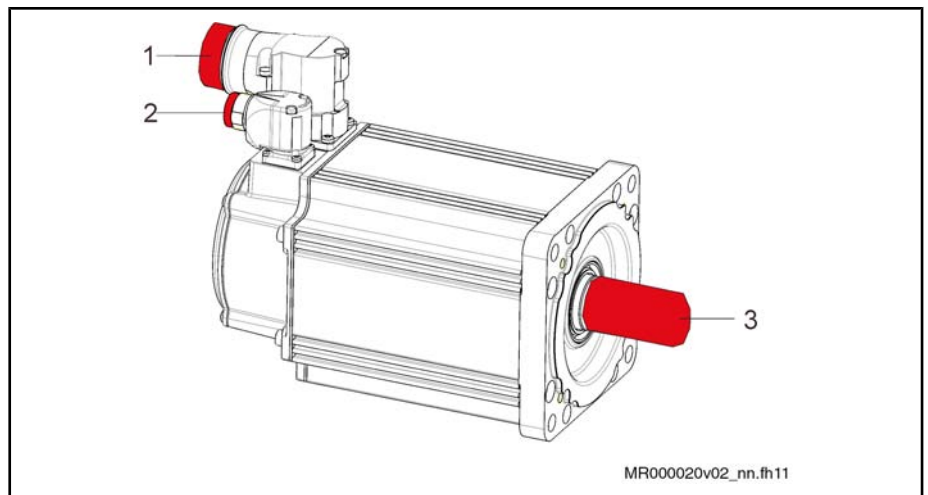

- ③ Power connector protective sleeve
- ② Encoder connector protective sleeve
- ① Shaft protective sleeve

Fig. 10-2: IndraDyn S protective sleeves

- Avoid any damage to the motor flange and drive shaft.
- Avoid impacts to the drive shaft.



Please observe the details regarding axial and radial vibration and shock load in the chapter "Application Notes".

Any impacts to the shaft end damage the encoder and the ball bearings! Drive elements such as pulleys, clutch disks, gears, etc. may be attached or removed only by uniformly heating the drive elements or using suitable mounting or dismantling equipment.

10.4 Transport of the Equipment

Requirements for transport according to DIN EN 60271-3-2.

Environmental factor	Symbol	Unit	Value
Air temperature	T_{transp}	°C	-20 ... 80
Maximum relative air humidity	φ	%	95
Maximum absolute air humidity	ρ_w	g/m ³	60
Keep the shock load limit according to the application notes.			
Empty liquid-cooled motors at a temperature < 4 °C (damage due to freezing).			

Fig. 10-3: Conditions for transport

The following conditions must be maintained during transport:

- Use suitable means for transport and heed the weight of the components. You can find indications of weight in the data sheets or on the type plate of the motor.
- Provide appropriate shock absorbers, if strong vibrations may occur during transport.
- Transport the motors only in the horizontal position.
- Use cranes with lifting sling belts to lift the motors.

Handling, Transport and Storage

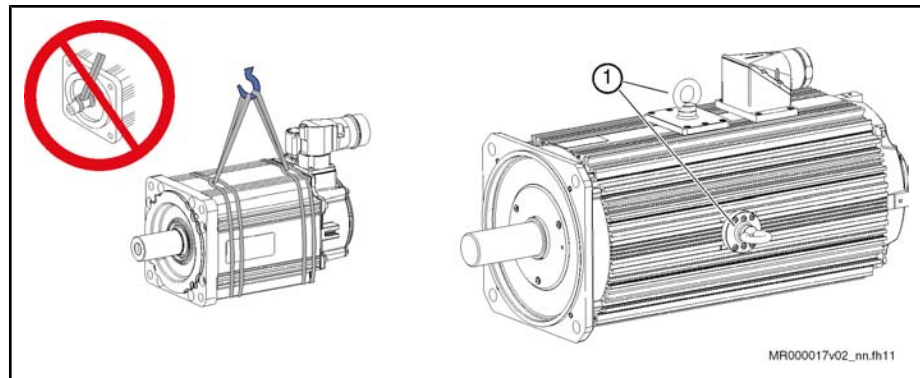

Fig. 10-4: Lifting and transporting motors by means of lifting sling belts

10.5 Storage of the Equipment

Requirements for storage according to DIN EN 60271-3-1.

Environmental factor	Symbol	Unit	Value
Air temperature	T_{lager}	°C	-20 ... 60
Relative air humidity	φ	%	5 ... 95
Absolute air humidity	ρ_w	g/m ³	1 ... 29
Dustfree, dry and with low vibration ($V_{eff} \leq 0.2$ mm/s).			
Empty liquid-cooled motors at a storage temperature < 4 °C (damage due to freezing).			

Fig. 10-5: Conditions for storage



Damage and invalidation of the warranty due to incorrect storage!

⇒ Store the motors horizontally in a dry, vibration-free, dust-free and corrosion-protected location.

11 Installation

11.1 Safety



WARNING

Injuries due to live parts! Lifting of heavy loads!

- Install the motors only when they are de-energized and not connected electrically.
- Use suitable tackles, protective equipment and protective clothing during transport.

Observe the notes regarding safety given in previous chapters.

Carry out all working steps very carefully. In this way, you minimize the risk of accidents and damage.

11.2 Skilled Personnel

Any works on the system and on the drives or in their vicinity must only be carried out by appropriately trained technical personnel.

Please make sure that all persons carrying out

- installation works
- maintenance, or
- operating activities

on the system are adequately familiar with the contents of this documentation as well as with all warnings and precautionary measures contained therein.



Qualified technical personnel are those persons who have been trained, instructed or are authorized to activate and deactivate, ground and mark electric circuits and equipment according to the technical safety regulations. Qualified technical personnel must possess appropriate safety equipment and have been trained in first aid.

11.3 Mechanical Attachment

11.3.1 Flange Assembly

In order to attach the motors correctly and safely to the machine, Bosch Rexroth recommends the following screws and washers for motor mounting.



The screwed connections must be able to take up both the force due to the weight of the motor and the forces acting during operation.

For standard cases, use pan-head machine screw DIN 912 - M... x ... - 8.8 and related washers according to DIN EN 28738. In case of several motors, the integration of washers is not required, see table.



If the screws and washers used do not comply with this recommendation, the property class of the screws and the hardness class must be equivalent in order to transmit the required tightening torques (see [fig. 11-1 "MSK mounting accessories \(flange assembly\)" on page 258](#)).

Installation

IndraDyn S motors are designed for flange assembly (B05). Details on the mounting holes are given in the corresponding dimension sheet. For the fastening, the following general assignment applies:

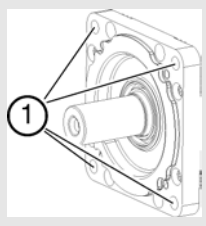
	B05 (flange assembly)			
	Hole	Screw (8.8)		Washer DIN EN 287 38
	Ø [mm]	Type ¹⁾	M _{GA} [Nm]	Ø [mm]
MSK030	4,5	M4×20	3,1	none
MSK040	6,6	M6×20	10,4	none
MSK050	9,0	M8×20	25	10
MSK060				
MSK061				
MSK070	11,0	M10×30	51	12
MSK071				
MSK075 ²⁾				
MSK076				
MSK100	14,0	M12×40	87	14
MSK101				
MSK103 ²⁾				
MSK131 ²⁾	18,0	M16×35	215	none

① Mounting hole

M_{GA} Tightening torque in Newton meters

1) Minimum screw length for screwing into steel.

2) Motor not available in ATEX version.

Fig.11-1: MSK mounting accessories (flange assembly)

11.3.2 Assembly Preparation

- Log all measures taken in the commissioning log.

Prepare motor assembly as follows:

1. Check the components for visible damage. Defective components must not be mounted.
2. Ensure that dimensions and tolerances on the system side are suitable for motor attachment (for details, see the dimension sheet).
3. Ensure that mounting can be done in a dry, clean and dust-free environment.
4. Keep tools and auxiliary material, as well as measuring and testing equipment, ready at hand.
5. Check that all components, mounting surfaces and threads are clean.
6. Ensure that the holder for the motor flange on the machine side has no burrs.
7. Remove the protective sleeve of the motor drive shaft. Retain the sleeve for later use.

8. Check the motors with holding brake, whether the holding brake reaches the holding torque indicated on the data sheet. If the holding brake does not reach the indicated holding torque, proceed as follows [chapter 9.10.4 "Holding Brake–Commissioning and Maintenance Instructions "](#) on page 244.

11.3.3 Motor Assembly

- Mount the motor.

Note:

- Avoid clamping or jamming the centering bundle on the motor side.
- Avoid damage to the insertion fitting on the system side.
- Connect the motor with the machine (observe the tightening torques!).
- Check the fit and accuracy of the connection before you proceed.

After having mounted the motor mechanically as prescribed, establish the electrical connections.

11.4 Electrical Connection – Connecting the Motor

11.4.1 General Information

It is recommended that you use ready-made Rexroth connection cables. These cables provide a number of advantages, such as UL/CSA authorization, extreme load capability and resistance as well as a design suitable for EMC.



DANGER

Danger of life due to electrical power! Handling within the range of live parts is extremely dangerous.

- Any work required on the electric system must only be carried by skilled electricians. It is absolutely necessary to use power tools.
- Before the work can be started, the system must be de-energized and the power switch be secured against unintentional or unauthorized re-starting.
- Before the work can be started, an appropriate measuring device must be used to check whether parts of the system are still under residual voltage (e.g. caused by capacitors, etc.). If yes, wait until these parts have discharged.



WARNING

Injuries to persons or damage to property possible! Interrupting or connecting live lines may cause unpredictable dangerous situations or lead to damage to property.

- Connect and disconnect connectors only when they are dry and de-energized.
- During operation of the system, all connectors must be securely tightened.



WARNING

Risk of short-circuit caused by liquid coolant or lubricant! Short-circuits of live lines may cause unpredictable dangerous situations or lead to damage to property.

- Provide open sides of the power connectors with protective caps, when installing or replacing drive components.

11.4.2 Attaching the Connectors

Power/Encoder Connectors

When fitting the encoder connector with a screwed end fitting, proceed as follows:

Installation

1. Place the power connector in the correct position onto the thread of the connection housing.
2. Tighten the union nut of the power connector manually. By leading the cable in further, the power connector can be steadily brought to its final position.
3. Completely tighten the union nut.



Only completely tightened union nuts guarantee the indicated IP65 protection against water and activate the vibration protection.

11.4.3 Adjusting the Output Direction

The flange sockets can be turned through 240°.

The motor flange socket can be turned if an appropriate connector has been attached. Owing to the leverage of the attached connector, the flange socket can be turned manually to the desired position.

1. Connect the motor power cable to the flange socket.



Do not use any tools (e.g. pliers or screwdrivers) to turn the motor flange socket. Mechanical damage to the flange socket when using tools cannot be excluded.

Move the flange socket to the desired output direction by turning the plugged-in connector.

The desired output direction is set.



Whenever the flange socket is turned, the holding torque in the set position is reduced. To ensure the required holding torque of the flange socket, the output direction should be changed no more than 5 times!

12 Commissioning, Operation and Maintenance

12.1 Commissioning



Damage to property due to errors in the controls of motors and moving elements! Unclear operating states and product data!

- Do not carry out commissioning if connections, operating states or product data are unclear or faulty.
 - Do not carry out commissioning if the safety and monitoring equipment of the system is damaged or not in operation.
 - Damaged products must not be put into operation!
 - Contact Rexroth for missing information or support during commissioning!
-

The following notes on commissioning refer to IndraDyn S motors as part of a drive system with drive and control devices.

Preparation

1. Keep the documentation of all products you are using ready.
2. Check the products for damage.
3. Check all mechanical and electrical connections.
4. Activate the safety and monitoring equipment of the system.
5. Make sure that the optional holding brakes are ready for operation (cf. [chapter 9.10.4 "Holding Brake–Commissioning and Maintenance Instructions"](#) on page 244).

Execution

When all requirements are met, proceed as follows:

1. Activate the optional motor cooling fan unit or liquid cooling.
2. Carry out the commissioning of the drive system according to the instructions provided in the respective documentation. You can find the respective information in the functional description of the drive control devices.



Commissioning of drive controllers and the control unit may require additional steps. The inspection of the functioning and performance of the systems is not part of the commissioning of the motor; instead, it is carried out within the framework of the commissioning of the machine as a whole. Observe the instructions and regulations given by the machine manufacturer.

12.2 Operation

Keep the described ambient conditions during operation (cf. [chapter 9 "Operating Conditions and Application Notes"](#) on page 227).

12.3 Deactivation

In the case of malfunctions or maintenance, or to deactivate the motors, proceed as follows:

1. Observe the instructions of the machine documentation.
2. Use the machine-side control commands to bring the drive to a controlled standstill.
3. Switch off the power and control voltage of the drive controller.

Commissioning, Operation and Maintenance

4. **Only for motors with blowers:** Switch off the motor protection switch for the motor blower.
5. Switch off the main switch of the machine.
6. Secure the machine against accidental movements and against unauthorized operation.
7. Wait for the discharge time of the electrical systems to expire and then disconnect all electrical connections.
8. Before dismounting the motor and - if applicable - the fan unit, secure them against dropping or movement before detaching the mechanical connections.

12.4 Maintenance

12.4.1 General Information

Synchronous motors of the IndraDyn S series operate maintenance-free within the given operating conditions. However, operation under unfavorable conditions can lead to limitations in availability.

- Increase availability with regular preventive maintenance measures. Observe the information in the maintenance schedule of the machine manufacturer and the service measures described below.



WARNING

Burns may be caused through hot surfaces with temperatures over 100 °C

- Do not work on hot surfaces.
- Use safety gloves.
- Let the motor cool down, before maintenance. The thermal time constant stated in the technical data is a measure for the cooling time. A cooling time up to 140 minutes can be necessary!



WARNING

Danger of injury due to moving elements!

- Do not carry out any maintenance measures, while the machine is running.
- During maintenance work, secure the system against restarting and unauthorized use.

12.4.2 Cleaning

Excessive dirt, dust or chips may adversely affect the functionality of the motors and, in extreme cases, even cause a failure of the motors. Clean the cooling fins of the motors at regular intervals (after one year at the latest) to reach a sufficiently high heat emission surface. If the cooling ribs are partially covered with dirt, sufficient heat dissipation via the ambient air is no longer guaranteed.

An insufficient heat radiation may have undesired consequences. The bearing lifetime is reduced by operation at impermissibly high temperatures (the bearing grease is decomposing). Switch-off caused by overtemperature despite operation on the basis of selected data, because the appropriate cooling is missing.

12.4.3 Bearings

The nominal lifetime of the bearings is $L_{10h} = 30,000$ h according to DIN ISO 281, ed. 1990, provided the permissible radial and axial forces are not exceeded.

The motor bearings should be replaced if

- the nominal bearing service life has been reached,

- running noises occur.



We recommend that bearings be replaced by the Bosch Rexroth Service.

12.4.4 Connecting Cables



DANGER

Death by electrocution possible due to live parts with more than 50 V!

- Do not repair any connection lines provisionally. If the slightest defect is detected in the cable sheath, the system must be shut down immediately. Then the cable must be replaced.

- ⇒ Check the connecting cables for damage at regular intervals and replace them, if necessary.
- ⇒ Check any optional energy management chains (drag chains) for defects.
- ⇒ Check the protective conductor connection for proper state and tight seat at regular intervals and replace it, if necessary.

12.5 Troubleshooting

In
preparation

12.6 Dismantling



DANGER

Fatal injury due to errors during the control of motors or works on moving elements!

- Do not work on unsecured and operating machines.
- Secure the machine against accidental movements and against unauthorized operation.
- Before dismantling, secure the motor and power supply against falling or movements before disconnecting the mechanical connections.



WARNING

Burns may be caused through hot surfaces with temperatures over 100 °C.

- Do not work on hot surfaces.
- Use safety gloves.
- Let the motor cool down, before maintenance. The thermal time constant stated in the technical data is a measure for the cooling time. A cooling time up to 140 minutes can be necessary!
- Observe the instructions of the machine documentation.
- Please observe the safety notes.
- Dismantle the motor from the machine. Store the motor properly!

13 Environmental Protection and Disposal

13.1 Environmental Protection

Production Processes	The products are made with energy- and resource-optimized production processes which allow re-using and recycling the resulting waste. We regularly try to replace pollutant-loaded raw materials and supplies by more environment-friendly alternatives.	
Prohibited Substances	We guarantee that our products include no substances according to the chemicals-ban-decree. We furthermore declare that our products are free of mercury, asbestos, PCB and chlorinated hydrocarbons.	
No Release of Hazardous Substances	Our products do not contain any hazardous substances which may be released in the case of appropriate use. Normally, our products will not have any negative influences on the environment.	
Significant Components	Basically, our products contain the following components:	
	Electronic devices <ul style="list-style-type: none"> • steel • aluminium • copper • synthetic materials • electronic components and modules 	Motors <ul style="list-style-type: none"> • steel • aluminium • copper • brass • magnetic materials • electronic components and modules

13.2 Disposal

Return of Products	<p>Our products can be returned to our premises free of charge for disposal. It is a precondition, however, that the products are free of oil, grease or other dirt. Furthermore, the products returned for disposal must not contain any undue foreign material or foreign components.</p> <p>Send the products "free domicile" to the following address:</p> <p style="text-align: center;">Bosch Rexroth AG Electric Drives and Controls Buergermeister-Dr.-Nebel-Strasse 2 97816 Lohr am Main, Germany</p>
Packaging	<p>The packaging materials consist of cardboard, wood and polystyrene. These materials can be recycled anywhere without any problem.</p> <p>For ecological reasons, please refrain from returning the empty packages to us.</p>
Recycling	<p>Most of the products can be recycled due to their high content of metal. In order to recycle the metal in the best possible way, the products must be disassembled into individual modules.</p> <p>Metals contained in electric and electronic modules can also be recycled by means of special separation processes. The synthetic materials remaining after these processes can be thermally recycled.</p> <p>If the products contain batteries or accumulators, these have to be removed before recycling and disposed of.</p>

14 Appendix

14.1 List of Standards

Standard	Edition	Title	Concordance
98/37/EC	1998-06-22	Guideline 98/37/EC of the European Parliament and the Council dated June 22, 1998, for aligning the legal provisions and administrative regulations of the member states for machines	
89/336/EEC	1989-05-03	Guideline of the Council dated May 3, 1989, for aligning the legal provisions of the member states on electromagnetic compatibility	
DIN EN 50178; VDE 0160	1998-04	Electronic equipment for use in power installations; German version EN 50178:1997	EN 50178(1997-10)
DIN IEC 60364-4-41; VDE 0100 part 410	2003-04	Standard draft DIN IEC 60364-4-41 , Edition: 2003-04 Electrical installations of buildings – Part 4-41: Protection for safety; Protection against electric shock (IEC 64/1272/CDV: 2002)	HD 384.4.41 S2(1996-04); IEC 6036-4-41(1992-10)
DIN 332-2	1983-05	Center holes 60° with thread for shaft ends for rotating electrical machines	
DIN 6885-1	1968-08	Driver connection without pick-up; feather keys, grooves, high shape	
DIN EN 60034-1; VDE 0530 part 1	2000-09	Rotating electrical machines - Part 1: Rating and performance (IEC 60034-1:1996, modified + A1:1997 + A2:1999); German version EN 60034-1:1998 + A1:1998 + A2:1999	EN 60034-1(1998-05); EN 60034-1/1(1998-05); EN 60034-1/A2(1999-08); IEC 60034-1(1996-11); IEC 60034-1 AMD 1(1997-06); IEC 60034-1 AMD 2(1999-05)
DIN VDE 0298-4; VDE 0298 part 4	2003-08	Application of cables and cords in power installations - Part 4: Recommended current-carrying capacity for sheathed and non-sheathed cables for fixed wirings in buildings and for flexible cables and cords	
DIN EN 60204-1; VDE 0113 part 1	1998-11	Safety of machinery - Electrical equipment of machines - Part 1: General requirements (IEC 60204-1:1997 + Corrigendum 1998); German version EN 60204-1:1997. In addition, DIN EN 60204-1 (1993.06) is still applicable until 2001.07.01. As a reference standard for EN 60204-3-1 (1990.08), which is published as DIN EN 60204-3-1 (1993.02) in Germany, DIN VDE 0113-1 (1986.02) is still applicable until further notice. DIN VDE 602041 (1993.06) is applicable until further notice as the reference standard for EN 60204-3-1 (1990.08), which has been published in Germany as DIN EN 60204-3-1 (1993.02).	EN 60204-1(1997-12); IEC 60204-1(1997-10)
DIN 42955	1981-12	Tolerances of shaft extension run-out and of mounting flanges for rotating electrical machinery, test	IEC 60072(1971)
DIN 748-1	1970-01	Cylindrical shaft ends for electrical machines	IEC 60072(1971)

Appendix

Standard	Edition	Title	Concordance
DIN EN 60034-14; VDE 0530 part 14	1997-09	Rotating electrical machines - Part 14: Mechanical vibration of certain machines with shaft heights of 56 mm and higher; measurement, evaluation and limits of vibration (IEC 60034-14:1996); German version EN 60034-14:1996	EN 60034-14(1996-12); IEC 60034-14(1996-11)
IEC 721-3-3 replaced by DIN EN 60721-3-3	1995-09	Classification of environmental conditions - Part 3: Classification of groups of environmental parameters and their limits; section 3: Stationary use, weatherproof (IEC 60721-3-3:1994); German version EN 60721-3-3:1995; changed by DIN EN 60721-3-3/A2 dated July 1997	EN 60721-3-3(1995-01); IEC 60721-3-3(1994-12)
IEC 721-1 replaced by DIN IEC 60721-1	1997-02	Classification of environmental conditions - Part 1: Environmental parameters and their severities (IEC 60721-1:1990 + A1:1992 + A2:1995); German version EN 60721-1:1995 + A2:1995	EN 60721-1(1995-04); EN 60721-1/A2(1995-07); IEC 60721-1(1990-12); IEC 60721-1 AMD (1992-12); IEC 60721-1 AMD 2(1995-04)
DIN EN 60529; VDE 0470 Part 1	2000-09	Degrees of protection provided by enclosures (IP code) (IEC 60529:1989 + A1:1999); German version EN 60529:1991 + A1:2000. (In addition, DIN VDE 04701 (1992-11) may still be used until 2003-01-01.)	EN 60529(1991-10); EN 60529/1(2000-02); IEC 60529(1989-11); IEC 60529 AMD 1(1999-11)
DIN EN 60034-7; VDE 0530 part 7	1996-06	Rotating electrical machines - Part 7: Classification of types of constructions and mounting arrangements (IM code) (IEC 60034-7:1992); German version EN 60034-7:1993	EN 60034-7(1993-01); IEC 60034-7(1992-12)
DIN 3760	1996-09	Rotary shaft lip type seals	
DIN ISO 281	1993-01	Rolling bearings; dynamic load ratings and rating life; identical with ISO 281:1990	

Fig. 14-1: List of Standards

15 Service and Support

Our service helpdesk at our headquarters in Lohr, Germany, will assist you with all kinds of enquiries. Out of helpdesk hours please contact our German service department directly.

	Helpdesk	Service Hotline Germany	Service Hotline Worldwide
Time ¹⁾	Mo-Fr 7:00 am - 6:00 pm CET	Mo-Fr 6:00 pm - 7:00 am CET Sa-Su 0:00 am - 12:00 pm CET	Outwith Germany please contact our sales/service office in your area first. For hotline numbers refer to the sales office addresses on the Internet.
Phone	+49 (0) 9352 40 50 60	+49 (0) 171 333 88 26 or +49 (0) 172 660 04 06	
Fax	+49 (0) 9352 40 49 41	–	
e-mail	service.svc@boschrexroth.de	–	
Internet	http://www.boschrexroth.com		
	You will also find additional notes regarding service, maintenance (e.g. delivery addresses) and training.		

1) Central European Time (CET)

Preparing Information

For quick and efficient help please have the following information ready:

- detailed description of the fault and the circumstances
- information on the type plate of the affected products, especially type codes and serial numbers
- your phone, fax numbers and e-mail address so we can contact you in case of questions.

Index

A

Alignment.....	127
Ambient temperature.....	227
Ambient temperature in operation.....	26
Aqueous Solution.....	248
Attachments.....	240
Available motor variants.....	145
Axial load.....	234

B

Balancing.....	127, 232
Ball bearing pinion.....	241
Bearing	
Wear	239
Bearing failure.....	240
Bearing lifetime.....	239
Bearing load.....	234
Brake torque.....	242

C

CCC test symbol.....	246
Centering hole.....	127
CE symbol.....	245
Climatic conditions	228
Compatibility.....	231
Concentricity.....	127
Conditions of installation.....	231
Connecting cables.....	263
Connection plan.....	215
Connection Technique	
Inner diameter	225
Operating pressure	247
Connection techniques	
Operating pressure	247
Connection time.....	26
Contained substances	
see "significant components"	265
Continuous current at standstill, liquid.....	25
Continuous current at standstill 100 K.....	25
Continuous current at standstill 60 K.....	25
Continuous standstill current surface.....	25
Continuous torque at standstill, liquid.....	25
Continuous torque at standstill 100 K.....	25
Continuous torque at standstill 60 K.....	25
Continuous torque at standstill surface.....	25
Coolant additives.....	248
Ready-to-use cooling water	249
Water treatment kits	249
Coolant ducts.....	246
Cooling fins.....	262
Cooling water treatment.....	249
Corrosion Protection.....	248
Coupling.....	241
Couplings.....	240

C

cUR, UR Listing.....	245
----------------------	-----

D

Design.....	231
Discharge capacity of the component.....	25
Disconnection time.....	26
Drag chains.....	263
Drive shaft.....	146
Duty cycle.....	29

E

Energy management chains.....	263
External systems.....	11

F

Fit.....	259
Flange.....	127
Flange assembly.....	257, 258
Foreign materials.....	231
Frame length.....	145
Frame size.....	145

G

Gearboxes	
GTE	211
GTM	211
Gear pinion.....	240
Getriebe.....	240

H

Hazardous substances.....	265
Heat dissipation.....	262
Helical teeth.....	241
Holding brake.....	146
Commissioning	244
electrically-released	242
Holding brakes.....	242
Danger warning	243
Holding torque.....	26
Housing painting.....	127
Housing varnish.....	231
Humidity	
Absolute air humidity	228
Relative air humidity	228

I

Identification.....	254
Inappropriate use	
Consequences, exclusion of liability	13
Installation positions.....	231
Insulation class.....	26

Index

I

Intended use.....	13
IP type of protection.....	229

K

Key.....	127, 232
----------	----------

M

Machine accuracy.....	28
Materials, used.....	250
Maximum current.....	25
Maximum speed.....	26
Maximum torque.....	25
Mean speed.....	234
Moment of inertia of the brake.....	26
Moment of inertia of the rotor.....	26
Motor assembly.....	257, 259
Motor cooling	
Coolants	248
Coolant temperature	250
Motor encoder.....	175
Motor frame size.....	127
MSK030B.....	31
MSK030C.....	33
MSK040B.....	35
MSK040C.....	38
MSK050C.....	41, 44
MSK060B.....	47
MSK060C.....	50
MSK061B.....	53
MSK061C.....	55
MSK070C.....	58
MSK070D.....	61
MSK071C.....	67
MSK071D.....	71
MSK071E.....	75
MSK076C.....	89
MSK100A.....	92
MSK100B.....	95
MSK100C.....	99
MSK100D.....	102
MSK101C.....	105
MSK101D.....	109
MSK101E.....	113
MSK103.....	117, 119, 121
MSK131B.....	123
MSK131D.....	125

N

Non-intended use.....	14
Number of pole pairs.....	25

O

Operating hours.....	239
Operating modes.....	29

O

Output shaft.....	127, 232
Key balancing	146
Plain output shaft	232
Overdetermined bearing.....	241

P

Packaging.....	265
Position resolution.....	175
Pressure drop.....	247
Processing cycle.....	235
Product.....	145
Production processes.....	265
Prohibited substances.....	265

R

Radial load.....	234
Radial shaft sealing ring.....	28
Radial shaft sealing rings.....	232
Rated current.....	26
Rated voltage.....	26
Return of Products.....	265
Running noises.....	263
Run-out.....	127

S

Safety instructions for electric drives.....	15
Sealing air.....	212
Service Hotline.....	269
Setup elevation.....	227
Shaft	
plain	232
with key	232
Shaft end.....	127
Shaft load.....	234
Shaft sealing ring.....	232
Shock.....	228
Shock absorber.....	255
Significant components.....	265
Sinusoidal vibrations.....	228
Sling belts.....	255
Sound pressure level.....	26
Standards.....	10
state of the art.....	13
Storage.....	256
Support	
see Service Hotline	269
Switch-off temperature.....	251
System accuracy.....	175

T

Temperature increase on the housing - 60 K.....	28
Temperature increase on the winding - 100 K.....	28
Temperature sensor.....	251
Thermal time constant.....	26

T

Tightness.....	233
Torque constant.....	25
Transport.....	255
Type of protection.....	229
Type of protection according to IEC 60529.....	26

U

UL authorization.....	245
UL Files.....	25
UR, cUR Listing.....	245

Use

Inappropriate use	14
Intended use	13

V

Varnish.....	231
--------------	-----

V

Vibration.....	228
Vibration severity grade (quality of vibration)....	127
Voltage constant.....	25

W

Warning temperature.....	251
Weight.....	26
Winding.....	145
Winding inductivity.....	25
Winding resistance	25

Notes

Bosch Rexroth AG
Electric Drives and Controls
P.O. Box 13 57
97803 Lohr, Germany
Bgm.-Dr.-Nebel-Str. 2
97816 Lohr, Germany
Tel. +49 (0)93 52-40-0
Fax +49 (0)93 52-48 85
www.boschrexroth.com

