

Ultrasonic sensors

OsiSense XX

Catalogue





Optimise detection with OsiSense XX

Detect all types of objects in all types of applications with **OsiSense™ XX** ultrasonic sensors. These ultrasonic sensors offer an efficient solution for reliable and high performance detection at distances of up to 8m, this being mainly due to the mode window*.

* The mode window enables suppression of the foreground and the background using the same sensor.

> A technology suited to your needs

Detection of all materials

> 3 modes for assuring efficient detection

Detection of all objects irrespective of shape

> Long distance proximity detection

Up to 50 mm for all types of objects

Contents

Customer benefits	2 and 3
Selection guide based on application	4 and 5
Ultrasonic sensors OsiSense XX	
Product selection guide	6 and 7
General	8 to 13
References/characteristics	14 to 21
Accessories	22
Dimensions	23 to 25
Connections	26 and 27
Setting-up	28 and 29

Making sense of sensors SM



> A technology suited to your needs

Ultrasonic sensors enable detection, without contact, of any object in severe industrial environments, irrespective of its:

- material (metal, plastic, wood, cardboard, etc.),
- nature (solid, liquid, powder, paste, etc.),
- colour,
- degree of transparency.

The ultrasonic sensors are simple to install due to their integral connector and availability of cabling and fixing accessories.

100%

of materials detected in all applications

> 3 modes for assuring efficient detection

Diffuse mode

The object reflects the ultrasonic wave back to the sensor which, in turn, changes the output state.

Well suited to flat objects with their surface perpendicular to the ultrasonic beam.

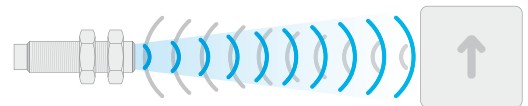

Reflex mode

The sensor is in a permanently detecting state on a fixed background of the machine and when the object to be detected breaks the ultrasonic beam the output changes state. Well suited to objects that absorb the ultrasonic wave (sponges etc.) or which do not reflect the wave back to the receiver (pointed objects or those with non perpendicular faces).

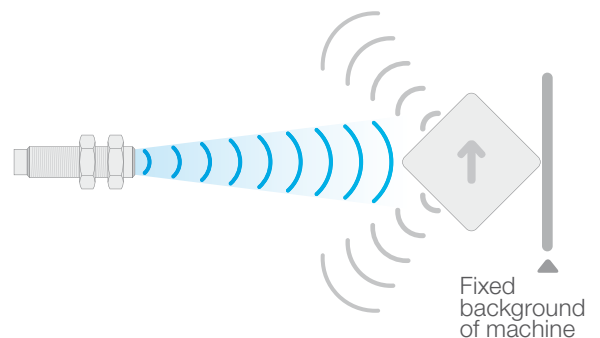

Thru-beam mode

The transmitter permanently transmits the ultrasonic wave to a receiver. The breaking of the ultrasonic beam by the presence of an object changes the output state of the receiver.

Well suited to the detection of small objects, accuracy and high switching frequencies.

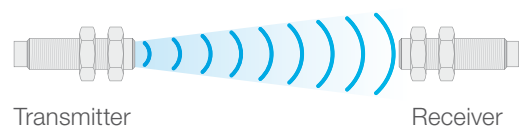

> Long distance proximity detection

The use of ultrasonic technology now makes it possible to obtain much longer detection distances. The new OsiSense XXV Ø18 ultrasonic sensors enable detection from 0 to 50 mm (i.e. 2.5 times more than standard products on the market) irrespective of the environment or object material and colour.

x 2,5
detection distance

In cases where detection distances for moving metal parts are very short, there is always a risk of the sensor being damaged on the slightest impact or knock. Increasing the detection distance of the moving metal parts assures safety of the sensor. Machine downtimes linked to incidents are reduced, as well as maintenance costs. You increase the profitability of your installations!

Osisense XXV Ø18

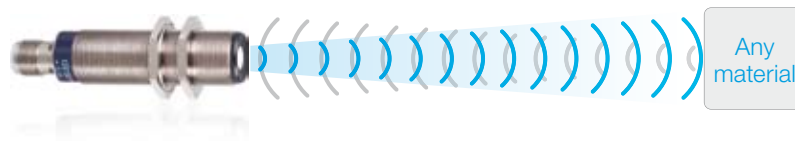

Standard product



The OsiSense XXV ultrasonic sensor is “Plug and Play”, no adjustment required, no teaching. Its solid-state output changes state when the object to be detected is less than 50 mm away.

The fineness and accuracy of its transmission angle enable only the desired object to be detected. Both mutual interference between sensors and edge effects are mastered

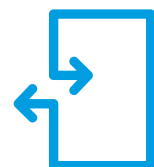

Plug & Play product



100%

Availability throughout the world

> Selection guide based on application

Type of detection

Detection "Digital"

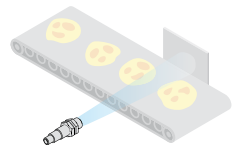
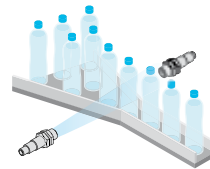
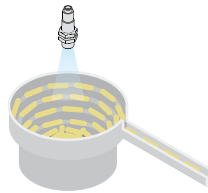

Assembly

Conveying

Machine part

Vibrating bowl

Presence
Absence

Transparent
bottles

Jam

Flow

Sensor type

Ø18
(M18x1)



Ø12
(M12x1)



Ø18
(M18x1)



Ø30
(M30x1,5)



7,6x19x33



16x30x74



18x33x60
Ø18
(M18x1)



80X80X34



Diffuse mode



Reflex mode

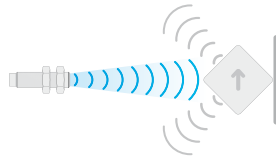

Thru-beam mode



Regulation "Analogue output"

Level monitoring

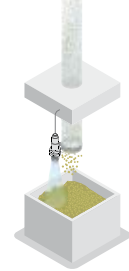
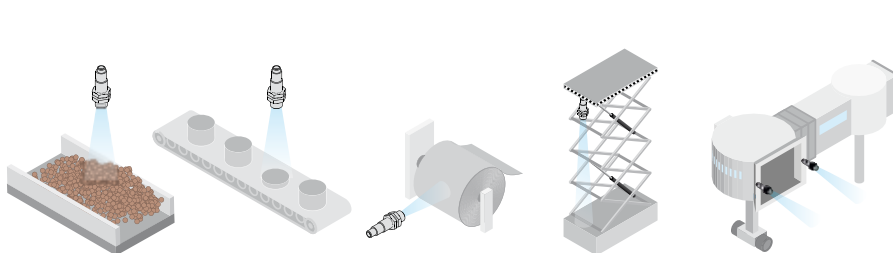
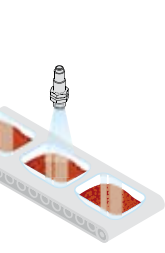

Packaging

Conveying

Packaging

Handling

Handling

Process

Transparent film

Material level

Height of part

Radius of strip roll

Height of elevating table

Aircraft boarding bridge

Monitoring 2 thresholds

Filling Emptying

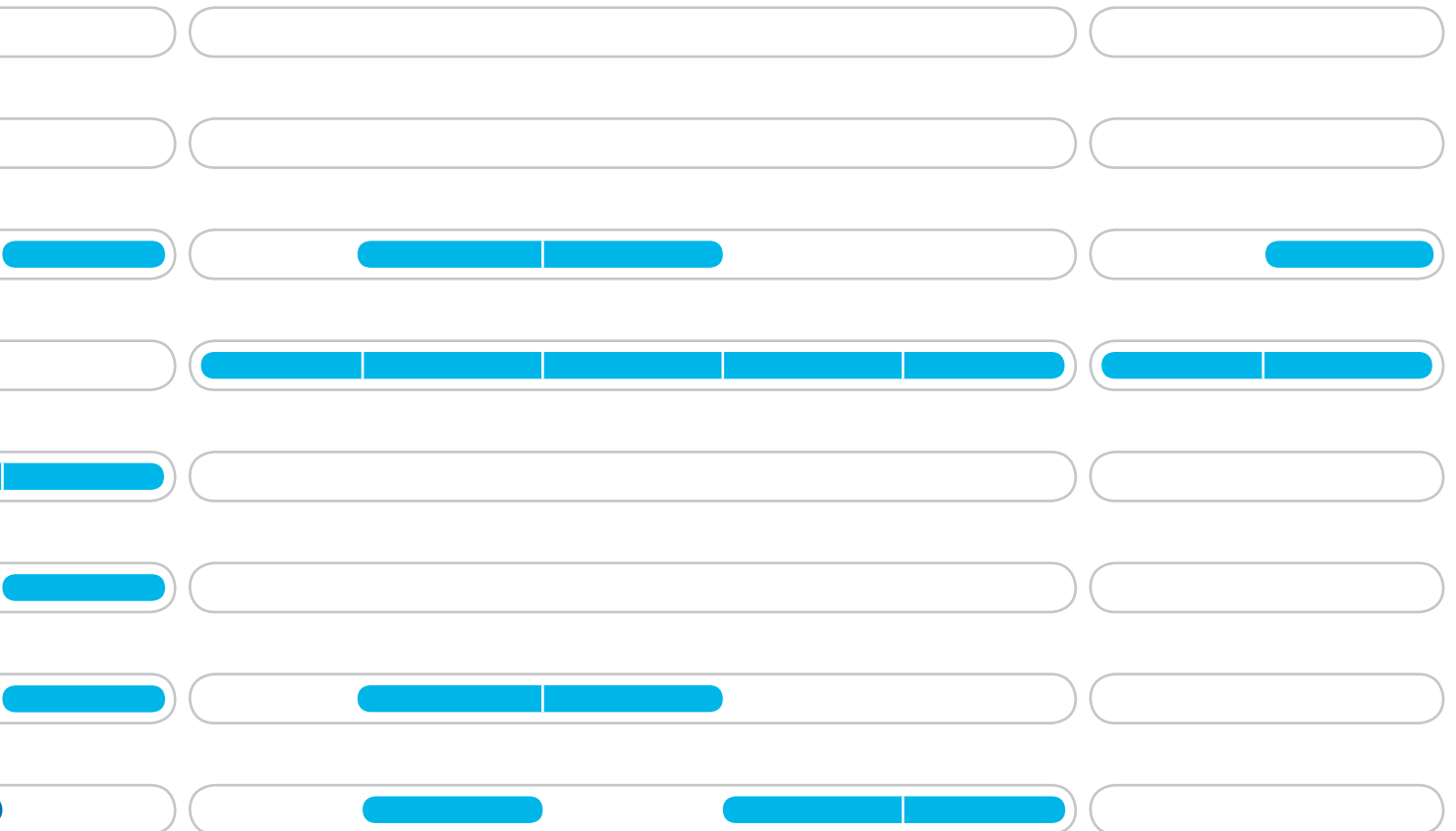

Applications
 Detection of any object, without physical contact, irrespective of: material (metal, plastic, wood, cardboard, etc.), nature (solid, liquid, powder, etc.), colour, degree of transparency, etc.

Dimensions (mm)

Sensors with solid-state digital output

Cylindrical type

Ø 12
(M12 x 1)

Ø 18
(M18 x 1)



Sensing distance Sn

Diffuse

Thru-beam

Assured operating distance (mm)

Type of output

Degree of protection

Function

Connection

Power supply

Sensor type

Pages

5 cm	10 cm	–	5 cm	15 cm	50 cm (adjustable)	–	–
–	–	20 cm	–	–	–	61 cm	1 m
6.4...51 fixed	6.4...102 fixed	0...200 fixed	2...50 fixed	25...152 fixed	Adjustable using teach mode	Fixed	Fixed
PNP/NPN	NPN or PNP	PNP/NPN	PNP or NPN	PNP/NPN	NPN or PNP	PNP/NPN	PNP/NPN
IP 67	IP 67	IP 67	IP 67	IP 67	IP 67	IP 67	IP 67
NO	NO	NO/NC	NO NC	NO	NO	NO NC	NO NC
M8	M8	M8	M12 or pre-cabled	M12	M12 or pre-cabled	M12	M12
12...24 V $\overline{\text{---}}$ with protection against reverse polarity							
XX5 12A1●	XX5 12A2●	XX●12 A8●	XXV 18B1●	XX5 18A1●	XX5 18A3● XX5 18A3●L2	XX●18 A3●	XX●18 A4●
14							

Sensors with analogue output

Cylindrical type

Ø 18 (M12 x 1)

Ø 30 (M30 x 1.5)



Dimensions (mm)

Sensing distance Sn

Assured operating distance (mm)

Type of output

Degree of protection

Connection

Power supply

Sensor type

Pages

50 cm (adjustable)	1 m (adjustable)	2 m (adjustable)	
Adjustable using teach mode	Adjustable using teach mode		
4-20 mA/0-10 V	4-20 mA/0-10 V		
IP 67	IP 65		
M12	M12		
12...24 V $\overline{\text{---}}$ with protection against reverse polarity			
XX9 18A3●	XX9 30A1●	XX9 30S1●	XX9 30A2●
18			

	Cylindrical type		Flat format			
	Application, monitoring 2 levels					
Ø 30 (M30 x 1.5)	Ø 18 (M18 x 1)	Ø 30 (M30 x 1.5)	7.6 x 19 x 33	16 x 30 x 74	18 x 33 x 60 + Ø 18 (M18 x 1)	80 x 80 x 34



1 m/2 m depending on model (adjustable)	8 m (adjustable)		50 cm	1 m/2 m depending on model	10 cm	–	25 cm	–	50 cm (adjustable)	1 m (adjustable)
–	–	–	–	–	–	20 cm	–	61 cm/1 m		
Adjustable using teach mode			Adjustable using teach mode		6.4...102 fixed	0...200 fixed	51...254 fixed	0... 1000 fixed	Adjustable using teach mode	
PNP/NPN or NPN or PNP	PNP or NPN	PNP or NPN	PNP or NPN	PNP/NPN	NPN or PNP	NPN/PNP	NPN or PNP	NPN/PNP	NPN or PNP	NPN or PNP
IP 65	IP 67	IP 65	IP 67	IP 67	IP 67	IP 67	IP 67	IP 67	IP 67	IP 67
NO + NO or NO + NC	NO or NO + NC	NO + NC	NO	NO + NO	NO	NO NC	NO	NO + NO NO + NC	NO	NO
M12	M12	M12	M12	M12	Connector on flying lead	M12	M12	M12	M12	M12

12...24 V $\overline{\text{DC}}$ with protection against reverse polarity

XX6 30A1	XX6 V3A1	XX6 30A3	XX2 18A3●	XX2 30A1●	XX7 F1A2	XX● F1A8	XX7 K1A2	XX● K1A3	XX● K1A4	XX7 V1A1	XX8 D1A1
14			20		16						

Ø 30 (M30 x 1.5)	Flat format	
	18 x 33 x 65 + Ø 18 (M18 x 1)	80 x 80 x 34



1 m (adjustable)	8 m (adjustable)		50 cm (adjustable)		1 m (adjustable)
Adjustable using teach mode		Adjustable using teach mode		Adjustable using teach mode	
4-20 mA	0-10 V	4-20 mA	0-10 V	4-20 mA	0-10 V
IP 67		IP 65		IP 67	
M12		M12		M12	

12...24 V $\overline{\text{DC}}$ with protection against reverse polarity

XX9 V3A1●	XX9 30A3●	XX9 V1A1●	XX9 D1A1●
------------------	------------------	------------------	------------------

18

Quality, standards and certifications

Quality control

The OsiSense XX ultrasonic sensors are subjected to special precautions in order to guarantee their reliability in the most arduous industrial environments.

■ Qualification

A qualification procedure on the characteristics of OsiSense XX ultrasonic sensors is carried out in our laboratories.

■ Production

The electrical characteristics, sensing distances at the ambient temperature and operating temperatures are 100% verified.

Sensors are statistically selected during the course of production and subjected to **monitoring tests** on all qualified characteristics.

■ Customer returns

Returned ultrasonic sensors are subjected to systematic analysis and corrective actions are implemented to eliminate recurrence of the fault.

Conformity to standards

The OsiSense XX ultrasonic sensors conform to the standards IEC 60947-5-2.
Standards and characteristics: refer to pages 15, 17, 19 and 21.

Resistance to chemicals in the environment

To ensure lasting efficient operation, it is essential that any chemicals coming into contact with the ultrasonic sensors will not affect their casing and, in doing so, prevent their reliable operation.

Due to the materials used, OsiSense XX ultrasonic sensors are very resistant to:

■ chemical agents:

salts, aliphatic and aromatic oils,
petroleum, diluted bases and acids.

Depending on their nature and concentration, tests should be carried out beforehand for the following chemical agents:
alcohols, ketones and phenols.

■ food industry products:

vegetable oils, animal fats,
fruit juices,
milk proteins, etc.

Resistance to the environment

■ IP 65: protection against water jets.

Tested in accordance with IEC 60529: the device is subjected to water sprayed from a Ø 6.3 mm nozzle, at a flow rate of 12.5 litres/min for 3 min at a distance of 3 m.
No deterioration in either operating or insulation characteristics is permitted.

■ IP 67: protection against the effects of immersion.

Tested in accordance with IEC 60529: the sensor is immersed for 30 minutes in 1 m of water.
No deterioration in either operating or insulation characteristics is permitted.

Recommendations

The ultrasonic sensors are designed for use in standard industrial applications involving presence detection. Since these sensors do not incorporate a redundant electrical circuit, they are not suitable for use in safety applications. For safety applications, please refer to our "Safety functions and solutions using Preventa" catalogue.

Principle of ultrasonic detection



Presentation

Ultrasonic sensors enable detection, without contact, of any object irrespective of its:

- material (metal, plastic, wood, cardboard, etc.),
- nature (solid, liquid, powder, etc.),
- colour,
- degree of transparency.

They are used in industrial applications for detecting, for example:

- the position of machine parts,
- the presence of the windscreen during automobile assembly,
- the flow of objects on a conveyor system: glass bottles, cardboard packages, cakes, etc.,
- the level
- of different colour paints in pots,
- of plastic pellets in injection moulding machine feeders.

The ultrasonic sensors are simple to install due to their integral connector and availability of cabling and fixing accessories.

Operating principle

The principle of ultrasonic detection is based on measuring the time taken between transmission of an ultrasonic wave (pressure wave) and reception of its echo (return of transmitted wave).

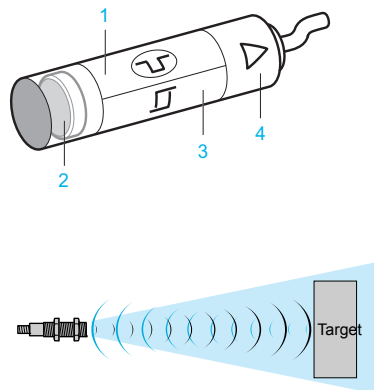

OsiSense XX ultrasonic sensors comprise:

- 1 a high voltage generator
- 2 a piezoelectric transducer (transmitter and receiver)
- 3 a signal processing stage
- 4 an output stage

Excited by the high voltage generator 1, the transducer (transmitter-receiver) 2 generates a pulsed ultrasonic wave (200 to 500 kHz depending on the product) which travels through the ambient air at the speed of sound. When the wave strikes an object, it reflects (echo) and travels back towards the transducer. A micro controller 3 analyses the signal received and measures the time interval between the transmitted signal and the echo. By comparison with the preset or taught times, it determines and controls the output states 4. The output stage 4 controls a solid-state switch (PNP or NPN transistor) corresponding to a NO or NC contact (detection of object).

Advantages of ultrasonic detection

- No physical contact with the object to be detected, therefore, no wear and detection possible of fragile and/or freshly painted objects, etc.
- Detection of any material, irrespective of colour, at the same distance, without adjustment or correction factor.
- Teach mode function, by simply pressing a button, for defining the effective detection zone. Teaching of the minimum and maximum sensing distances (very precise foreground and background suppression, ± 6 mm).
- Very good resistance to industrial environments (robust products entirely encapsulated in resin).
- Solid-state units: no moving parts in the sensor, therefore, service life independent of the number of operating cycles.
- Various types of outputs to suit requirements:
 - Digital output for level control or detection of any type of object
 - Analogue output for controlling systems that require a signal that is proportional to the distance at which the object is detected.

Terminology

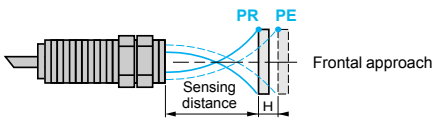
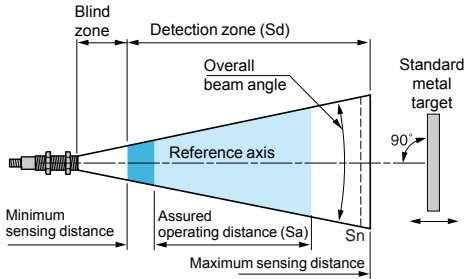

PR = drop-out point
PE = pick-up point

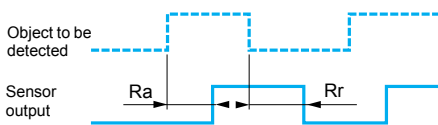
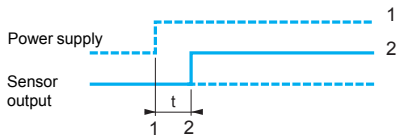
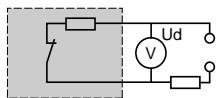

Definitions

The terms listed below are defined by the standard IEC 60947-5-2:

- **Nominal sensing distance (Sn)**
Conventional value for indicating the sensing distance. It does not take into account manufacturing tolerances nor variations caused by external conditions such as voltage and temperature.
- **Detection zone (Sd)**
Zone in which the sensor is sensitive to objects.
- **Minimum sensing distance**
Lower limit of the specified detection zone.
- **Maximum sensing distance**
Upper limit of the specified detection zone.
- **Assured operating distance (Sa)**
This corresponds to the operating zone of the sensor (activation of outputs), and is included in the detection zone. It is also known as the "detection window".
Its limits are fixed:
- at the factory for fixed sensing distance sensors,
- when setting-up within the application for sensors with teach mode.
- **Blind zone**
Zone between the sensing face of the sensor and the minimum sensing distance in which no object can be reliably detected.
Avoid any passing of objects in this blind zone during operation of the sensor. This could lead to instability of the output states.
- **Differential travel**
The differential travel (H) or hysteresis is the distance between the pick-up point as the standard metal target moves towards the sensor and the drop-out point as it moves away from the sensor.
- **Repeat accuracy**
The repeat accuracy (R) is the precision of reproduction between two successive measurements of the sensing distance, made in identical conditions.
- **Overall beam angle**
Fixed angle around the reference axis of an ultrasonic proximity sensor.
- **Standard metal target**
The standard IEC 60947-5-2 defines the standard target as a square metal plate, 1 mm thick with rolled finish, placed perpendicularly to the reference axis.
Its side dimension depends on the detection zone:

Detection zone (mm)	Size of target (mm)
< 300	10 x 10
300 < d < 800	20 x 20
> 800	100 x 100

- **Voltage drop (Ud)**
The voltage drop (Ud) corresponds to the voltage at the terminals of the sensor when in the closed state (value measured at the nominal current of the sensor).

- **First-up delay**
Time required to ensure operation of the sensor's output signal following power-up.
1 Power-up
2 Output signal state (0 or 1)

- **Response time**
Response time (Ra): time taken between the instant the object to be detected enters the active zone and the changing of the output signal state. This time limits the passing speed of the target in relation to its dimensions.
Recovery time (Rr): time taken between the object being detected leaving the active zone and the changing of the output signal state. This time limits the interval between 2 objects.

Digital outputs

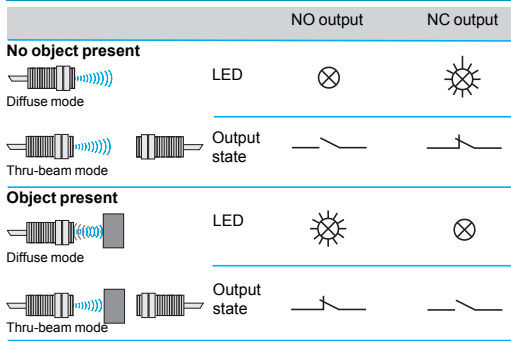

LED indicators

The majority of OsiSense XX ultrasonic sensors incorporate light-emitting diode output state indicators.

- Ø 12 sensor
 - Green LED (power on)
 - Yellow LED (object present)
- Ø 18 sensor, sensitivity 500 mm (except "thru-beam" versions XXT 18 and XXR 18)
 - Yellow (object present) LED or green (power on) LED + user assistance when adjusting the detection zone
- Ø 30 sensor
 - Multicolour LED for assisting the user when adjusting the detection zone
 - Yellow LED (object present)
 - Analogue version with LED (object present, with luminosity increasing as output signal increases)
- Parallelepiped format sensor
 - XX●F: Dual colour yellow (object present) or green (power on) LED
 - XX●V: Dual colour yellow (object present) or green (power on) LED + user assistance when adjusting the detection zone
 - XX7 K: Yellow (object present) LED; green (power on) LED
 - XXT K, XXR K: Yellow (object present) LED
 - XX●D: Yellow (object present) LED; green (power on) LED
 - Analogue version with LED (object present, with luminosity increasing as output signal increases).

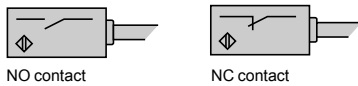

Sensors with digital switching

Output contact logic

- NO contact (normally open)

Corresponds to a sensor whose output changes to the closed state when an object is present in the detection window.
- NC contact (normally closed)

Corresponds to a sensor whose output changes to the open state when an object is present in the detection window.

4-wire technique

NO output/PNP and NPN

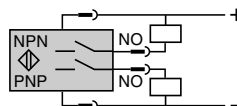

NO + NC output/NPN

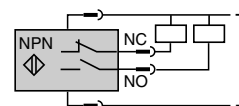

NO + NC output/PNP

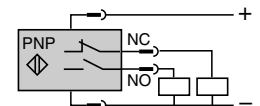

These sensors comprise 2 wires for the supply and 1 wire for each output signal

3-wire technique

NO output/NPN

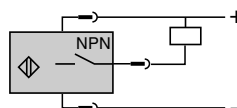

NO output/PNP

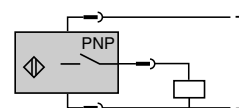

These sensors comprise 2 wires for the supply and 1 wire for the output signal,

- PNP type:** switching the positive side to the load.
- NPN type:** switching the negative side to the load

Sensors with analogue output

Operation

The characteristic feature of these sensors is the output which delivers a signal (either current or voltage) that is proportional to the distance of the object being detected. Within the detection limits, which are adjustable using teach mode, the value of the output signal increases or decreases in relation to the distance of the object. When an object is detected, an LED indicator (D) illuminates and its luminosity increases in relation to the value of the output signal. The slope of the signal can simply be changed by pressing the teach button

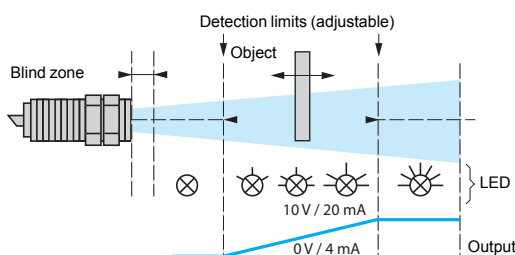

Advantages

- Visual information available relating to the sensor/object distance.
- Protection against reverse polarity.
- Protection against overloads and short-circuits.
- No residual current, low voltage drop.

Power supply

Sensors for DC circuits

- **DC source:** Check that the voltage limits of the sensor and the acceptable level of ripple, are compatible with the supply used.
- **AC source** (comprising transformer, rectifier, smoothing capacitor): The supply voltage must be within the operating limits specified for the sensor.

Where the voltage is derived from a single phase AC supply, the voltage must be rectified and smoothed to ensure that:

- the peak voltage of the DC supply is lower than the maximum voltage rating of the sensor.

Peak voltage = nominal voltage $\times \sqrt{2}$

- the minimum voltage of the DC supply is greater than the minimum voltage rating of the sensor, given that:

$$\Delta V = (I \times t) / C$$

ΔV = maximum ripple: 10% (V),

I = anticipated load current (mA),

t = period of 1 cycle (10 ms full-wave rectified for a 50 Hz supply frequency),

C = capacitance (μ F).

As a general rule, use a transformer with a lower secondary voltage (U_e) than the required DC voltage (U).

Example:

18 V \sim to obtain 24 V \dots ,

36 V \sim to obtain 48 V \dots .

Setting-up precautions

For diffuse sensors:

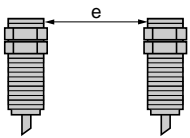

Mounting side by side
 $e \geq 0.3$ at 3 m

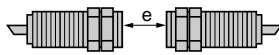

Mounting face to face
 $e \geq 4 S_n$ max.

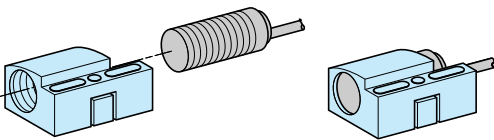
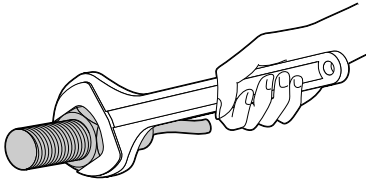

XSZ B100

Mounting

Mounting distance between ultrasonic sensors

If 2 standard sensors are mounted too close to each other, the wave transmitted by one sensor is likely to interfere with the other and result in erratic operation.

In order to avoid this, it is necessary to adhere to the minimum distances between sensors.

Maximum tightening torque

Cylindrical sensors	Diameter mm	Tightening torque	Flat sensors	Screw	Tightening torque
XX0120	Ø 12	0.7 N.m	XX0F0	M3	0.7 N.m
XX080	Ø 18	1 N.m	XX0K0	M4	1 N.m
XX000	Ø 30	1.35 N.m	XX0V0	M3	0.7 N.m
XX0V30	-	1.35 N.m		Ø 18	1 N.m

Interchangeability

Interchangeability is made easy by using indexed fixing clamps:

- XSZ B112 (Ø 12 mm),
- XSZ B118 (Ø 18 mm),
- XSZ B130 (Ø 30 mm).

Cabling

Electrical connection

- **Connect the sensor before switching on the supply**

- **Length of cable**

No limitation up to 200 m or up to a line capacitance of $< 0.1 \mu$ F,

It is, however, advisable to take into account the voltage drop on the line.

- **Separation of control and power cables**

The sensors are immune to electrical interference encountered in normal industrial conditions. Where extreme conditions of electrical "noise" could occur (large motors, spot welders, etc.), it is advisable to protect against transients in the normal way:

- suppress interference at source,
- separate power and control wiring from each other,
- smooth the supply,
- limit the length of cable.

Setting-up precautions (continued)

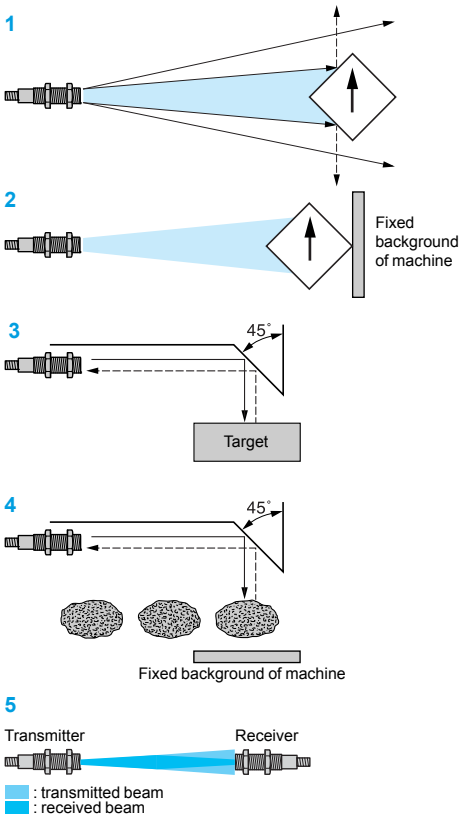
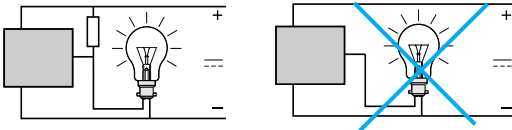
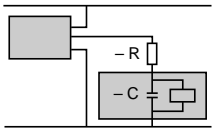
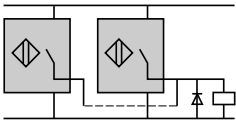
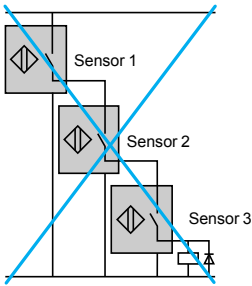

Connection in series

This connection method is not recommended.

- Correct operation of the sensors cannot be assured and, if this method is used, tests must be made before installation. The following points should be taken into account:
 - Sensor 1 carries the load current in addition to the no-load current consumption values of the other sensors connected in series. For certain models, this connection method is not possible unless a current limiting resistor is used.
 - When in the closed state, each sensor will produce a voltage drop and, therefore, the load voltage should be selected accordingly.
 - As sensor 1 closes, sensor 2 will not operate until a certain time "T" has elapsed (corresponding to the first-up delay) and likewise for the following sensors in the sequence. "Flywheel" diodes should be used when the load being switched is inductive.

Sensors and units in series with an external mechanical contact

- The following points should be taken into account:
 - When the mechanical contact is open, the sensor is not supplied.
 - When the contact closes, the sensor will not operate until a certain time "T" has elapsed (corresponding to the first-up delay).

Connection in parallel

- No specific restrictions. The use of "flywheel" diodes is recommended when an inductive load (relay) is being switched.

Capacitive load (C > 0.1 mF)

- At switch-on, it is necessary to limit (by resistor) the charging current of the capacitive load C. The voltage drop in the sensor can also be taken into account by subtracting it from the supply voltage for calculation of R.

$$R = \frac{U \text{ (supply)}}{I \text{ max. (sensor)}}$$

Load comprising an incandescent lamp

- If the load comprises an incandescent lamp, the cold state resistance can be 10 times lower than the hot state resistance. This can cause very high current levels on switching. Fit a pre-heat resistance in parallel with the sensor.

$$R = \frac{U^2}{P} \times 10, \quad U = \text{supply voltage and } P = \text{lamp power}$$

Detection

Influencing factors

- The ultrasonic sensors are particularly suited for the detection of objects that are capable of reflecting an acoustic wave and, in general, having a flat surface perpendicular to the detection axis. However, the correct operation of the ultrasonic sensor can be disrupted by:
- air currents, which can accelerate or divert the acoustic wave transmitted by the sensor (ejection of part by air jet),
 - high temperature gradients within the detection zone: an object emitting considerable heat can create zones of varying temperature that will modify the propagation time of the wave and thus prevent reliable operation,
 - sound insulators: sound absorbing materials (cotton, fabrics, rubber, etc.),
 - the angle between the face of the object to be detected and the reference axis of the sensor: when the angle is offset from 90°, the wave is no longer reflected back along the sensor axis and the operating distance is reduced. The greater the distance between the sensor and the target, the greater the effect. Detection is not possible when the angle exceeds ± 10°.
 - the shape of the object to be detected: similar to the example above, an excessively angular object can be difficult to detect 1. In this case, use reflex mode detection.

Detection systems

- Diffuse mode
 - In this mode, it is the object itself that reflects the ultrasonic wave back to the sensor which, in turn, switches its output. It is the most widely used and the most simple mode.
- Reflex or beam break mode
 - The sensor is in a permanently detecting state on a fixed background of the machine and when the object to be detected breaks the acoustic beam the output switches state 2.
 - This mode is particularly recommended in cases where the shape of the object changes (irregular, angular, non perpendicular) and also for objects that absorb sound (see above).
 - Caution: In reflex mode, the NO function opens when an object is present and the NC function closes when an object is present (see "NO output/NC output according to the detection mode" table on page 27).
 - In cases where space is restricted, a reflector 3 and 4, angled at 45°, can be used. This system can be used for both the diffuse and reflex modes. This reflector can be a flat part of the machine or a separate element.
- Thru-beam mode
 - Detection is achieved using both a transmitter and receiver, with the transmitter permanently transmitting an acoustic wave to the receiver. The breaking of the beam by the presence of an object switches the output of the receiver. This mode provides long detection distances 5.
 - In this mode there is no blind zone.**

Ultrasonic sensors

OsiSense XX, General purpose
Cylindrical, plastic or metal
DC supply, solid-state output

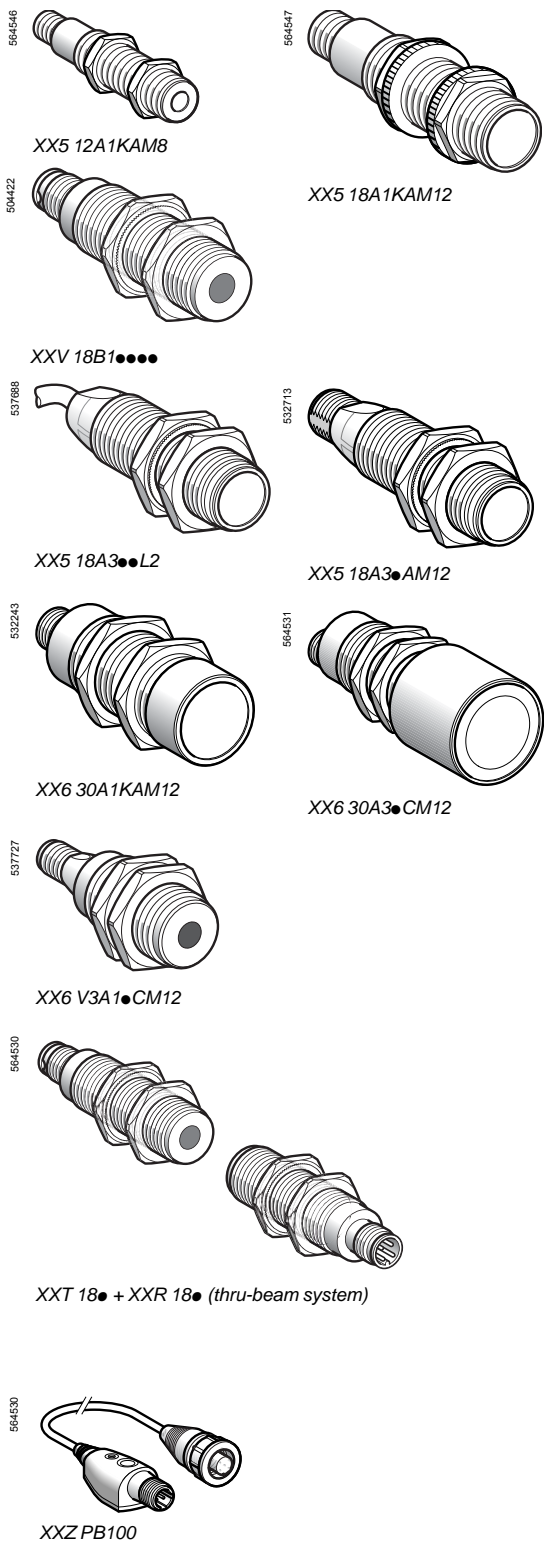

Diffuse system

Fixed sensing distance sensors

Sensors	Sensing distance (Sn) m	Function/output	Connection	Reference	Weight kg
Ø 12 Plastic	0.05	NO/PNP + NO/NPN	M8 connector	XX5 12A1KAM8	0.011
	0.10	NO/NPN	M8 connector	XX5 12A2NAM8	0.011
		NO/PNP	M8 connector	XX5 12A2PAM8	0.011
Ø 18 Plastic	0.15	NO/PNP + NO/NPN	M12 connector	XX5 18A1KAM12	0.033
Ø 18 Metal	0.05	NO/NPN	Pre-cabled (L = 2 m)	XXV 18B1NAL2	0.110
			Pre-cabled (L = 5 m)	XXV 18B1NAL5	0.200
			Pre-cabled (L = 10 m)	XXV 18B1NAL10	0.340
			M12 connector	XXV 18B1NAM12	0.050
	NO/PNP	Pre-cabled (L = 2 m)	XXV 18B1PAL2	0.110	
		Pre-cabled (L = 5 m)	XXV 18B1PAL5	0.200	
		Pre-cabled (L = 10 m)	XXV 18B1PAL10	0.340	
		M12 connector	XXV 18B1PAM12	0.050	
	NC/NPN	Pre-cabled (L = 2 m)	XXV 18B1NBL2	0.110	
		Pre-cabled (L = 5 m)	XXV 18B1NBL5	0.200	
		Pre-cabled (L = 10 m)	XXV 18B1NBL10	0.340	
		M12 connector	XXV 18B1NBM12	0.050	
NC/PNP	Pre-cabled (L = 2 m)	XXV 18B1PBL2	0.110		
	Pre-cabled (L = 5 m)	XXV 18B1PBL5	0.200		
	Pre-cabled (L = 10 m)	XXV 18B1PBL10	0.340		
	M12 connector	XXV 18B1PBM12	0.050		

Adjustable sensing distance sensors

Ø 18 Plastic	0,50 (adjustable)	NO/NPN	Pre-cabled (L = 2 m)	XX5 18A3NAL2	0.080	
		NO/PNP	Pre-cabled (L = 2 m)	XX5 18A3PAL2	0.080	
		NO/NPN	M12 connector	XX5 18A3NAM12	0.033	
		NO/PNP	M12 connector	XX5 18A3PAM12	0.033	
Ø 30 Plastic	1 (adjustable)	NO/PNP + NO/NPN	M12 connector	XX6 30A1KAM12	0.090	
		NO/NPN	M12 connector	XX6 V3A1NAM12	0.090	
		NO/PNP	M12 connector	XX6 V3A1PAM12	0.090	
		NO/NPN + NC/NPN	M12 connector	XX6 30A1NCM12	0.090	
		M12 connector	XX6 30S1NCM12 (1)	0.090		
			XX6 30A1PCM12	0.090		
		M12 connector	XX6 30S1PCM12 (1)	0.090		
			NO/NPN + NC/NPN	M12 connector	XX6 30A2NCM12	0.090
		(adjustable)	NO/PNP + NC/PNP	M12 connector	XX6 30A2PCM12	0.090
			NO/NPN + NC/NPN	M12 connector	XX6 30A3NCM12	0.110
		(adjustable)	NO/PNP + NC/PNP	M12 connector	XX6 30A3PCM12	0.110

Thru-beam system

Sensors	Sensing distance (Sn) m	Function/output	Connection	Reference	Weight kg
Ø 12					
Transmitter	0.20		M8 connector	XXT 12A8M8	0.020
Receiver	0.20	NO/PNP + NO/NPN	M8 connector	XXR 12A8KAM8	0.020
		NC/PNP + NC/NPN	M8 connector	XXR 12A8KBM8	0.020
Ø 18					
Transmitter	0.61		M12 connector	XXT 18A3M12	0.040
Receiver	0.61	NO/PNP + NO/NPN	M12 connector	XXR 18A3KAM12	0.040
		NC/PNP + NC/NPN	M12 connector	XXR 18A3KBM12	0.040
Transmitter	1		M12 connector	XXT 18A4M12	0.040
Receiver	1	NO/PNP + NO/NPN	M12 connector	XXR 18A4KAM12	0.040
		NC/PNP + NC/NPN	M12 connector	XXR 18A4KBM12	0.040

Accessories

Teach pushbutton	For use with sensors	Reference	Weight kg
Selection of detection window Input: M12 female connector Output: M12 male connector	XX5 18A3•AM12 and XX6 V3A•AM12	XXZ PB100	0.035

Other connection and fixing accessories

See page 22.

(1) Stainless steel 303 case.

Ultrasonic sensors

OsiSense XX, General purpose

Cylindrical, plastic or metal

DC supply, solid-state output

Sensor type		XX5 12A1	XX5 12A2	XX● 12A8	XXV 18B1	XX5 18A1	XX● 18A3 XX● 18A4	XX5 18A3● M12/L2	XX6 V3A1	XX6 30A1 30A2 30S1	XX6 30A3		
General characteristics													
Conformity to standards		CE, IEC 60947-5-2											
Product certifications		UL	UL	–	UL, CSA		–	UL	UL, CSA				
Nominal sensing distance (Sn)		m	0.05	0.1	0.2	0.05	0.15	0.60 or 1 (1)	0.50	1	1 or 2 (1)	8	
Blind zone (no object must pass through this zone whilst the sensor is operating)		mm	0...6.4	0...6.4	–	0...2	0...19	–	0...51	0...100	0...51 (XX6●A1) 0...120 (XX6 30A2)	0...300	
Detection window		mm	Fixed						Remotely adjustable or by using external teach button		Adjustable using teach button on sensor		
Detection system			●	●	–	●	●	–	●	●	●	●	
			–	–	●	–	–	●	–	–	–	–	
Transmission frequency (transmitter resonance)		kHz	500			360	200	300	300	180	200	75	
Differential travel		mm	< 0.7	< 0.7	–	< 3	–	< 2.5	< 2.5	< 2.5	< 2.5	< 12.7	
Repeat accuracy		mm	± 0.7		± 0.79	± 1.5	± 0.79	± 1.27	± 1.27	± 1.6	± 0.87	± 2.54	
Overall beam angle (see detection lobe)			11°	10°	10°	10°	20	6°	6°	7°	10°	16°	
Minimum size of object to be detected			Cylinder Ø (in mm), at distance (in mm)										
			Ø 2.5 at 38	Ø 2.5 at 50	Ø 12 at 200	Ø 2.5 at 20	Ø 1.6 at 63	Ø 38 at 600 Ø 114 at 1000	Ø 2.5 at 150	Ø 50 at 1000	Ø 1.6 at 635	Ø 51 at 4732	
Deviation angle from 90° of the object to be detected			± 10°	± 10°	–	± 8°	± 10°	–	± 7°	± 5°	± 7° or ± 10° (1)	± 5°	
Materials			Case			Sensing face							
			ULTEM®			Nickel plated brass	ULTEM®	ULTEM®	Valox®	Valox®	ULTEM®	ULTEM®	
			Stainless steel 303 for XX6 30AS1●●●●										
			Epoxy			Epoxy	Silicone	Silicone	Epoxy	Epoxy	Silicone	Epoxy	
Connection			Connector		Pre-cabled (wire c.s.a.)								
			M8, 4-pin	M8, 3-pin	M8, 4-pin	M12, 4-pin	M12, 4-pin	M12, 4-pin	M12, 4-pin	M12, 4-pin	M12, 4-pin	M12, 4-pin	
			–	–	–	3 x 0.34 mm ²	–	–	4 x 0.08 mm ²	–	–	–	
Supply characteristics													
Rated supply voltage		V	12...24 V --- with protection against reverse polarity										
Voltage limits (including ripple)		V	10...28 V ---			10... 36 V ---	10...28 V ---						
Current consumption, no-load		mA	25	50	15	60	40	40	60	50, 100 (1)	50		
Output characteristics													
LED indicators			Output state			Power on			Setting-up assistance				
			Yellow LED			–	–	–	Yellow LED				
			Green LED			–	–	–	Green LED				
			–	–	–	–	–	–	Multicolour LED				
Switching capacity (with overload and short-circuit protection)		mA	< 100			< 200	< 100						
Voltage drop		V	< 1 (NPN); < 1.5 (PNP); 1.1 for XX●12A8, < 2 for XXV 18B1●, 0.5 for (XX6 30A2)										
Maximum switching frequency		Hz	125	125	125	80	80	40	40	70	10 or 16 (1)	2	
Delays			First-up			Response			Recovery				
		ms	20	20	20	5	350	100	100	75	720	800	
		ms	2	3	0.4	4	3	10	10	15	20 or 25 (1)	200	
		ms	2	3	0.4	4	3	10	10	75	20	200	
Environmental characteristics													
Degree of protection			Conforming to IEC 60529 and IEC 60947-5-2			IP 67	IP 65 IP 67 (2)	IP 67	IP 67	IP 67	IP 67	IP 65 or IP 67 (1)	IP 67
Storage temperature		°C	- 40...+ 80										
Operating temperature		°C	- 20...+ 65			0 ...+ 60	0 ...+ 50	0...+ 60	- 20 ...+ 65	0...+ 70	0...+ 60 or 0...+ 50 (1)	- 20...+ 60	
Vibration resistance			Conforming to IEC 60068-2-6										
			Amplitude ± 1 mm (f = 10...55 Hz); ± 2 mm for XXV 18B1										
Mechanical shock resistance			Conforming to IEC 60068-2-27										
			30 gn, duration 11 ms, in all 3 axes 50 gn, duration 11 ms, in all 3 axes for XXV 18B1										
Resistance to electromagnetic interference			Conforming to IEC 60947-5-2										

(1) Depending on model. (2) Double insulation for sensors with cable.

Ultrasonic sensors

OsiSense XX, General purpose

Flat format, plastic

DC supply, solid-state output

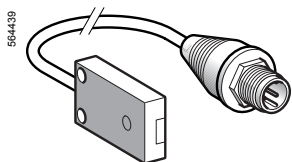

564439
XX7 F1A2●AL01M12

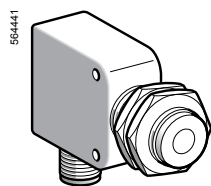

564441
XX7 V1A1●AM12

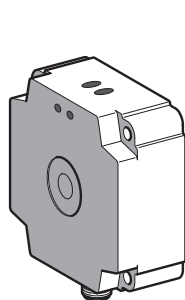

DJE53726
XX8 D1A1●AM12

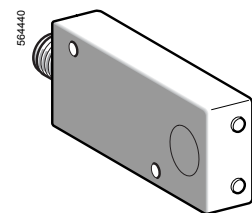

564440
XX7 K1A2●AM12

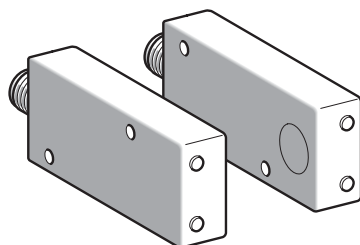

XX7 K1A2●AM12 + XX7 K1A2●AM12 (thru-beam system)



564530
XXZ PB100

Diffuse system

Fixed sensing distance sensors

Sensors	Sensing distance (Sn)	Function/output	Reference	Weight
mm	m			kg
7.6 x 19 x 33	0.10	NO/NPN	XX7 F1A2NAL01M12	0.040
		NO/PNP	XX7 F1A2PAL01M12	0.040
16 x 30 x 74	0.25	NO/NPN	XX7 K1A2NAM12	0.050
		NO/PNP	XX7 K1A2PAM12	0.050

Adjustable sensing distance sensors

Sensors	Sensing distance (Sn)	Function/output	Reference	Weight
mm	m			kg
18 x 33 x 60 + Ø 18	0.50 (adjustable)	NO/NPN	XX7 V1A1NAM12	0.060
		NO/PNP	XX7 V1A1PAM12	0.060
80 x 80 x 34	1 (adjustable)	NO/NPN	XX8 D1A1NAM12	0.300
		NO/PNP	XX8 D1A1PAM12	0.300

Thru-beam system

Sensors	Sensing distance (Sn)	Function/output	Connection	Reference	Weight
mm	m				kg
7.6 x 19 x 33					
Transmitter	0.20		152 mm flying lead + M12 connector	XXT F1A8M12L	0.030
Receiver	0.20	NO/PNP + NO/NPN	152 mm flying lead + M12 connector	XXR F1A8KAM12L	0.030
		NC/PNP + NC/NPN	152 mm flying lead + M12 connector	XXR F1A8KBM12L	0.030
16 x 30 x 74					
Transmitter	0.61		M12 connector	XXT K1A3M12	0.060
Receiver	0.61	NO/PNP + NO/NPN	M12 connector	XXR K1A3KAM12	0.060
		NC/PNP + NC/NPN	M12 connector	XXR K1A3KBM12	0.060
Transmitter	1		M12 connector	XXT K1A4M12	0.060
Receiver	1	NO/PNP + NO/NPN	M12 connector	XXR K1A4KAM12	0.060
		NC/PNP + NC/NPN	M12 connector	XXR K1A4KBM12	0.060

Accessories

Description	For use with sensor	Reference	Weight
			kg
Teach pushbutton	XX7 V1A1●AM12 and XX8 D1A1●AM12	XXZ PB100	0.035
Selection of detection window			
Length of cable: 152 mm			
Input:			
M12 female connector			
Output:			
M12 male connector			

Other connection and fixing accessories

See page 22.

Ultrasonic sensors

OsiSense XX, General purpose

Flat format, plastic

DC supply, solid-state output

Sensor type		XX7 F●	XXT F● XXR F●	XX7 K●	XXT K● XXR K●	XX7 V●	XX8 D●
General characteristics							
Conformity to standards		CE, IEC 60947-5-2					
Product certifications		UL, CSA	–	CSA	–	CSA	UL, CSA
Nominal sensing distance (Sn)	m	0.1	0.2	0.25	0.6 (XX● K1A3) 1 (XX● K1A4)	0.5	1
Blind zone (no object must pass through this zone whilst the sensor is operating)	mm	0...6.4	–	0...51	–	0...51	0...100
Detection window		Fixed	Fixed	Fixed	Fixed	Remotely adjustable or by using teach button	
Detection system	Diffuse	●	–	●	–	●	●
	Thru-beam	–	●	–	●	–	–
Transmission frequency	kHz	500	500	500	200	300	180
Differential travel	mm	< 0.7	–	< 0.35	–	< 2.5	< 2.5
Repeat accuracy	mm	± 0.7	± 0.79	± 0.7	± 0.79	± 1.27	± 1.6
Overall beam angle (see detection lobe)		14°	10°	14°	20°	12°	7°
Minimum size of object to be detected		Cylinder Ø 2.5 mm or flat bar 1 mm wide up to a sensing distance of 50 mm	Cylinder Ø 12.2 mm up to a sensing distance of 200 mm	Cylinder Ø 1.6 mm up to a sensing distance of 76 mm	XX● K1A3: Cylinder Ø 38 mm up to a sensing distance of 600 mm XX● K1A4: Cylinder Ø 114 mm up to a sensing distance of 1 m	Cylinder Ø 2.5 mm or flat bar 1 mm wide up to a sensing distance of 150 mm	Cylinder Ø 50 mm up to a sensing distance of 1 m
Materials	Case	ULTEM®	ULTEM®	ULTEM®	ULTEM®	Valox®	Valox®
	Sensing face	Epoxy	Epoxy	Silicone	Silicone	Epoxy	Epoxy
Connection	Connector	M12, 4-pin, on 152 mm flying lead	M12, 4-pin, on 152 mm flying lead	M12, 4-pin	M12, 4-pin	M12, 4-pin	M12, 4-pin
Supply characteristics							
Rated supply voltage	V	12...24 V $\overline{\text{---}}$ with protection against reverse polarity					
Voltage limits (including ripple)	V	10...28 V $\overline{\text{---}}$					
Current consumption, no-load	mA	25	50	60	XX● K1A3: 60 XX● K1A4: 100	40	70
Output characteristics							
LED indicators	Output state	Yellow LED					
	Power on	Green LED				–	Green LED
	Setting-up assistance	–	–	–	–	Multicolour LED	
Switching capacity	(PNP and NPN)	mA < 100, NO or NC function					
							100
Voltage drop	(PNP and NPN)	V < 1	< 1.1	< 1	< 1	< 1	< 1
Maximum switching frequency		Hz 100	125	80	125	40	72
Delays	First-up	ms 20	20	350	200	100	75
	Response	ms 4	4	5	5	10	15
	Recovery	ms 4	4	5	5	10	75
Environmental characteristics							
Degree of protection	Conforming to IEC 60529 and IEC 60947-5-2	IP 67					
Storage temperature	°C	- 40...+ 80					
Operating temperature	°C	- 20...+ 65	0...+ 50	- 20...+ 65	- 20...+ 65	0...+ 70	
Vibration resistance	Conforming to IEC 60068-2-6	Amplitude ± 1 mm (f = 10...55 Hz)					
Mechanical shock resistance	Conforming to IEC 60068-2-27	30 gn, duration 11 ms, in all 3 axes					
Resistance to electromagnetic interference		Conforming to IEC 60947-5-2					

Ultrasonic sensors

OsiSense XX, Application

Plastic case, cylindrical type and flat format

Sensors with analogue output signal 0... 10 V
or 4-20 mA

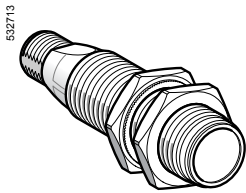

XX9 18A3●●M12

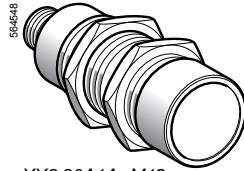

XX9 30A1A●●M12

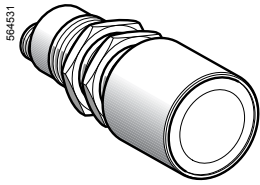

XX9 30A3A●●M12

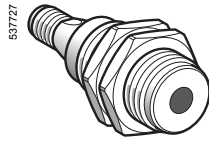

XX9 V3A1●●M12

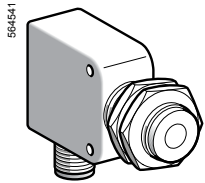

XX9 V1A1●●M12

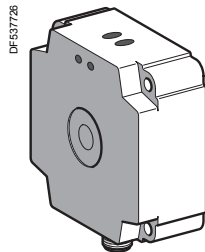

XX9 D1A1●●M12

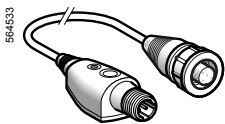

XXZ PB100

Cylindrical sensors

Sensors	Sensing distance (Sn) m (adjustable)	Analogue output (Slope selection using teach button)	Reference	Weight kg	
Standard analogue output					
Ø 18	0.5	4-20 mA	XX9 18A3C2M12	0.033	
		0-10 V	XX9 18A3F1M12	0.033	
Ø 30	1	4-20 mA	XX9 30A1A2M12	0.095	
		0-10 V	XX9 30S1A2M12 (1)	0.095	
		4-20 mA	XX9 30A1A1M12	0.095	
		0-10 V	XX9 30S1A1M12 (1)	0.095	
	2	8	4-20 mA	XX9 V3A1C2M12	0.090
			0-10 V	XX9 V3A1F1M12	0.090
			4-20 mA	XX9 30A2A2M12	0.095
			0-10 V	XX9 30A2A1M12	0.095
8	8	4-20 mA	XX9 30A3A2M12	0.115	
		0-10 V	XX9 30A3A1M12	0.115	

250 ms delayed analogue output (for unstable object)

Ø 30	1	4-20 mA	XX9 30A1A2230M12	0.095
		0-10 V	XX9 30A1A1230M12	0.095
	2	4-20 mA	XX9 30A2A230M12	0.095
		0-10 V	XX9 30A2A1230M12	0.095

(1) Stainless steel 303 case.

Flat format sensors

Sensors	Sensing distance (Sn) m (adjustable)	Analogue output (Slope selection using teach button)	Reference	Weight kg
18 x 33 x 65 + Ø 18	0.5	4-20 mA	XX9 V1A1C2M12	0.090
		0-10 V	XX9 V1A1F1M12	0.060
80 x 80 x 34	1	4-20 mA	XX9 D1A1C2M12	0.300
		0-10 V	XX9 D1A1F1M12	0.300

Accessories

Teach pushbutton

Teach pushbutton	For use with sensors	Reference	Weight kg
Selection of detection window Length of cable: 152 mm Input: M12 female connector Output: M12 male connector	XX9 18A●, XX9 V3A●, XX9 D1A●	XXZ PB100	0.035

Other connection and fixing accessories

See page 22.

Sensor type		XX9 18A3●	XX9 V1A1●	XX9 30A1● XX9 30A2●	XX9 30A3●	XX9 V3A1●	XX9 D1A1●	
General characteristics								
Conformity to standards		CE, IEC 60947-5-2						
Product certifications		UL, CSA						
Nominal sensing distance (Sn)	m	0.5	0.5	1 or 2 (1)	8	1	1	
Blind zone (no object must pass through this zone whilst the sensor is operating)	mm	0...51		0...51 or 0...120 (1)	0...203	0...100	0...100	
Detection window	mm	Remotely adjustable or by using external teach button		Adjustable using teach button on sensor		Remotely adjustable or by using external teach button		
Transmission frequency	kHz	300		200	75	180	180	
Repeat accuracy	mm	1.27		± 0.9	± 2.54	± 0.9	± 1.6	
Overall beam angle (see detection lobe)		6°		10°	16°	7°	7°	
Minimum size of object to be detected		Cylinder Ø 2.5 mm or flat bar 1 mm wide for a sensing distance of 150 mm		Cylinder Ø 1.6 mm up to a sensing distance of 635 mm	Cylinder Ø 50.68 mm up to a sensing distance of 4732 mm	Cylinder Ø 50 mm up to a sensing distance of 1 m	Cylinder Ø 50 mm up to a sensing distance of 1 m	
Deviation angle from 90° of the object to be detected		± 7°		± 8°	± 5°	± 5°	± 5°	
Materials	Case	Valox®		ULTEM®	ULTEM®	Valox®	Valox®	
	Sensing face	Epoxy		Silicone	Epoxy			
Connection	Connector	M12, 4-pin						
Supply characteristics								
Rated supply voltage (with protection against reverse polarity)	V	12...24 V $\overline{\text{DC}}$		15...24 V $\overline{\text{DC}}$	15...24 V $\overline{\text{DC}}$	15...24 V $\overline{\text{DC}}$	15...24 V $\overline{\text{DC}}$	
Voltage limits (including ripple)	V	10...28 V $\overline{\text{DC}}$						
Current consumption, no-load	mA	40	40	60, 80 (1)	60	60	70	
Output characteristics								
Slope type		Direct or inverse by using teach button, see page 29.						
LED indicators	Output state	Yellow LED						
	Power on	Green LED						
	Setting-up assistance	Dual colour LED						
Delays	First-up	ms	100	100	720	1200	75	75
Recovery time		ms	150	150	250 (delayed) 50 (standard)	250	180	180
Resistive load impedance	4-20 mA	Ω	10...500			10...500	10...350	10...350
	0-10 V	Ω	1 k...∞			1 k...∞	1 k...∞	2 k fixed
Environmental characteristics								
Degree of protection	Conforming to IEC 60529 and IEC 60947-5-2		IP 67		IP 67	IP 65	IP 67	IP 67
Storage temperature		°C	- 40...+ 80					
Operating temperature		°C	- 20...+ 65		0...+ 50	- 20...+ 60	0...+ 70	0...+ 70
Vibration resistance	Conforming to IEC 60068-2-6		Amplitude ± 1 mm (f = 10...55 Hz)					
Mechanical shock resistance	Conforming to IEC 60068-2-27		30 gn, duration 11 ms, in all 3 axes					
Resistance to electromagnetic interference			Conforming to IEC 60947-5-2					

(1) Depending on model.

Ultrasonic sensors

OsiSense XX, Application

Sensors for monitoring 2 levels

Cylindrical plastic case, M18 x 1 and M30 x 1.5

DC supply, solid-state output

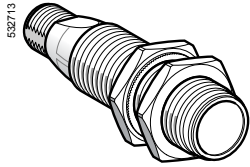

XX2 18A3●●M12

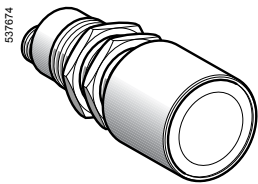

XX2 30A●1/●2●●●00M12

Sensors for monitoring levels

Sensors	Sensing distance (Sn)	Function/output	Reference	Weight
	m			kg
Ø 18, threaded M18 x 1				
2 emptying levels	0.5 (adjustable)	NO/NPN	XX2 18A3NHM12	0.035
		NO/PNP	XX2 18A3PHM12	0.035
2 filling levels	0.5 (adjustable)	NO/NPN	XX2 18A3NFM12	0.035
		NO/PNP	XX2 18A3PFM12	0.035
Ø 30, threaded M30 x 1.5				
2 levels independent outputs	1 (adjustable)	NO/NPN + NO/NPN	XX2 30A12NA00M12	0.090
		NO/PNP + NO/PNP	XX2 30A12PA00M12	0.090
	2 (adjustable)	NO/NPN + NO/NPN	XX2 30A22NA00M12	0.090
		NO/PNP + NO/PNP	XX2 30A22PA00M12	0.090
2 emptying levels	1 (adjustable)	NO/PNP + NO/PNP	XX2 30A10PA00M12	0.090
		NO/PNP + NO/PNP	XX2 30A20PA00M12	0.090
2 filling levels	1 (adjustable)	NO/PNP + NO/PNP	XX2 30A11PA00M12	0.090
		NO/PNP + NO/PNP	XX2 30A21PA00M12	0.090

Accessories

Teach pushbutton

Teach pushbutton	For use with sensors	Reference	Weight
Selection of detection window	XX2 18A3●	XXZ PB100	0.035
Length of cable: 152 mm			
Input: M12 female connector			
Output: M12 male connector			

Other connection and fixing accessories

See page 22.

Ultrasonic sensors

OsiSense XX, Application

Sensors for monitoring 2 levels

Cylindrical plastic case, M18 x 1 and M30 x 1.5

DC supply, solid-state output

Sensor type		XX2 18A3●●●●	XX2 30A1●●●●	XX2 30A2●●●●
General characteristics				
Conformity to standards		CE, IEC 60947-5-2		
Product certifications		UL	UL, CSA	UL, CSA
Nominal sensing distance (Sn)		m 0.50 (adjustable)	1 (adjustable)	2 (adjustable)
Blind zone (no object must pass through this zone whilst the sensor is operating)		mm 0...51	0...51	0...120
Detection window		Remotely adjustable or by using external teach button	Adjustable using teach button on sensor	
Transmission frequency		kHz 300	200	
Differential travel		mm < 2.5	< 2.5	< 2.5
Repeat accuracy		mm ± 1.27	± 0.9	
Overall beam angle (see detection lobe)		6°	10°	10°
Minimum size of object to be detected		Cylinder Ø 2.5 mm up to a sensing distance of 150 mm	Cylinder Ø 1.6 mm up to a sensing distance of 305 mm	
Deviation angle from 90° of the object to be detected		± 7°	± 10° on 305 x 305 mm	
Materials				
	Case	Valox®	ULTEM®	
	Sensing face	Epoxy	Silicone	
Connection		Connector	M12, 4-pin	
Supply characteristics				
Rated supply voltage		V 12...24 V $\overline{\text{---}}$ with protection against reverse polarity		
Voltage limits (including ripple)		V 10...28 V $\overline{\text{---}}$		
Current consumption, no-load		mA 40	100	
Output characteristics				
LED indicators		Output state	Yellow LED	Multicolour LED
	Power on		Green LED	–
	Setting-up assistance		Dual colour LED	Multicolour LED
	Distance indication		–	Yellow LED
Switching capacity		mA < 100 (PNP and NPN) with overload and short-circuit protection		
Voltage drop		V < 1 (PNP and NPN)		
Delays				
	First-up	ms 100	1000	1000
	Response	ms 15	150	150
	Recovery	ms 1000	1000	1000
Environmental characteristics				
Degree of protection		Conforming to IEC 60529 and IEC 60947-5-2	IP 67	IP 65
Storage temperature		°C - 40...+ 80	- 10...+ 80	
Operating temperature		°C - 20...+ 65	0...+ 50	
Vibration resistance		Conforming to IEC 60068-2-6	Amplitude ± 1 mm (f = 10...55 Hz)	
Mechanical shock resistance		Conforming to IEC 60068-2-27	30 gn, duration 11 ms, in all 3 axes	
Resistance to electromagnetic interference			Conforming to IEC 60947-5-2	

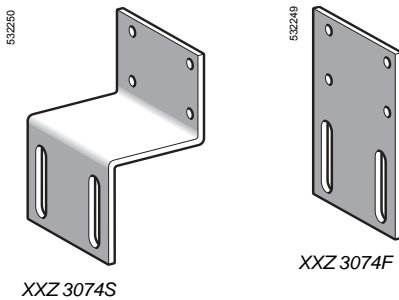
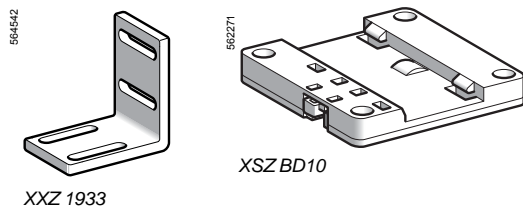
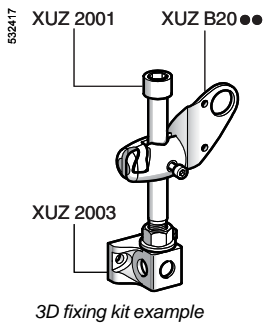
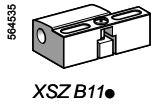
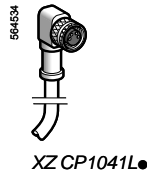
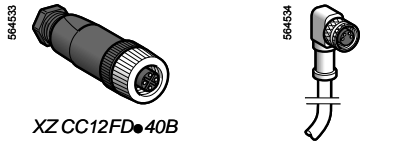

References of accessories

Cabling accessories

Connectors	For use with sensor	Type of connection	Reference	Weight kg	
M8 3-pin	Ø 12	IDC (Insulation Displacement Connector)	Straight	XZ CC8FDM30V	0.010
	XX512A2		Elbowed	XZ CC8MDM30V	0.010
M8 4-pin	XX512A1		Straight	XZ CC8FDM40V	0.010
	XX12A8		Elbowed	XZ CC8MDM40V	0.010
M12	Ø 18, Ø 30	Screw terminals, metal clamping ring	Straight	XZ CC12FDM40B	0.020
			Elbowed	XZ CC12FCM40B	0.020
		Screw terminals, plastic clamping ring	Straight	XZ CC12FDP40B	0.020
			Elbowed	XZ CC12FCP40B	0.020

Pre-wired connectors

Pre-wired connectors	For use with sensor	Type	Cable length m	Reference	Weight kg
M8 3-pin	Ø 12	Straight	2	XZ CP0166L2 (1)	0.080
	XX5 12A2	Elbowed	2	XZ CP0266L2 (1)	0.080
M12	Ø 18, Ø 30	Straight	2	XZ CP1141L2 (1)	0.090
		Elbowed	2	XZ CP1241L2 (1)	0.090

Fixing accessories

Description	For use with sensor	Reference	Weight kg	
Fixing clamps	Ø 12	XSZ B112	0.006	
	Ø 18	XSZ B118	0.010	
Fixing clamps (mounting on 35 mm rail)	XXD	XSZ BD10	0.065	
90° fixing bracket	Ø 12	XXZ 12	0.025	
	Ø 18	XUZ A118	0.038	
	Ø 30	XXZ 30	0.115	
	XX7 F	XXZ 1933	0.025	
Flat mounting plate	XX7 K	XXZ 3074F	0.025	
Cranked mounting plate	XX7 K	XXZ3074S	0.075	
3D fixing kit (2)	M12 rod	Ø 12, Ø 18 and Ø 30	XUZ 2001	0.050
	Support for M12 rod	Ø 12, Ø 18 and Ø 30	XUZ 2003	0.160
	Ball-joint mounted fixing bracket	Ø 12	XUZ B2012	0.175
		Ø 18	XUZ B2003	0.175
	Ø 30	XUZ B2030	0.160	

(1) For a 5 m long cable replace L2 by L5; for a 10 m long cable replace L2 by L10.

(2) To obtain a 3D fixing kit, order:

rod support XUZ 2003, M12 rod XUZ 2001 and ball-joint mounted fixing bracket XUZ B20

Dimensions

Fixing accessories

XUZ A118

90° fixing bracket (Ø 18)

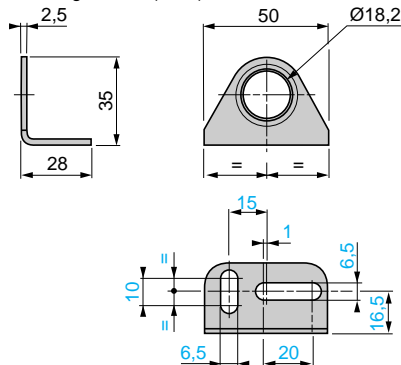

XXZ 12, XXZ 30

90° fixing bracket (Ø 12 and Ø 30)

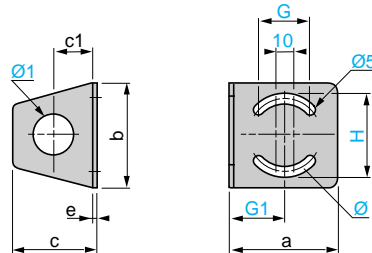

XXZ	a	b	c	c1	e	H	G	G1	Ø	Ø1
12	35	40	33	18	2	31	18	18	25	13
30	67	65	52	25	3	51	35	33	50	31

Dimensions (continued)

Fixing accessories (continued)

XSZ B112, XSZ B118

Fixing clamps (Ø 12 and Ø 18)

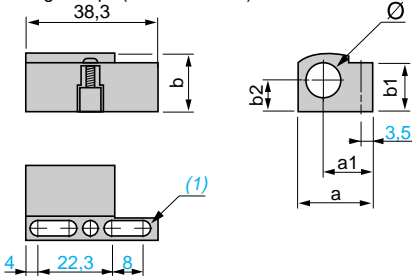

XSZ	a	a1	b	b1	b2	Ø
B112	21.9	14.5	16	15.5	8.5	12
B118	26	15.7	22.3	20.1	11.5	18

(1) 2 elongated holes Ø 4 x 8.

XXZ 1933

90° fixing bracket (XX●F●)

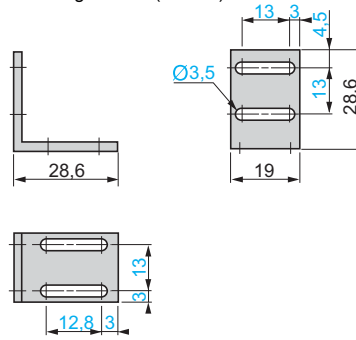

XXZ 3074S

Cranked mounting plate (XX●K●)

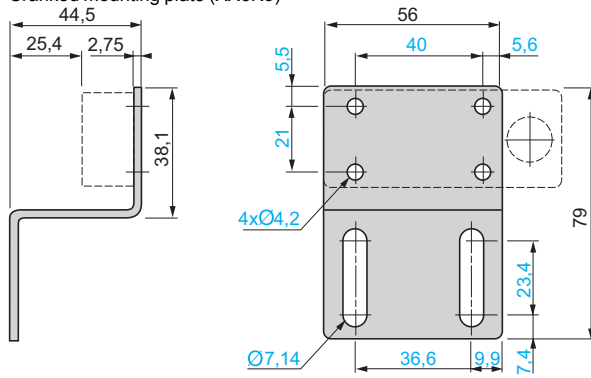
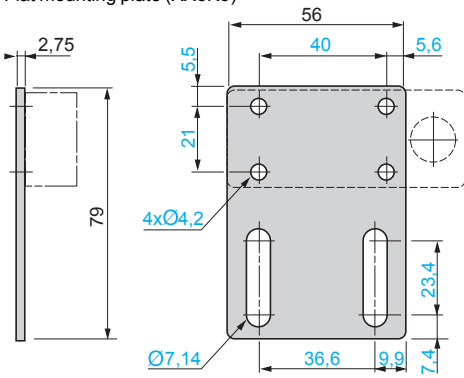

XUZ 2001

M12 rod

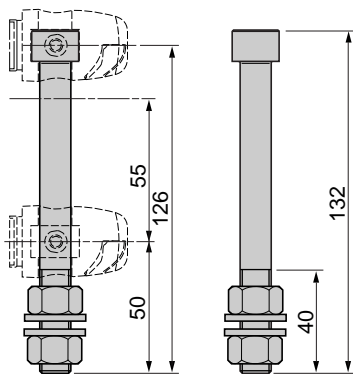

XUZ 2003

Support for M12 rod

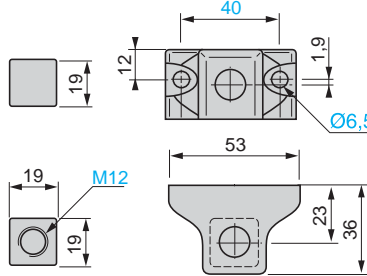

XSZ BD10

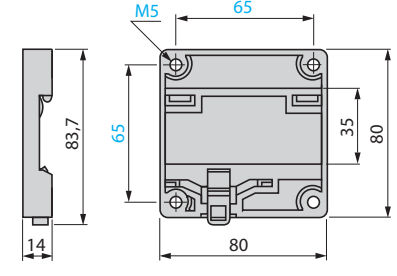

XUZ B2012

Ball-joint mounted fixing bracket (Ø 12)

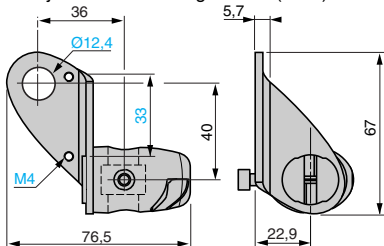

XUZ B2003

Ball-joint mounted fixing bracket (Ø 18)

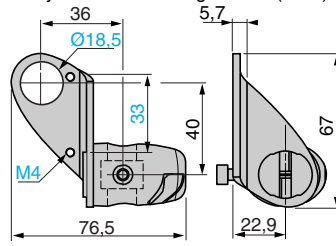

XUZ 2030

Ball-joint mounted fixing bracket (Ø 30)

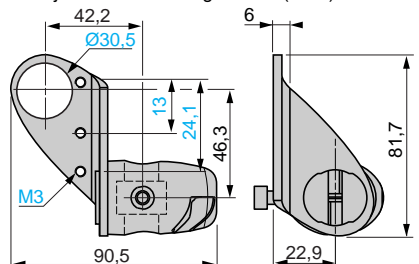

Dimensions

XX●12A●●●M8

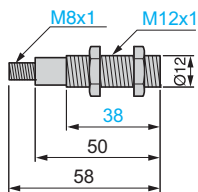

XX5 18A1KAM12
XXT 18A●M12
XXR 18A●●●●

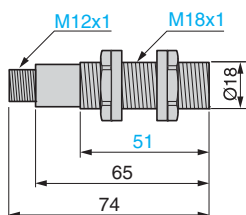

XX5 18A3●●L2

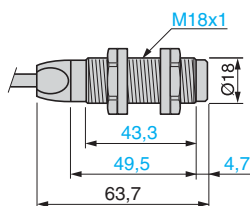

XX5 18A3●AM12
XX9 18A3●AM12
XX2 18A3●●M12

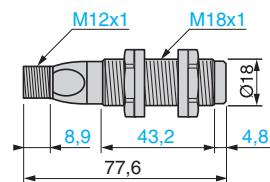

XXV 18B1●●●M12

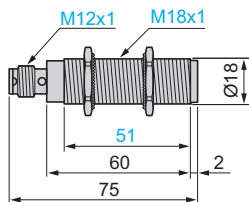

XXV 18B1●●●L●

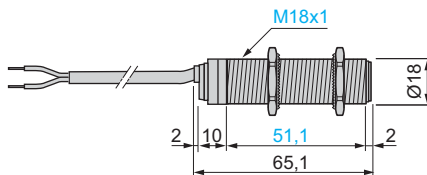

XX6 30A1●●M12
XX6 30S1●●M12
XX6 30A2●●M12
XX9 30A1A●M12
XX2 30A1●●A00M12
XX2 30A2●●A00M12

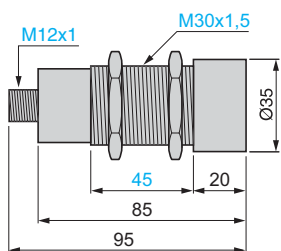

XX6 V3A1●AM12
XX9 V3A1●●M12

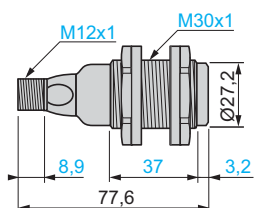

XX6 30A3●●M12
XX9 30A3A●M12

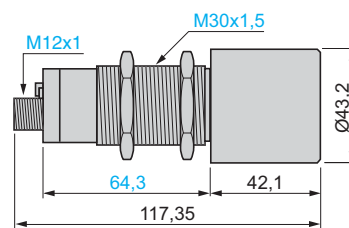

Dimensions

XX7 F1A2●AL01M12
XXT F1A8● / XXR F1A8●

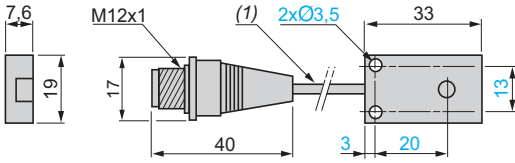

XX7 K1A2●AM12
XXT K1A3●/A4●, XXR K1A3●/A4●

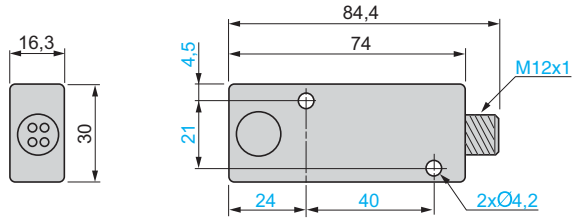

(1) Cable, length: 152 mm.

XX7 V1A1●AM12

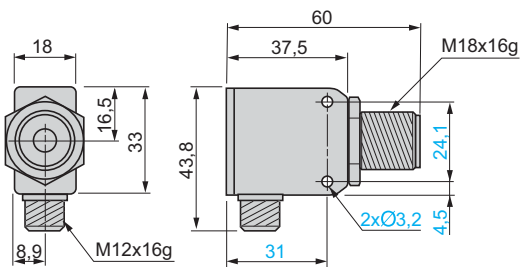

XX9 V1A1●M12

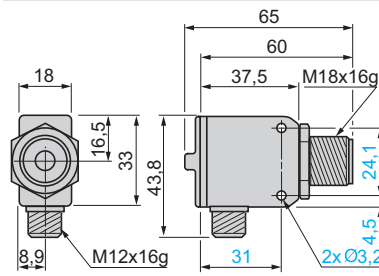

XX8 D1A1●AM12
XX9 D1A1●AM12

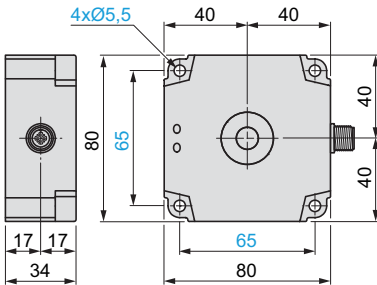

XXZ PB100

Teach pushbutton

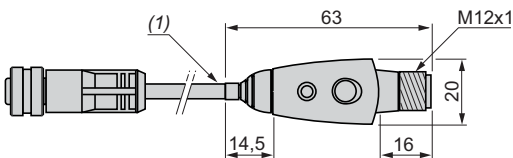

(1) Cable, length: 152 mm.

Wiring schemes

Digital output , Ø 12, M8 connector

XX5 12A1KAM8

4-wire type

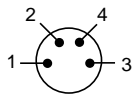

1 (+)
3 (-)
2 PNP output
4 NPN output

NO outputs, PNP and NPN

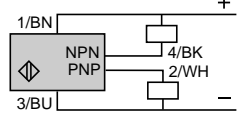

(-) BU (Blue) (+) BN (Brown)
WH (White) BK (Black)

XX5 12A2●

3-wire type

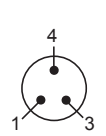

1 (+)
3 (-)
4 NPN or PNP output

NO outputs, NPN

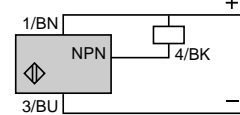

(-) BU (Blue) (+) BN (Brown)
BK (Black)

NO outputs, PNP

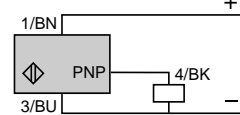

Digital output , Ø 18, M12 connector

XX5 18A1KAM12

4-wire type

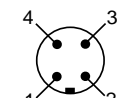

1 (+)
3 (-)
2 PNP output
4 NPN output

NO outputs, PNP and NPN

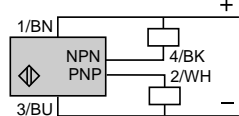

(-) BU (Blue) (+) BN (Brown)
WH (White) BK (Black)

XX5 18A3●, XX6 V3●, XX2 18A3●, XX7 V1●, XX8 D1●

3-wire type

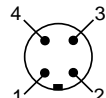

1 (+)
3 (-)
2 Teach input (WH)
4 NPN or PNP output

NO outputs, NPN

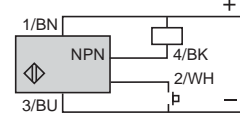

(-) BU (Blue) (+) BN (Brown)
BK (Black)

NO outputs, PNP

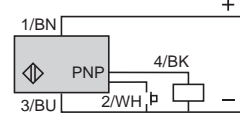

XXV 18B1●●●M12

3-wire type

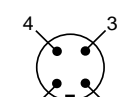

1 (+)
3 (-)

NO outputs, NPN

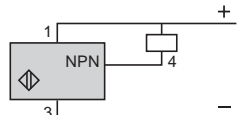

NO outputs, PNP

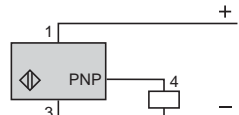

NC outputs, NPN

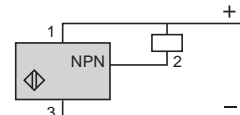

NC outputs, PNP

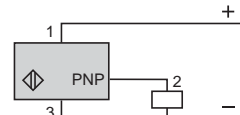

Digital output , Ø 18, pre-cabled

XXV 18B1●●●L●

3-wire type

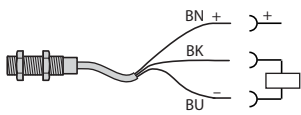

(-) BU (Blue) (+) BN (Brown) BK (Black)

XX5 18A3●●●L2

PNP output

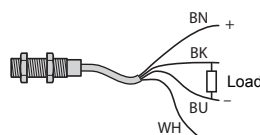

NPN output

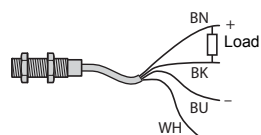

Digital output , Ø 30, M12 connector

XX6 30A1KAM12

4-wire type

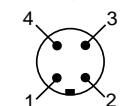

1 (+)
3 (-)
2 PNP output
4 NPN output

NO outputs, PNP and NPN

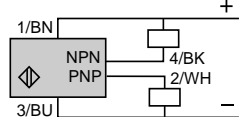

(-) BU (Blue) (+) BN (Brown)
WH (White) BK (Black)

XX6 30A●●●M12

NO + NC outputs, NPN

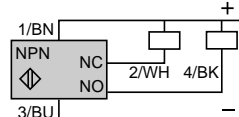

(-) BU (Blue) (+) BN (Brown)
WH (White) BK (Black)

NO + NC outputs, PNP

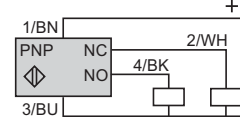

Window adjustment

Window adjustment

Thru-beam sensors: XXT 12●/XXR12●, XXT 18●/XXR 18●, XXT F1●/XXR F1●, XXT K1●/XXR K1●

Transmitter

XXT 12A8M8, XXT18A3 M12, XXT F1A8 M12L, XXT K1A●M12

M8

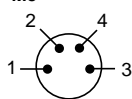

1 (+)
3 (-)

M12

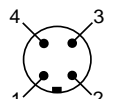

1 (+)
3 (-)

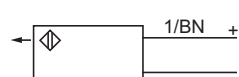

Receiver

XXR 12A8K●M8, XXR F1A8●K●M12L, XXR K1A●K●M12

M8

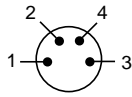

1 (+)
2 (PNP)
3 (-)
4 (NPN)

M12

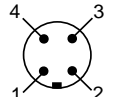

1 (+)
2 (PNP)
3 (-)
4 (NPN)

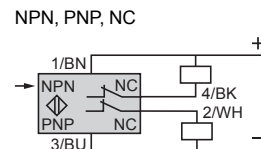
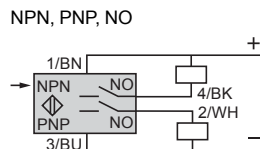

Note: See "NO output/ NC output according to the detection mode" table on page 27.

Wiring schemes (continued)

M12 connector, digital output

3-wire type

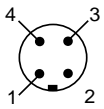

- 1 (+)
- 3 (-)
- 4 NPN or PNP output

XX7 F1A2NAL01M12 (1), XX7 K1A2NAM12

NO outputs, NPN

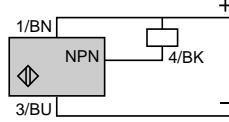

XX7 F1A2PAL01M12 (1), XX7 K1A2PAM12,

NO outputs, PNP

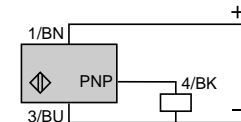

- (-) BU (Blue)
- (+) BN (Brown)
- BK (Black)

(1) Remote connector on flying lead approximately 15 cm long.

M12 connector, analogue output

XX9 30A●/XX9 30S●

4-wire type

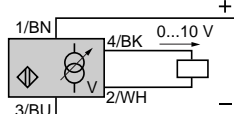
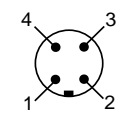

- 1 (+)
- 2 Return signal or teach
- 3 (-)
- 4 Output signal

- BN (Brown)
- WH (White)
- BU (Blue)
- BK (Black)

XX9 18A●/XX9 V1A●/XX9 V3A●/XX9 D1●

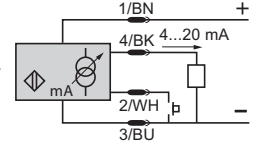
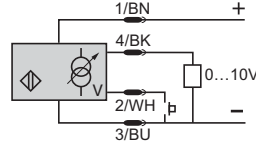

For impedance of resistive load refer to values on page 19.

XX2 30A●0●/XX2 30A●1●

NO + NO outputs, PNP

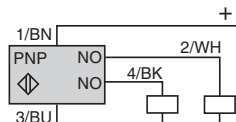
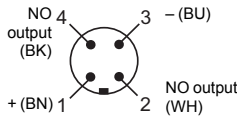

XX2 30A●2●

NO + NO outputs, NPN

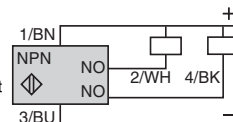
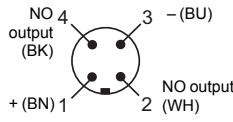

NO + NO outputs, PNP

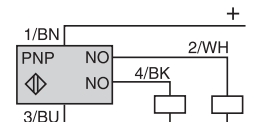

- BN (Brown)
- WH (White)
- BU (Blue)
- BK (Black)

Wiring for teaching of detection window

Using external contact

XX●18A3●/XX●V3●/XX●D1●

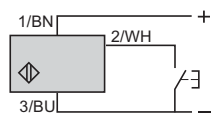

Using XXZ PB100

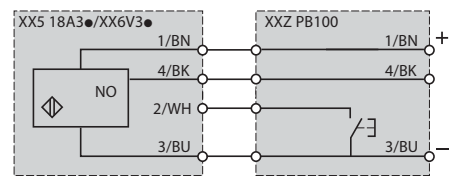
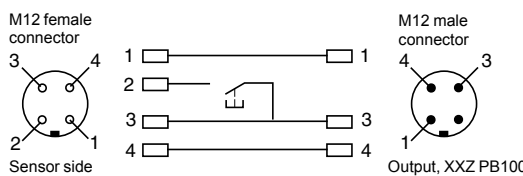

Note: Terminal 2 must be disconnected during product use.

- 1 (+) BN (Brown)
- 2 WH (White)
- 3 (-) BU (Blue)
- 4 BK (Black)

NO output/NC output according to the detection mode

	NO output	NC output
--	-----------	-----------

No object present

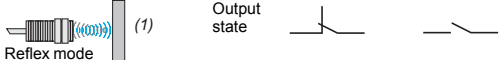

Object present



(1) Fixed background of machine

Setting-up

Minimum mounting distances

Diffuse sensors, cylindrical type

Side by side

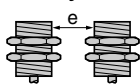

Face to face

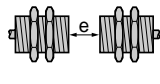

e: respect the distances indicated on the detection curves

$e \geq 4 \times S_n \text{ max.}$

Diffuse sensors, flat format

Side by side

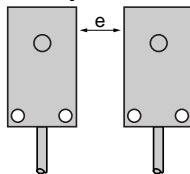

e: respect the distances indicated on the detection curves

XX V18●

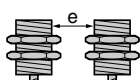

$e > 25 \text{ mm}$

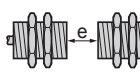

$e > 700 \text{ mm}$

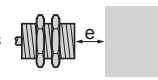

$e > 60 \text{ mm}$

Thru-beam sensors

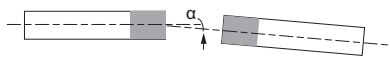

Sensors	α
XX●12●●/XX●F1●●	$\pm 5^\circ$
XX●18A3●●/XX●K1A3●●●	$\pm 8^\circ$
XX●18A4●●/ XX●K1A4	$\pm 10^\circ$
XX●18A2●●/ XX●K1A2	

XX5 12A1KAM8

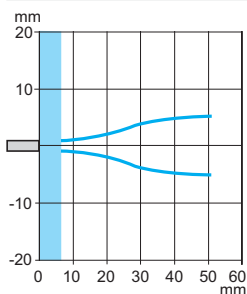

XX5 12A2●NAM8

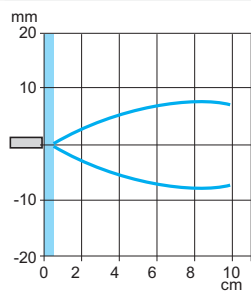

XX5 18A1KAM12

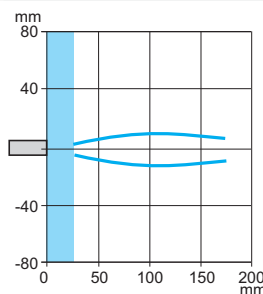

XX2 18A3 XX5 18A3●●L2 XX5 18A3●AM12 XX7 V1A1●AM12 XX9 18A3●●M12, XX9 V3A1●●M12

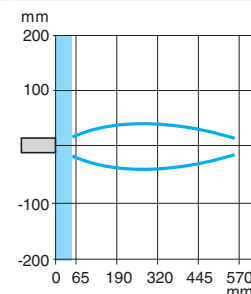

XXV 18B1●

Square object

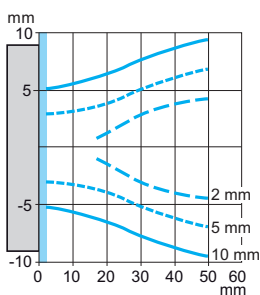

Cylindrical object

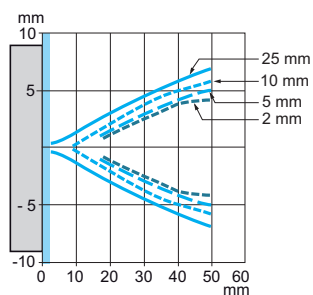

XX6 30A2●CM12

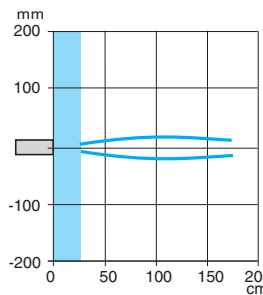

XX6 30A3●CM12 XX9 30A3●●M12

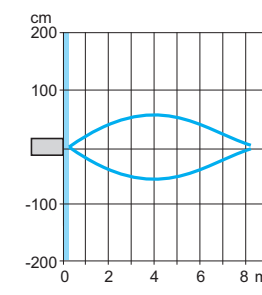

XX2 30A1, XX6 30A1●CM12, XX6 V3A1, XX9 30A1●●M12, XX9 V3A1●●M12

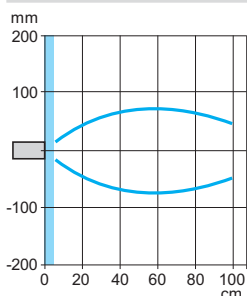

XX7 F1A2●AL01M12

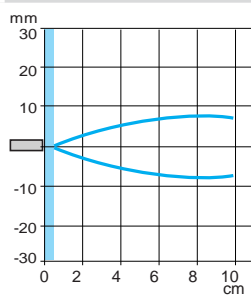

XX7 K1A2●AM12

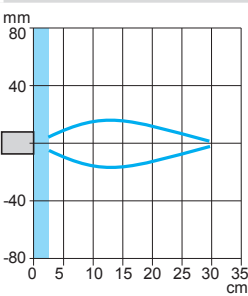

XX2 30A2

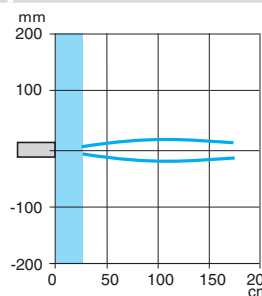

Blind zone

Output signal curve

Sensors with analogue output signal 0...10 V or 4-20 mA

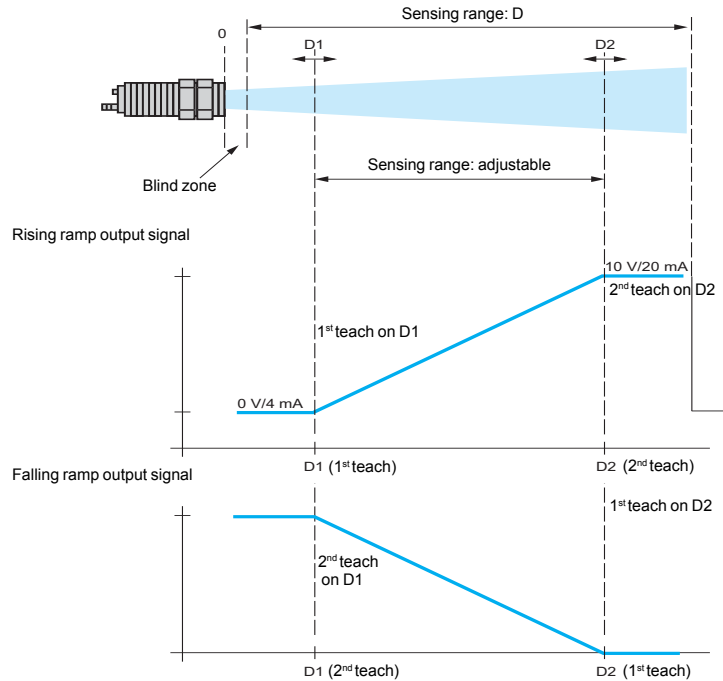

The direction of the slope of the signal is obtained by teaching the first limit:
 - D1 for rising ramp
 - D2 for falling ramp

Maximum deviation < 0.5%

Operating curves

XX2 18A3●H●/XX2 30A●0●

Emptying (stored in high threshold memory)

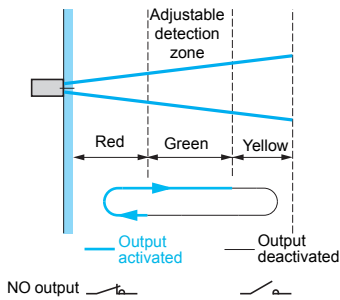

XX2 18A3●F●/XX2 30A●1●

Filling (stored in low threshold memory)

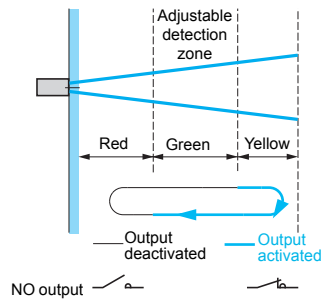

XX2 30A●2●

2 levels, 2 independent outputs

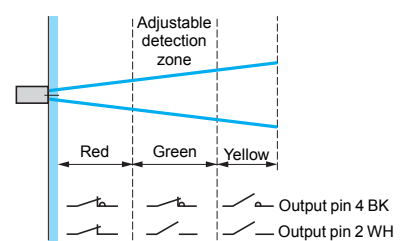

Reminder:

One output is available on the Ø 18 (XX218●)
 Two outputs are available on the Ø 30 (XX230●)

Schneider Electric Industries SAS

Head Office
35, rue Joseph Monier
F-92500 Rueil-Malmaison
France

www.schneider-electric.com

The information provided in this documentation contains general descriptions and/or technical characteristics of the performance of the products contained herein. This documentation is not intended as a substitute for and is not to be used for determining suitability or reliability of these products for specific user applications. It is the duty of any such user or integrator to perform the appropriate and complete risk analysis, evaluation and testing of the products with respect to the relevant specific application or use thereof. Neither Schneider Electric nor any of its affiliates or subsidiaries shall be responsible or liable for misuse of the information contained herein.

Design: Schneider Electric
Photos: Schneider Electric